



Security Tech Germany

GAMME VÉLO

CATALOGUE 2023



L O C K

Avantages du nouveau catalogue 2023

- recherche simplifiée et plus rapide des produits
- les caractéristiques des produits sont visibles en un coup d'oeil



Pour en savoir plus, ouvrez le rabat !

PICTOGRAMMES



Nouveau produit



Nouvelle couleur

ANTIVOLS



Double verrouillage

Double verrouillage de l'anse dans le boîtier



Format de poche

Antivol petit format



Format XL

Antivol grand format



Clé lumineuse

Clé lumineuse contenue dans la livraison



Fermeture sans clé

Ne requiert pas de clé pour la fermeture de l'antivol



Sangle robuste

Tissu high-tech. Résistant aux intempéries et hydrophobe



Code programmable

La combinaison de chiffres peut être choisie librement



Rechargeable

Batterie / pile rechargeable



Batterie / Pile

Batterie / pile incluse



SmartX

Système de verrouillage innovant, contrôlé à l'aide d'un smartphone



XPlus

Cylindre résistant au vol « X Plus »



Poids léger

Antivol léger, idéal pour les activités sportives



Alarme

Antivol offrant une fonction d'alarme à 100 dB



OEM

Les antivols sont fournis sans emballage de vente et offrent ainsi un montage plus rapide. Convient parfaitement pour une utilisation dans des ateliers



Option de clé unique

Fabrication spéciale possible : la même clé peut être utilisée pour plusieurs antivols

CASQUES



Filet anti-moustiques

Protection intégrale contre les insectes



Compatible avec la queue-de-cheval

Casque qui convient parfaitement aux personnes ayant les cheveux longs



Demi-anneau

Demi-anneau ajustable entourant la moitié de la tête, relié au système de serrage



Anneau complet

Anneau ajustable entourant toute la tête, relié au système de serrage



ActiCage

Renforcement structurel intégré à l'EPS pour une stabilité optimale



Taille XL

Casques de grandes tailles disponibles (62+ cm)



Ventilation

Nombre d'aérations entrantes et sortantes



Quin Ready

Le casque peut être équipé du système QUIN



Quin

QUIN est un capteur de détection d'impact qui appelle automatiquement les secours dans les situations d'urgence



SOMMAIRE



WebShop	004
Académie ABUS	006
ABUS - Made in Germany	008
Label de qualité	009
Le smartphone est la clé	010
Antivols en U	012
Antivols pliables	026
Chaînes	044
Antivols Goose	068
Steel-O-Flex	072
Antivols câble en spirale	082
Antivols de cadre et serrures de batterie	098
Sécurités diverses	116
Supports d'antivols et sacoches	144
One Key	164
Service Clé	166
Le système de niveau ABU	168
ABUS OEM	170
Sponsoring	172
Système Quin ABUS	174
Route	176
VTT	202
Urbain	218
Enfants	258
Accessoires de casque	280
Lumino	292
Présentoirs et POS	302
Index des articles	321

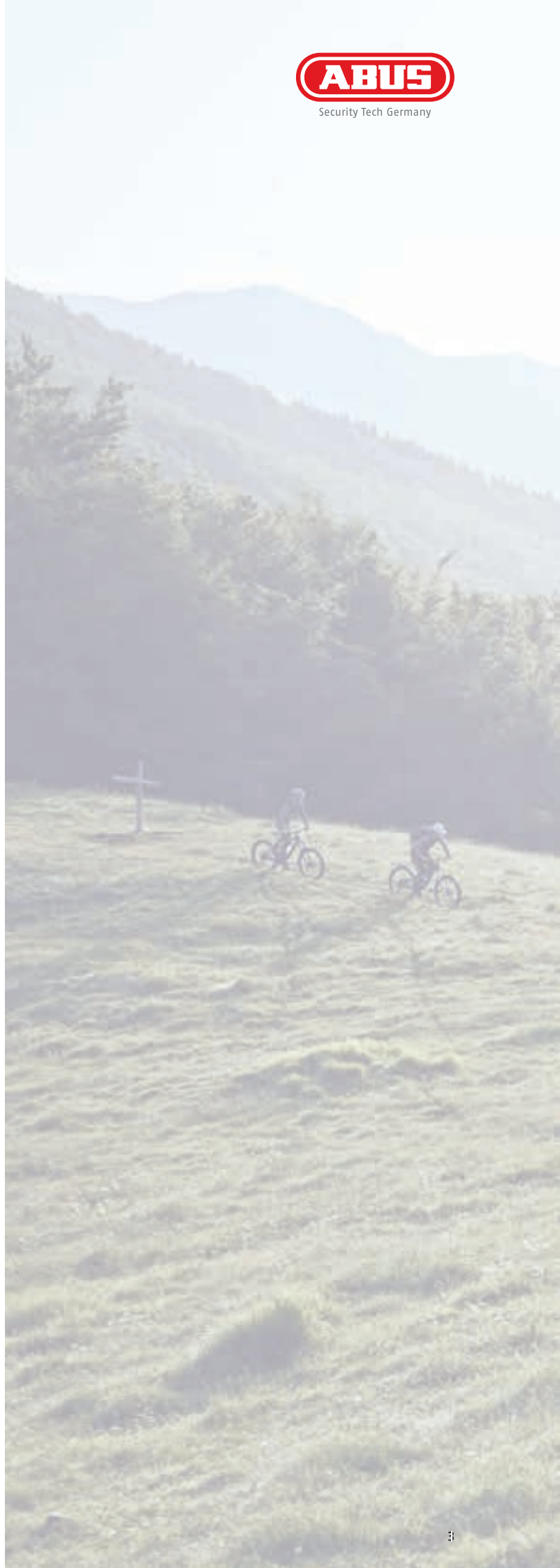

DÉCOUVREZ LE WEBSHOP ABUS [HTTPS://PARTNER-FR.ABUS.COM/](https://partner-fr.abus.com/)



Commander n'a jamais été aussi facile.

Rechercher, cliquer, sélectionner la ou les variantes, ajouter au panier, terminé.

Vous trouverez également des suggestions de produits ou d'accessoires similaires et un tableau comparatif pratique.



NOTE SUR L'INSCRIPTION

Si vous disposez d'un numéro de client et de facture auprès d'ABUS ou si vous avez un mot de passe d'enregistrement, vous pouvez facilement vous inscrire sur notre portail des partenaires d'ABUS et passer des commandes en toute simplicité - à tout moment et de n'importe où.



OPTIMISÉ POUR TOUS LES APPAREILS

Commandez à tout moment et n'importe où. Que ce soit sur une tablette, un smartphone, un ordinateur portable ou un PC, la vue est toujours parfaitement adaptée à votre appareil.

Commandez 24 heures sur 24, où que vous soyez.*



VOS LISTES DE COMMANDES PERSONNELLES

Sur mesure pour vous.

Création de paniers d'achat propres pour les commandes standard.

Vérifiez la disponibilité des produits - de manière simple et fiable.

LES AVANTAGES :

- Retrouvez nos photos produits en qualité d'impression
- Télécharger les brochures actuelles et envoyez-les aux clients par courrier électronique ou imprimez-les
- Concevoir des brochures ou des sites web avec nos images
- Téléchargez des vidéos d'ambiance et d'explication de nos produits pour les diffuser en magasin



POSTES DE COMMANDE OUVERTS

Vous disposez à tout moment d'un aperçu actualisé de vos commandes. Recevez facilement un aperçu à jour de vos commandes en cours.

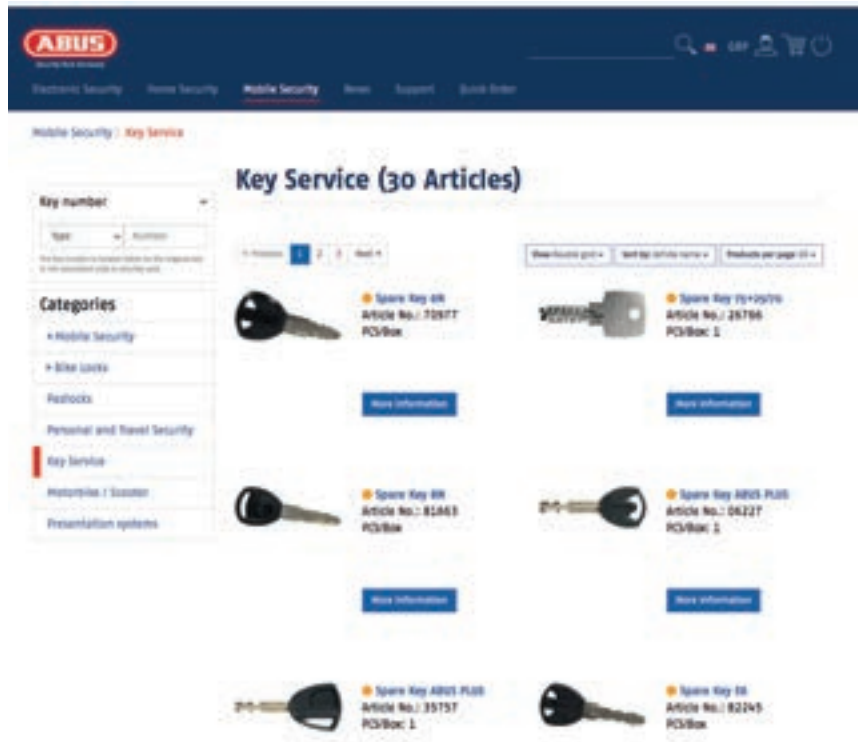

RECHERCHE INTELLIGENTE

Trouvez les produits que vous voulez plus rapidement que jamais. La recherche par texte libre et par mot clé, ainsi que le filtrage en fonction des caractéristiques du produit, vous conduiront plus rapidement et sans détours au produit recherché. Bien entendu, vous pouvez également saisir le numéro d'article ou l'EAN.



SERVICE CLÉ

Commandez facilement des doubles de clés et des clés de remplacement pour vos clients en ligne. Pour ce faire, sélectionnez la bonne ébauche et saisissez le numéro de clé. Nous serons heureux de faire la clé pour vous par la suite.



ÉTIQUETTES PRODUITS

Téléchargez les informations sur les produits et les étiquettes de prix en fonction de votre portefeuille de produits. Vous trouverez des instructions sur la manière de procéder dans la zone de service.



Qu'il s'agisse d'instructions pour le WebShop ou d'instructions pour les produits, vous les trouverez dans l'espace service sous la rubrique „Téléchargements“.

Des photos de produits ainsi que des logos sont également disponibles en téléchargement.

* L'utilisation de dispositifs mobiles peut entraîner des coûts supplémentaires. Si vous avez des questions, veuillez contacter votre fournisseur.



MYAGI - PLATEFORME DE FORMATION NUMÉRIQUE

Découvrez la plateforme de formation pour l'industrie du vélo en direct - des connaissances importantes de première main. Avec un seul login, vous avez accès au contenu de plusieurs fabricants.

CONNAISSANCE DU SECTEUR DE PREMIÈRE MAIN EN TROIS MINUTES

Peu importe quand, comment et où vous voulez approfondir vos connaissances - Myagi est toujours et partout là pour vous.

CONTENUS

- 24/24 et 7/7, toujours et partout accessible (PC, smartphone, tablette)
- Base de connaissances, car les informations sont disponibles à tout moment
- Peut également être utilisé à des fins de formation interne
- Apprentissage court : Les cours sont divisés en leçons de trois minutes
- Conseils de vente pour divers produits sur une seule plateforme

Il suffit de s'inscrire, de jeter un coup d'œil et de commencer : myagi.com/s/abusinternational



DURÉE

Durée de la leçon environ 3 minutes
Un cours se compose de plusieurs leçons.



FRAIS

Gratuit



INSCRIPTION

Dates et inscription sur
myagi.com/s/abusinternational



ABUS - MADE IN GERMANY

À la création de l'entreprise en 1924 par August Bremicker et ses fils, ces derniers possédaient une grande habileté manuelle. – mais aussi une vision : leur objectif était de fabriquer des produits protégeant la vie et les biens des personnes. Une ligne de conduite judicieuse de l'entreprise - associée à une recherche de qualité dès le commencement. C'était le prélude à une réussite continue. La marque ABUS s'est peu à peu imposée en tant que garant en termes de sécurité.



MATÉRIAUX DE HAUTE QUALITÉ

Pour pouvoir offrir une qualité et une sécurité élevées sur la durée, nous utilisons des matériaux de haute qualité dans toutes les gammes de prix. Des processus de durcissement professionnels garantissent une résistance optimale de nos matériaux. Notre service qualité interne vérifie l'ensemble des matériaux avant et pendant le processus de fabrication et assure que chaque produit offre toujours la même qualité supérieure.

LA CLÉ VERS LE SUCCÈS

Chez ABUS nous fabriquons nous-même un grand nombre de machines ainsi que l'ensemble des outils nécessaires pour la production de nos produits de sécurité. Cela permet de réunir savoir-faire, emplois stables et une forte identité. Notre service d'ingénierie et d'outillage canalise son énergie exclusivement sur le développement d'antivols destinés aux vélos et aux motos. Cela nous permet de nous assurer que nous répondons aux exigences élevées en termes de protection contre le vol de vélos et de motos.

NOUS ASSURONS NOTRE PÉRENNITÉ

Dans le laboratoire de contrôle et de tests, nous vérifions régulièrement la résistance de nos antivols afin de pouvoir garantir la qualité constante de nos produits.

Les tests englobent entre autres :

- des vérifications dans une chambre froide à -40°C pour simuler les conditions météorologiques les plus froides et des attaques au spray cryogène
- des simulations réalistes en conditions de vol avec des attaques sur nos antivols par torsion, par traction, par martelage et par sciage
- des vérifications relatives à la longévité et à la résistance dans des milieux hautement corrosifs

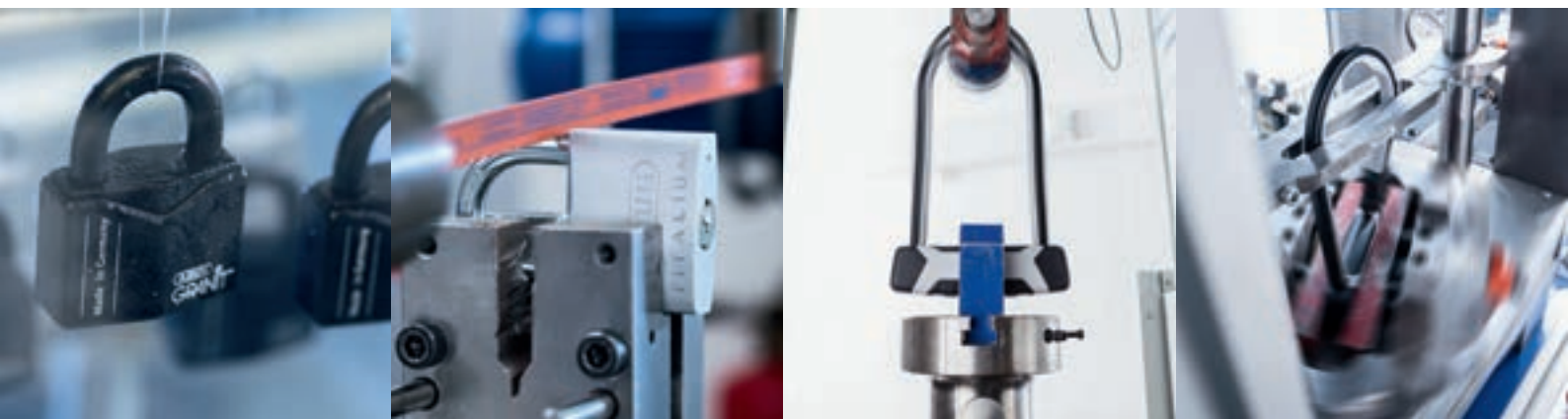

LABEL DE QUALITÉ

Les antivolos ABUS sont testés et reconnus dans des instituts de contrôle indépendants et impartiaux dans de nombreux pays européens. Les labels de qualité suivants confirment le haut niveau de sécurité des antivolos ABUS :



Svensk Brand- och
Säkerhetscertifiering AB
Stockholm, Sweden



Norges Forsikringsforbund
Oslo, Norway



Dansk Varefakta Naevn
Kopenhagen, Danmark



Label de qualité Finanssiala
Helsinki, Finland



ART (ANWB, RAI, Theft Insurers)
The Netherlands



Sold Secure
Rugby, Great Britain



Label de qualité OSIMZ
Moscow, Russia



Label de qualité VdS
Cologne, Germany



ABUS-Label de qualité
der Eisspray-Prüfung
Volmarstein, Germany





LE SMARTPHONE EST LA CLÉ

Ne vis pas dans le passé. Avec les antivols SmartX™, le smartphone devient la clé. Ouverture et fermeture par Bluetooth. Une commodité sans précédent grâce à la toute dernière technologie sans clé - avec la sécurité maximale habituelle.



BLUETOOTH®

Nos produits SmartX™ sont dotés d'un récepteur Bluetooth intégré. C'est sur ce canal codé que l'antivol reçoit les signaux du smartphone – tout aussi sûr que l'antivol lui-même et encore plus unique que n'importe quelle clé.



PLUS BESOIN DE CLÉ

Votre smartphone devient la clé : l'application SmartX d'ABUS (iOS ou Android) est synchronisée à l'antivol par une carte avec un QR code.





APPLICATION SMARTX

Chaque SmartX™ peut être utilisé par plusieurs personnes. L'administrateur décide s'il accorde un accès limité dans le temps ou permanent. Pour le vélo cargo derrière la maison ou la remorque des enfants à la garderie - c'est ainsi que nous définissons la sécurité des biens des familles au 21ème siècle !

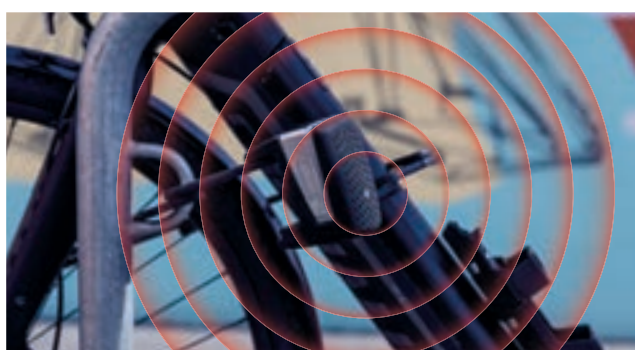

ALERTE

Grâce à la fonction d'alarme intégrée, nos produits SmartX™ offrent une sécurité supplémentaire.

La détection de position 3D détecte les plus petits mouvements et déclenche une alarme dissuasive.

L'antivol n'émet qu'un bref signal sonore lorsqu'il est légèrement touché. Cependant, si les détecteurs identifient une tentative de vol, le volume de l'alarme augmente jusqu'à un niveau assourdissant de 100 décibels.

EN UN COUP D'ŒIL



Sans clé : Ouverture et fermeture par smartphone



Fonction d'alarme sonore de 100 décibels



Rechargeable via USB-C

ANTIVOLS EN U



GRANIT™ POWER 58



black

Page 14

770A SMARTX™



black

Page 15

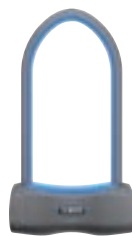

blue

Page 15

GRANIT XPLUS™ 540



black

Page 16

GRANIT™ PLUS 640



red

Page 18



black

Page 18

GRANIT™ PLUS 470



black

Page 19

ULTIMATE 420



red

Page 20

GRANIT™ 460



black

Page 21

440 ALARM



red

Page 22

ULTRA 410



green

Page 23

ULTRA 410 COMBO



green

Page 23



black

Page 23

FACILO 32



black

Page 24

402



yellow

Page 25

GRANIT™ POWER 58

NIVEAU DE SÉCURITÉ



CARACTÉRISTIQUES



XPlus™



SH 58



Platine GIVI M6M



VARIANTES



U 58 SL

DONNÉES TECHNIQUES

- Anse de 16 mm (18 mm avec le revêtement)
- Double verrouillage de l'anse dans le boîtier, contre l'arrachement et qui oblige le voleur à couper les deux côtés de l'anse
- L'anse, le boîtier et certains éléments de fermeture sont en acier spécial cémenté
- Le cylindre ABUS X Plus offre une protection très efficace contre toute tentative de manipulation, comme le crochétage ou le perçage
- Livré avec trois clés
- Couvercle de serrure pour protéger de la corrosion et des saletés
- Livré avec une ABUS Code Card pour la reproduction de clé
- Boîtier ouvert pour éviter la stagnation de l'eau et réduire le risque de corrosion

TECHNOLOGIE



LOGOS D'AGRÈMENT



1) class C

Article	EAN 4003318	mm	mm	mm	Poids g	Unité emb.
58/140HBIII310	32865 7	309	84	18	2580	2
58/140HBIII260	32864 0	259	84	18	2510	2
58/140HBIII100	32863 3	100	84	18	1740	2
58/140HB III 310 SL	54617 4	310	84	18	2850	2
58/140HB III 260 SL	54616 7	260	84	18	2510	2
58/140HB III 230 SL	57164 0	230	84	18	2370	2
58/140HB III 210 SL	57163 3	210	84	18	2270	2
58/140HB III 100 SL	57149 7	100	84	18	1740	2
SH 58	05810 3					3

770A SMARTX™

NIVEAU DE SÉCURITÉ



CARACTÉRISTIQUES



USKF



SmartX RC

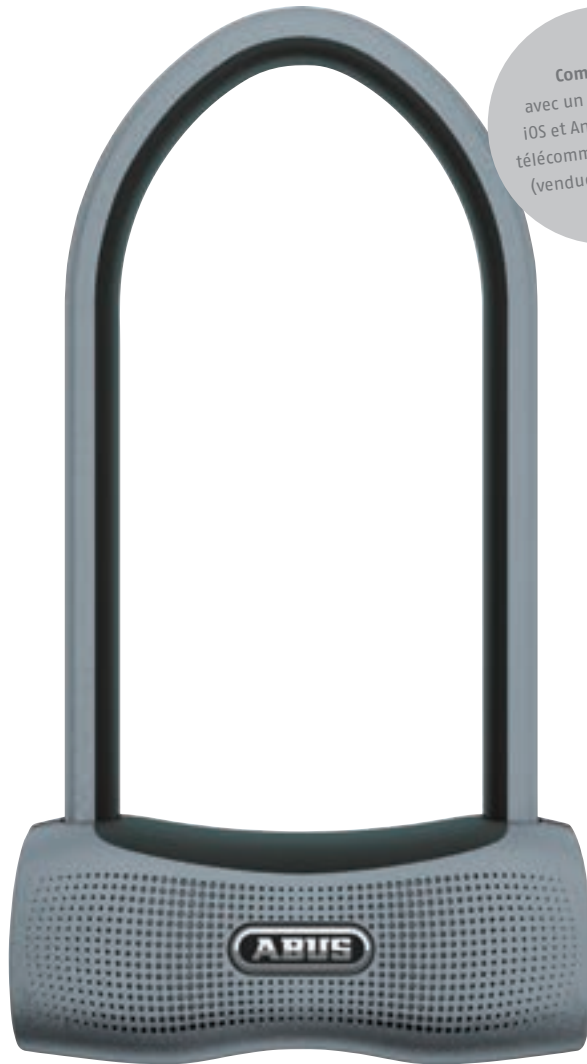

Compatible avec un smartphone iOS et Android ou une télécommande Smart RC (vendue séparément)

VARIANTES



blue

DONNÉES TECHNIQUES

- Anse parabolique carrée en acier cémenté de 13 mm de diamètre
- Système de verrouillage SmartX™ à haute performance avec Bluetooth® – Fonctionnement sans clé, offrant une utilisation simple et pratique
- Alarme de 100 dB pendant 15 secondes
- Fonction d'alarme sur la base du système de détection ABUS 3D – le moindre mouvement est détecté
- Alarme intelligente – En cas de mouvement léger et rapide - par exemple: le vélo est touché par un ballon de football - l'antivol n'émettra qu'une courte tonalité d'alerte
- Port USB-C
- Connexion à l'application ABUS
- Mémorise le dernier lieu de stationnement du vélo / de l'antivol
- La technologie ABUS Power Cell offre une protection très élevée contre les attaques de frappe et de traction
- L'anse, le boîtier et les éléments du mécanisme de verrouillage sont en acier spécial cémenté

TECHNOLOGIE



LOGOS D'AGRÈMENT



Article	EAN 4003318	mm	mm	mm	Poids g	Unité emb.
770A/160HB230 blue SmartX™	84520 8	230	108	17	2000	4
770A/160HB230 blue + USKF SmartX™	84521 5	230	108	17	2150	4
770A/160HB230 black SmartX™	82361 9	230	108	17	2000	4
770A/160HB300 black SmartX™	82362 6	300	108	17	2200	4
770A/160HB230 black + USKF SmartX™	82359 6	230	108	17	2150	4
770A/160HB300 black + USKF SmartX™	82360 2	300	108	17	2350	4
SmartX RC	64000 1				70	1



GRANIT XPLUS™ 540

NIVEAU DE SÉCURITÉ



CARACTÉRISTIQUES



DONNÉES TECHNIQUES

- Anse cémentée parabolique carrée de 13 mm de diamètre: sécurité brevetée
- ABUS Power Cell (breveté) offre une protection très élevée contre les coups et les torsions
- L'anse, le boîtier et certains éléments de fermeture sont en acier spécial cémenté
- Le cylindre ABUS XPlus offre une protection très efficace contre toute tentative de manipulation, comme le crochetage
- Cache-entrée de clé automatique pour protéger de la poussière et de la corrosion

TECHNOLOGIE



LOGOS D'AGRÈMENT



1) 30330

Article	EAN 4003318	mm	mm	mm	Poids g	Unité emb.
540/160HB230	11161 7	230	108	17	1500	6
540/160HB300	11179 2	300	108	17	1700	6
540/160HB230 + USH540	11186 0	230	108	17	1650	5
540/160HB300 + USH540	11188 4	300	108	17	1850	5
540/160HB230 + SH B	69076 1	230	108	17	1650	3
540/160HB300 + SH B	69075 4	300	108	17	1850	3

GRANIT™ PLUS 640

NIVEAU DE SÉCURITÉ



CARACTÉRISTIQUES



Plus



TexKF



VARIANTES



HB150 black



HB230 black

DONNÉES TECHNIQUES

- Anse ronde en acier cémenté de 12 mm de diamètre
- L'anse, le boîtier et certains éléments de fermeture sont en acier spécial cémenté
- Optimisation de la sécurité et du poids grâce à l'emploi de matériaux très légers
- Cylindre ABUS Plus pour une protection élevée contre les manipulations, comme le crochetage

TECHNOLOGIE



LOGOS D'AGRÈMENT



1) 1) seulement pour 72509, 2) 31644

Article	EAN 4003318	mm	mm	mm	Poids g	Unité emb.
640/135HB150 red	39704 2	150	83	15	800	4
640/135HB150 black	39702 8	150	83	15	800	4
640/135HB230 + TexKF black	39703 5	230	83	15	1060	6

GRANIT™ PLUS 470

NIVEAU DE SÉCURITÉ



CARACTÉRISTIQUES

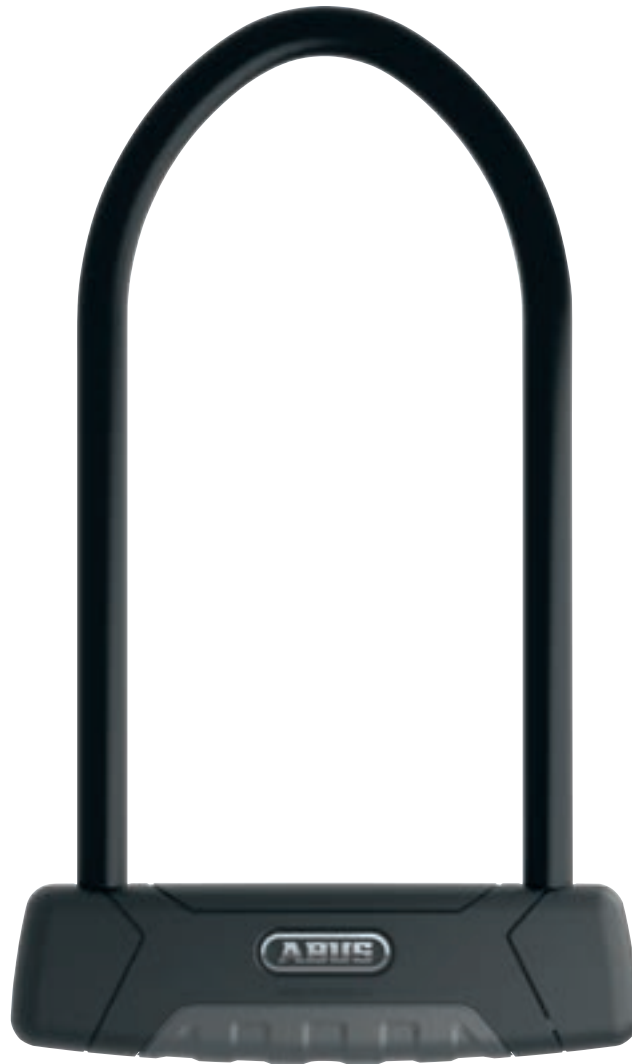

DONNÉES TECHNIQUES

- Anse cémentée parabolique de 12 mm de diamètre
- ABUS Power Cell (breveté) offre une protection très élevée contre les coups et les torsions
- L'anse, le boîtier et certains éléments de fermeture sont en acier spécial cémenté
- Cache-entrée de clé automatique pour protéger de la poussière et de la corrosion

TECHNOLOGIE



LOGOS D'AGRÈMENT



1) 30328

Article	EAN 4003318	mm	mm	mm	Poids g	Unité emb.
470/150HB230 + USH470	11249 2	230	109	14	1260	4
470/150HB300 + USH470	11251 5	300	109	14	1320	5
470/150HB230 + SH B	69073 0	230	109	14	1290	4
470/150HB300 + SH B	69072 3	300	109	14	1350	4

ULTIMATE 420

NIVEAU DE SÉCURITÉ



CARACTÉRISTIQUES



USH



DONNÉES TECHNIQUES

- Anse ronde en acier cémenté de 13 mm de diamètre
- L'anse, le boîtier et les éléments du mécanisme de verrouillage sont en acier spécial cémenté
- La forme ergonomique permet une meilleure manipulation
- Cylindre premium pour une protection élevée contre les manipulations comme le crochetage



TECHNOLOGIE



LOGOS D'AGRÈMENT



1) 33241

Article	EAN 4003318	 mm	 mm	 mm	Poids g	Unité emb.
420/150HB140 + USH Ultimate	81689 5	140	80	17	900	6
420/170HB230 + USH Ultimate	39631 1	230	100	17	1100	6
420/150HB140 + USH + 10/120 Ultimate	81969 8	140	80	17	1240	6
420/170HB230 + USH + 10/120 Ultimate	39633 5	230	100	17	1440	6

GRANIT™ 460

NIVEAU DE SÉCURITÉ



CARACTÉRISTIQUES



USH 460/470



SH B



DONNÉES TECHNIQUES

- Anse cimentée parabolique de 12 mm de diamètre
- L'anse, le boîtier et certains éléments de fermeture sont en acier spécial cimenté
- Cylindre ABUS Extra-Classe

TECHNOLOGIE



LOGOS D'AGRÈMENT



Article	EAN 4003318	mm	mm	mm	Poids g	Unité emb.
460/150HB230 + USH460	11253 9	230	109	14	1000	4
460/150HB300 + USH460	11255 3	300	109	14	1250	5
460/150HB230 + SH B	69070 9	230	109	14	1050	3
460/150HB300 + SH B	69071 6	300	109	14	1300	3

440 ALARM

NIVEAU DE SÉCURITÉ



CARACTÉRISTIQUES



USH



DONNÉES TECHNIQUES



- Anse ronde en acier cémenté de 12 mm de diamètre
- L'anse, le boîtier et les éléments du mécanisme de verrouillage sont en acier spécial cémenté
- La forme ergonomique permet une meilleure manipulation
- Cylindre premium pour une protection élevée contre les manipulations comme le crochetage
- Alarme de 100 dB pendant 15 secondes
- Fonction d'alarme sur la base du système de détection ABUS 3D – le moindre mouvement est détecté
- Une pile CR2 incluse

TECHNOLOGIE



LOGOS D'AGRÈMENT



Article	EAN 4003318	 mm	 mm	 mm	Poids g	Unité emb.
440A/150HB160 USH Alarm	82605 4	160	85	14	1100	6
440A/170HB230 USH Alarm	82606 1	230	108	14	1500	6

ULTRA 410

CARACTÉRISTIQUES



USH 34



NIVEAU DE SÉCURITÉ VARIANTES



410/150HB140

410/150HB140
+10/120410/150HB180
+ 10/120

Article

Article	EAN 4003318	mm	mm	mm	Poids g	Unité emb.
410/150HB140 green SH34	34594 4	140	80	14	755	6
410/150HB140 green SH34 + Cobra 10/120	34596 8	140	80	14	755 + 340	6
410/150HB180 green SH34 + Cobra 10/120	34597 5	180	80	14	835 + 340	6
410/170HB230 green SH34 Ultra	34591 3	230	110	14	1000	6
410/170HB230 green SH34 Ultra + Cobra 10/120	34590 6	230	110	14	1000 + 340	6

DONNÉES TECHNIQUES

- Anse ronde en acier cémenté de 12 mm de diamètre
- L'anse, le boîtier et certains éléments de fermeture sont en acier spécial cémenté
- Forme ergonomique pour une meilleure prise en main
- Cylindre premium pour une protection très efficace contre toute tentative de manipulation, comme le crochetage

TECHNOLOGIE



LOGOS D'AGRÉMENT



ULTRA 410 COMBO

CARACTÉRISTIQUES



USH 34



NIVEAU DE SÉCURITÉ VARIANTES



black

Article

Article	EAN 4003318	mm	mm	mm	Poids g	Unité emb.
410C/170HB230 green SH34 Ultra Combo	86740 8	230	110	14	1150	6
410C/170HB230 black SH34 Ultra Combo	87787 2	230	110	14	1150	6

DONNÉES TECHNIQUES

- Anse ronde en acier cémenté de 12 mm de diamètre
- L'anse, le boîtier et les éléments du mécanisme de verrouillage sont en acier spécial cémenté
- La forme ergonomique permet une meilleure manipulation
- Bonne finition des molettes garantissant une très bonne visibilité des chiffres à long terme
- Programmation individuelle du code

TECHNOLOGIE



LOGOS D'AGRÉMENT



FACILO 32

NIVEAU DE SÉCURITÉ



CARACTÉRISTIQUES



USH 32



VARIANTES



32/150HB230 + 10/120
Loop Cable

DONNÉES TECHNIQUES

- Anse ronde en acier cémenté de 12 mm de diamètre
- Equipé d'un cylindre de qualité ABUS
- Câble en acier 10 mm de haute qualité avec deux boucles
- Recouvert d'un gainage PVC pour protéger le vernis

TECNOLOGIE



LOGOS D'AGRÈMENT



Article	EAN 4003318	 mm	 mm	 mm	Poids g	Unité emb.
32/150HB230 + USH32	37492 0	230	109	15	950	6
32/150HB230 + USH32 + 10/120 Loop Cable	62874 0	230	109	15	950 + 390	6
32/150HB300 + USH32	37887 4	300	109	15	1160	6

NIVEAU DE SÉCURITÉ



CARACTÉRISTIQUES



USH 34



DONNÉES TECHNIQUES



- Anse ronde trempée de 11 mm
- Double verrouillage de l'anse dans le corps de l'antivol
- L'anse, le boîtier et les pièces de support du mécanisme de verrouillage sont fabriqués en acier spécialement cémenté
- La conception spéciale et moderne du boîtier du corps de l'antivol permet une manipulation optimale
- Cylindre de fermeture de haute qualité pour la protection contre la manipulation, par exemple le crochetage
- Quatre clés incluses

TECHNOLOGIE



LOGOS D'AGRÈMENT



Article	EAN 4003318	 mm	 mm	 mm	Poids g	Unité emb.
402/150HB160 yellow SH34 Mini	86741 5	160	90	11	790	6
402/170HB230 yellow SH34	86742 2	230	110	11	890	6

ANTIVOLS PLIABLES



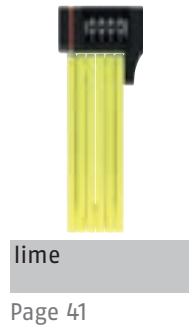
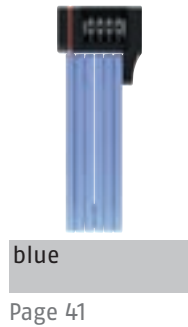
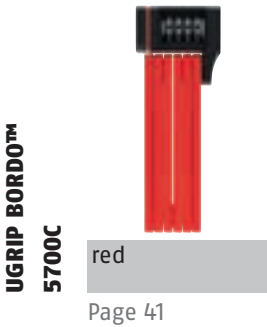
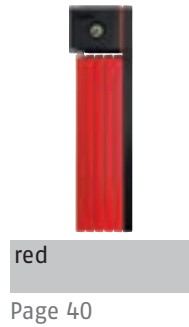
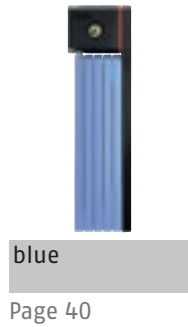
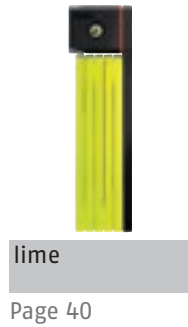
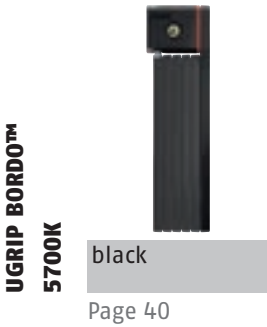

**BORDO™
LITE 6055K**



Movistar Team

Page 42



black

Page 42



red

Page 42

**BORDO™
LITE 6055C**



black

Page 43



red

Page 43



Movistar Team

Page 43



pink SYMBOLS

Page 43



blue SYMBOLS

Page 43



BORDO™ 6500A SMARTX

NIVEAU DE SÉCURITÉ



CARACTÉRISTIQUES



Support SH BORDO
6500A SmartX



SmartX RC



Compatible
avec un smartphone
iOS et Android ou une
télécommande Smart RC
(vendue séparément)

DONNÉES TECHNIQUES

- Barres de 5,5 mm avec revêtement extra-souple à deux composants pour éviter d'endommager la peinture
- SmartX™ système de verrouillage avec Bluetooth - le verrouillage sans clé de haute qualité offre une utilisation simple et pratique
- Fonction d'alarme avec au moins 100 dB pendant 15 secondes, suivie d'une réactivation automatique
- Détection de position 3D - détecte les vibrations et le moindre mouvement dans les trois dimensions et déclenche l'alarme
- Alarme intelligente - l'antivol n'émet qu'un petit signal sonore en cas de chocs faibles et courts, par exemple si un ballon de football heurte le vélo
- Port USB-C
- Connexion à l'application
- Enregistrement du dernier emplacement de stationnement du vélo
- Le voyant LED indique l'état de la batterie et de la charge
- Egalement disponible avec une télécommande (version RC)
- Support SH inclus

TECHNOLOGIE



LOGOS D'AGRÈMENT



Article	EAN 4003318	cm	Poids g	Unité emb.
6500A/110 noir SH SmartX	61495 8	110	2300	3
6500A/110 noir SH RC SmartX	61497 2	110	2320	3
SH 6500A SmartX	63488 8		148	1
SmartX RC	64000 1		70	1

BORDO GRANIT™ 6500KA

NIVEAU DE SÉCURITÉ



CARACTÉRISTIQUES



XPlus™

Support SH 6500K/90



Antivolis pliables

DONNÉES TECHNIQUES

- Barres de 5,5 mm d'épaisseur avec revêtement extra-souple pour protéger contre les dommages à la peinture
- Les barres et le boîtier sont en acier spécialement cémenté
- Fonction alarme avec au moins 100 dB pendant 15 secondes et réactivation automatique subséquente
- Détection d'alarme positionnelle en 3-D - détecte les chocs et les mouvements dans toutes les dimensions
- Alarme intelligente - l'antivol n'émet qu'un petit signal sonore en cas de chocs faibles et courts, par exemple si un ballon de football heurte le vélo
- ABUS Link Protection Shield pour une protection élevée contre les attaques sur les articulations
- Support SH inclus

TECHNOLOGIE



LOGOS D'AGRÈMENT



Article	EAN 4003318	cm	Poids g	Unité emb.
6500KA/90 noir SH	69052 5	90	2020	3
SH 6500K/90	69051 8		195	3

BORDO GRANIT XPLUS™ 6500

NIVEAU DE SÉCURITÉ



CARACTÉRISTIQUES



XPlus™

Support SH 6500/110



DONNÉES TECHNIQUES

- Articulations robustes de 5,5 mm recouvertes d'un gainage pour une bonne protection de la peinture du vélo
- Boîtier recouvert d'une coque en silicone, agréable au toucher
- La technologie ABUS Link-Protection-Shield protège efficacement des tentatives de sciage
- Les articulations, le boîtier et certains éléments de fermeture sont en acier spécial cimenté
- Le cylindre ABUS XPlus offre une protection très efficace contre toute tentative de manipulation, comme le crochetage
- Support SH inclus

TECHNOLOGIE



LOGOS D'AGRÈMENT



1) 20768

Article	EAN 4003318	 cm	Poids g	Unité emb.
6500/110 noir SH	78067 7	110	2332	4
SH 6500/110	61556 6		172	3

BORDO GRANIT™ 6500K

NIVEAU DE SÉCURITÉ



CARACTÉRISTIQUES



XPlus™



Support SH 6500K/90



Support SH 6500K/120



VARIANTES



6500K/120



6500K/90 Twinset

Antivolis pliables

DONNÉES TECHNIQUES

- Barres de 5,5 mm d'épaisseur avec revêtement extra-souple pour protéger contre les dommages à la peinture
- Les barres, le boîtier ainsi que les pièces de support de l'élément de fermeture sont fabriqués en acier spécialement cémenté
- Le Link-Protection-Shield d'ABUS offre une protection élevée au niveau des articulations
- Le cylindre ABUS XPlus offre une protection extrêmement élevée contre le vol, par exemple le crochetage
- Cet antivol peut être fabriqué avec une clé identique à celle d'autres antivolis XPlus grâce au One Key Option
- Support SH inclus

TECHNOLOGIE



LOGOS D'AGRÈMENT



1) 37547

Article	EAN 4003318	cm	Poids g	Unité emb.
6500K/90 noir SH	61498 9	90	1670	4
6500K/90 noir SH TwinSet	61499 6	90	1670 par antivol	2
6500K/120 noir SH	62115 4	120	2470	4
SH 6500K/90	69051 8		195	3
SH 6500K/120	96279 0		230	3

BORDO™ 6000KA

NIVEAU DE SÉCURITÉ



CARACTÉRISTIQUES



XPlus™



Support SH 6000/90



Support SH 6000/120



VARIANTES



6000KA/120 BK SH

DONNÉES TECHNIQUES

- Barres de 5 mm d'épaisseur avec revêtement extra souple pour protéger contre les dommages causés par la peinture
- Les barres et le boîtier sont en acier spécialement cémenté
- Fonction alarme avec au moins 100 dB pendant 15 secondes et réactivation automatique subséquente
- Détection de position 3D - détecte les vibrations et les moindres mouvements dans les trois dimensions et déclenche l'alarme
- Alarme intelligente - l'antivol n'émet qu'un petit signal sonore en cas de chocs faibles et courts, par exemple si un ballon de football heurte le vélo
- Des signaux sonores indiquent l'état de la pile et de l'activité
- Connexion des barres par des rivets spéciaux
- Cylindre ABUS XPlus offre une protection extrêmement élevée contre le vol, par exemple le crochetage
- Support SH inclus

TECHNOLOGIE



LOGOS D'AGRÈMENT



Article	EAN 4003318	cm	Poids g	Unité emb.
6000KA/90 noir SH	61500 9	90	1450	4
6000KA/120 noir SH	62090 4	120	1700	4
SH 6000/90	61543 6		115	3
SH 6000/120	61564 1		132	3

BORDO™ 6000K

NIVEAU DE SÉCURITÉ



CARACTÉRISTIQUES



XPlus™



Support SH 6000/90



Support SH 6000/120



Support SH SF



VARIANTES



6000K/120



6000K/90 TwinSet



6000K/120 TwinSet

Antivols pliables

DONNÉES TECHNIQUES

- Barres de 5 mm d'épaisseur avec revêtement extra souple pour protéger contre les dommages causés par la peinture
- Les barres et le boîtier sont fabriqués en acier spécialement trempé
- Connexion des barres par des rivets spéciaux
- Le cylindre ABUS XPlus offre une protection extrêmement élevée contre le vol, par exemple le crochetage
- Support SH inclus

TECHNOLOGIE



LOGOS D'AGRÈMENT



1) 37545

Article	EAN 4003318	cm	Poids g	Unité emb.
6000K/90 noir SH	62094 2	90	1207	4
6000K/90 noir SH TwinSet	62095 9	90	1207 par antivols	2
6000K/90 noir SH SF	67865 3	90	1330	4
6000K/90 noir SHFL	90973 3	90	1330	4
6000K/120 noir SH	62091 1	120	1546	4
6000K/120 noir SH TwinSet	67465 5	120	1546 par antivols	2
SH 6000/90	61543 6		115	3
SH SF	67866 0		121	3
SH 6000/120	61564 1		132	3
SHFL 6000/90	88886 1		160	3

BORDO™ 6000PZ

NIVEAU DE SÉCURITÉ



CARACTÉRISTIQUES



Support SH 6000/90



DONNÉES TECHNIQUES

- Barres de 5 mm d'épaisseur avec un revêtement extra souple à 2 composants pour protéger contre les dommages à la peinture
- Les barres et le boîtier sont en acier spécialement cémenté
- Connexion des barres par des rivets spéciaux
- Capot manuel contre la saleté
- Convient à divers demi-cylindres

LOGOS D'AGRÈMENT



Article	EAN 4003318	 cm	Poids g	Unité emb.
6000PZ/90 noir SH EC550	40663 8	90	1662	3
6000PZ/90 noir SH ohne Zylinder	61478 1	90	1531	3
SH 6000/90	61543 6		115	3

BORDO 6000PZ : L'ANTIVOL POUR VÉLO AVEC LA CLÉ DE LA MAISON

Comme aucune autre entreprise, ABUS est synonyme de sécurité - à la maison ou sur la route. Aujourd'hui, ABUS combine ces deux mondes en un seul produit et présente une véritable nouveauté avec le BORDO 6000PZ :

L'antivol pliant éprouvé est désormais disponible avec un cylindre profilé : Le premier antivol pour vélo qui peut être ouvert avec la clé de la porte d'entrée.

Une clé pour tout ce qui doit être sécurisé.



DE NOMBREUSES APPLICATIONS - 1 CLÉ.

C'est très simple :

Le client souhaite que la clé de son Bordo soit la même que celle de sa porte d'entrée ? C'est facile à faire maintenant.

1. Soit le BORDO correspondant est fabriqué pour le cylindre existant de la porte d'entrée, soit le cylindre de la porte d'entrée est adapté au BORDO.
2. Faites tout fonctionner avec une seule clé !



BORDO™ 6000C

NIVEAU DE SÉCURITÉ



CARACTÉRISTIQUES



Support SH 6000/90



Support SHFL 6000/90



Support SH SF

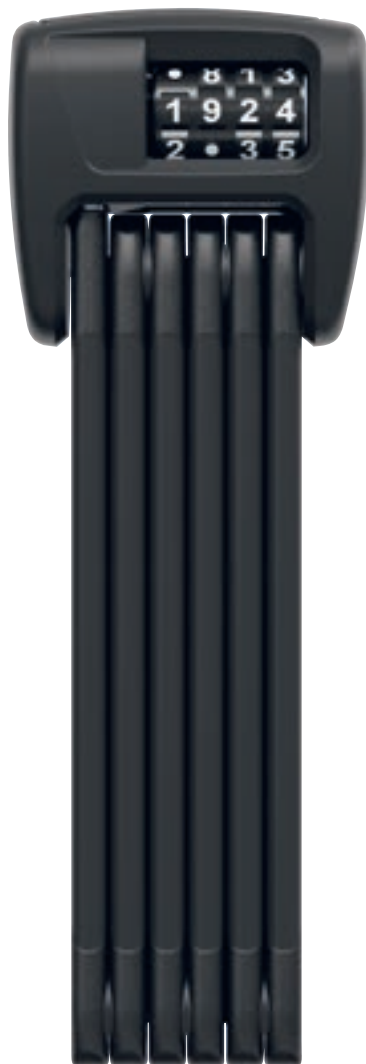

DONNÉES TECHNIQUES

- Barres de 5 mm d'épaisseur avec revêtement extra souple pour protéger contre les dommages causés par la peinture
- Les barres et le boîtier sont fabriqués en acier spécialement cémenté
- Connexion des barres par des rivets spéciaux
- Les molettes à 2 composants assurent une lisibilité permanente des numéros
- Code à chiffres réglable individuellement
- Support SH inclus

TECHNOLOGIE



LOGOS D'AGRÈMENT



Article	EAN 4003318	 cm	Poids g	Unité emb.
6000C/90 noir SH	67599 7	90	1050	4
6000C/90 noir SH SF	69069 3	90	1170	4
6000C/90 noir SHFL	90972 6	90	1050	4
SH 6000/90	61543 6		115	3
SHFL 6000/90	88886 1		160	3
SH SF	67866 0		121	3

BORDO™ 6000C LED

NIVEAU DE SÉCURITÉ



CARACTÉRISTIQUES



LED



Support SH 6000/90

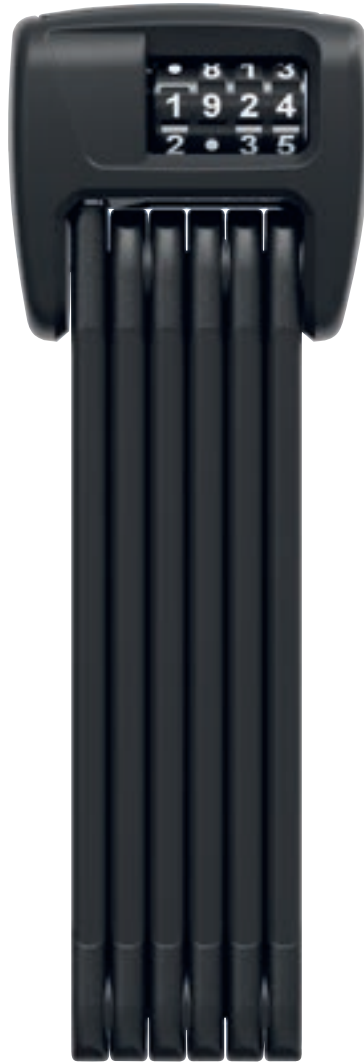

Antivolis pliables

DONNÉES TECHNIQUES

- Barres de 5 mm d'épaisseur avec revêtement extra souple pour protéger contre les dommages causés par la peinture
- Les barres et le boîtier sont fabriqués en acier spécialement trempé
- Connexion des barres par des rivets spéciaux
- Lampe LED intégrée pour l'éclairage des molettes
- Une pile bouton CR1220 pour alimenter la lampe LED est incluse
- Les molettes à 2 composants assurent une lisibilité permanente des numéros
- Code à chiffres réglable individuellement
- Support SH inclus

TECHNOLOGIE



LOGOS D'AGRÈMENT



Article	EAN 4003318	 cm	Poids g	Unité emb.
6000C/90 LED noir SH	69057 0	90	1050	4
SH 6000/90	61543 6		115	3

UGRIP BORDO™ 5700K

NIVEAU DE SÉCURITÉ



CARACTÉRISTIQUES



Support SH 5700/80



Support SH 5700K/100



VARIANTES



5700K/100 lime



5700K/80 lime



5700K/100 bleu



5700K/80 bleu



5700K/100 rouge



5700K/80 rouge



5700K/100 noir

DONNÉES TECHNIQUES

- Articulations en acier de 5 mm
- Boîtier de couleur assortie (uniquement pour les couleurs „core“)
- Les articulations sont reliées entre elles par des rivets spéciaux
- Cylindre automatique premium
- Le mode de transport pratique (CTM) fournit une utilisation immédiate de l'antivol (uniquement pour 5700/100)

TECHNOLOGIE



LOGOS D'AGRÈMENT



Article	EAN 4003318	 cm	Poids g	Unité emb.
5700K/80 noir SH	84425 6	80	960	6
5700K/80 lime SH	84427 0	80	960	6
5700K/80 bleu SH	84426 3	80	960	6
5700K/80 rouge SH	84428 7	80	960	6
5700K/100 noir SH	86743 9	100	1090	6
5700K/100 lime SH	86745 3	100	1090	6
5700K/100 bleu SH	86744 6	100	1090	6
5700K/100 rouge SH	86746 0	100	1090	6
SH 5700/80	61566 5		122	3
SH 5700K/100	61571 9		122	3

UGRIP BORDO™ 5700 COMBO

NIVEAU DE SÉCURITÉ



CARACTÉRISTIQUES



Support SH 5700/80

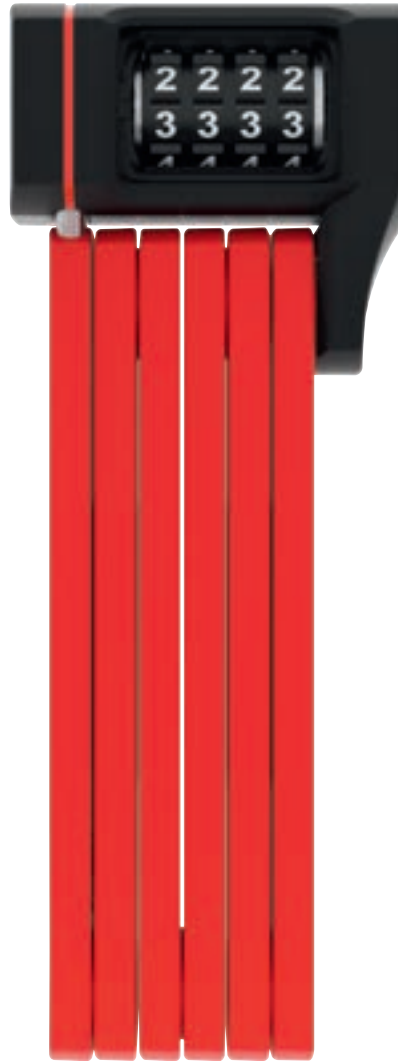

VARIANTES



5700C/80 noir

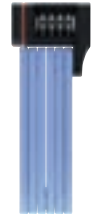

5700C/80 bleu



5700C/80 lime

Antivols pliables

DONNÉES TECHNIQUES

- Articulations en acier de 5 mm
- Les articulations sont reliées entre elles par des rivets spéciaux
- Les molettes à 2 composants assurent une lisibilité permanente de numéros
- Programmation individuelle du code

TECHNOLOGIE



LOGOS D'AGRÈMENT



Article	EAN 4003318	 cm	Poids g	Unité emb.
5700C/80 noir SH	87791 9	80	960	6
5700C/80 bleu SH	87792 6	80	960	6
5700C/80 lime SH	87793 3	80	960	6
5700C/80 rouge SH	87794 0	80	960	6
SH 5700/80	61566 5		122	3

BORDO™ LITE 6055K

NIVEAU DE SÉCURITÉ



CARACTÉRISTIQUES



Support SH 6055



Support SR 6055



VARIANTES



noir



noir



rouge



rouge

DONNÉES TECHNIQUES

- Barres de 5 mm d'épaisseur avec revêtement extra souple pour protéger contre les dommages causés par la peinture
- Les articulations et le boîtier sont fabriqués dans un matériau très léger et composés d'acier
- Les articulations sont reliées entre elles par des rivets
- Cylindre automatique premium
- Le BORDO Lite Mini se range facilement dans les poches de votre maillot

TECHNOLOGIE



LOGOS D'AGRÈMENT



Article	EAN 4003318	 cm	Poids g	Unité emb.
6055K/60 noir	78060 8	60	400	6
6055K/60 noir SH	62102 4	60	500	6
6055K/60 noir SR	62103 1	60	500	4
6055K/60 rouge	78061 5	60	400	6
6055K/60 MOVISTAR TEAM	78062 2	60	400	6
6055K/85 noir SH	78063 9	85	550	6
6055K/85 noir SR	62104 8	85	550	4
6055K/85 rouge SH	78064 6	85	550	6
SH 6055	61572 6		60	3
SR 6055 Selle Royal	63151 1		64	3

BORDO™ LITE 6055C

NIVEAU DE SÉCURITÉ



CARACTÉRISTIQUES



Support SR 6055



Support SH 6055



VARIANTES



noir



bleu Symbols



rouge



rouge



Movistar



pink Symbols

Antivolis pliables

DONNÉES TECHNIQUES

- Barres de 5 mm d'épaisseur avec revêtement extra souple pour protéger contre les dommages causés par la peinture
- Les barres et le boîtier sont fabriqués à partir de matériaux particulièrement légers et d'alliages d'acier
- Barres reliées par des rivets spéciaux
- Les molettes à 2 composants assurent une lisibilité permanente de numéros
- Code configurable individuellement
- Un rapport sécurité-poids parfait
- Avec support (SH ou SR)

TECHNOLOGIE



LOGOS D'AGRÈMENT



Article	EAN 4003318	cm	Poids g	Unité emb.
6055C/60 noir	62105 5	60	460	6
6055C/60 noir SH	62110 9	60	550	6
6055C/60 noir SR	62114 7	60	550	4
6055C/60 rouge	62106 2	60	460	6
6055C/60 MOVISTAR TEAM	62107 9	60	460	6
6055C/60 pink SYMBOLS	62108 6	60	460	6
6055C/60 bleu SYMBOLS	62109 3	60	460	6
6055C/85 noir SH	62111 6	85	708	6
6055C/85 noir SR	62113 0	85	708	4
6055C/85 rouge SH	62112 3	85	708	6
SH 6055	61572 6		60	3
SR 6055 Selle Royal	63151 1		64	3

CHAÎNES



**GRANIT CITYCHAIN
XPLUS™ 1060**



black

Page 48

**IVY CHAIN
9210**



black

Page 49

**CITYCHAIN™
1010**



black

Page 50

**STEEL-O-CHAIN™
9809K**



black

Page 51

**STEEL-O-CHAIN™
9808K**



black

Page 52

8808C



black

Page 53



russet red

Page 53



jade green

Page 53

**IVEN CHAIN
8210**



black

Page 54

**IVERA CHAIN
7210 COLOR**



racing yellow

Page 55



diving blue

Page 55



crossing grey

Page 55



sparkling orange

Page 55

**IVERA CHAIN
7210**



black

Page 55

**STEEL-O-CHAIN™
8807K**



black

Page 56

**TRESOR
1385**



black

Page 57



aqua

Page 57



coral

Page 57



brown

Page 57

**TRESOR
1385 COLOR**



Neon blue

Page 58



black

Page 58



Neon green

Page 58



Neon orange

Page 58



Neon pink

Page 58

**TRESOR
1385 COLOR**



grey star

Page 58

blue mask

Page 58

grey lightning

Page 58

cherry heart

Page 58

**CATENA
6806K**

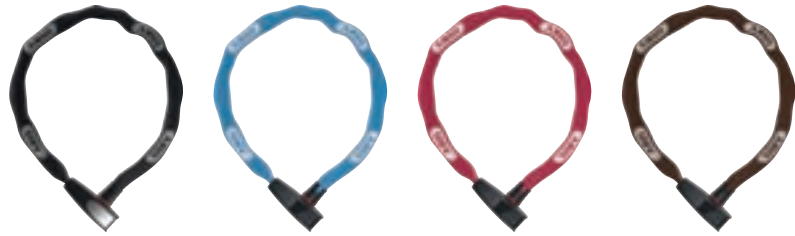

black

Page 59

aqua

Page 59

coral

Page 59

brown

Page 59

**CATENA
6806K NEON**



Neon pink

Page 59

Neon green

Page 59

Neon blue

Page 59

Neon orange

Page 59

**CATENA
6806K COLOR**



cherry heart

Page 60

blue mask

Page 60

grey lightning

Page 60

grey star

Page 60

**CATENA
6806K REFLECTIVE**



reflective

Page 61

6806K CLASSIC



black

Page 62

**STEEL-O-CHAIN™
5805K**

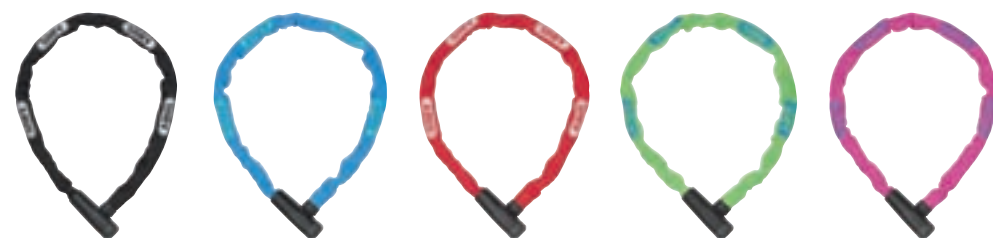

black

Page 63

blue

Page 63

red

Page 63

lime

Page 63

pink

Page 63

**STEEL-O-CHAIN™
5805C**

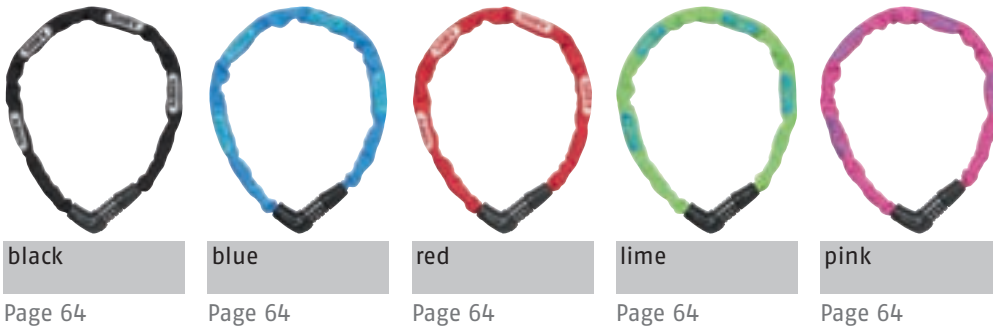

**STEEL-O-CHAIN™
4804K**

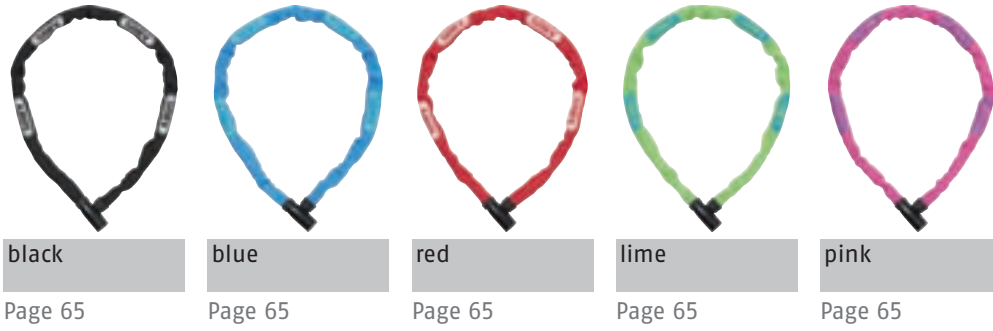

**STEEL-O-CHAIN™
4804C SYMBOLS**



**STEEL-O-CHAIN™
4804C**

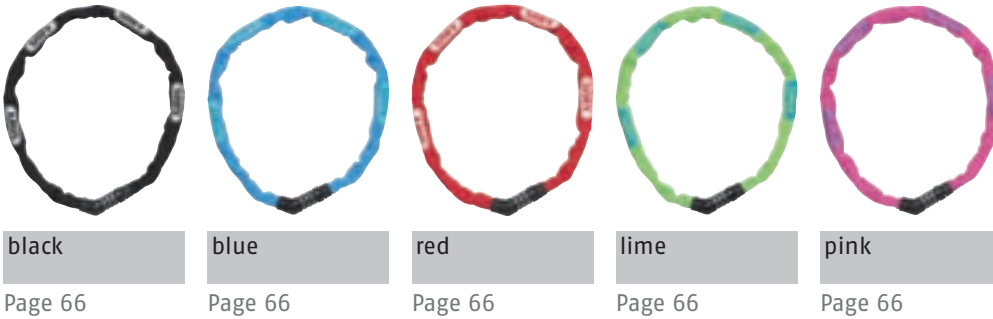

1500 WEB

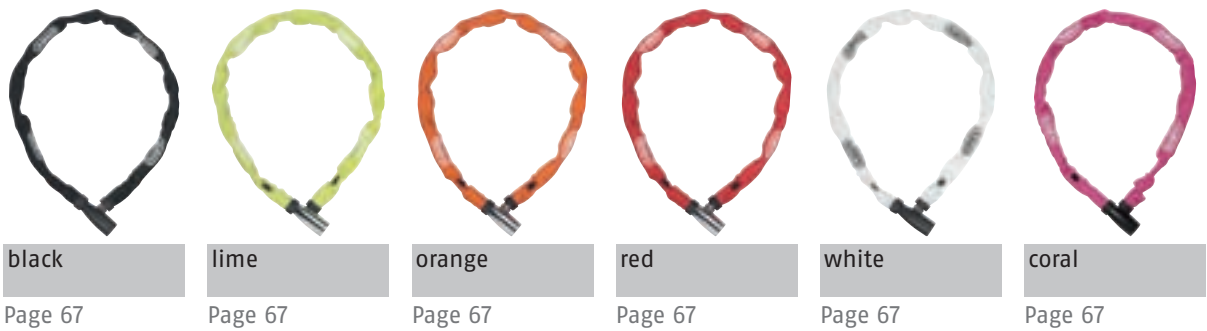

1200 WEB

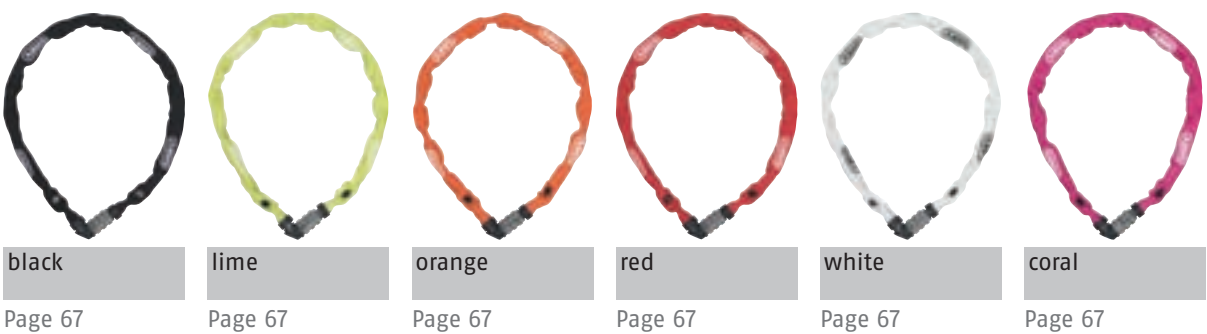

GRANIT CITYCHAIN XPLUS™ 1060

NIVEAU DE SÉCURITÉ



CARACTÉRISTIQUES



DONNÉES TECHNIQUES

- Chaîne à maillons hexagonale de 10 mm recouverte d'un gainage en tissu pour protéger la peinture du vélo
- La technologie ABUS Power Cell brevetée offre une protection très élevée contre les coups et les torsions
- Power Link Technology offre un verrouillage direct de la chaîne au boîtier Power Cell et augmente ainsi son efficacité
- Construction emboîtée du corps pour une protection élevée contre toutes sortes d'attaques brutales
- La chaîne, le boîtier et certains éléments de fermeture sont en acier spécial cimenté
- Le cylindre ABUS XPlus offre une protection extrêmement élevée contre le vol, par exemple le crochetage
- Cache-entrée de clé automatique pour protéger de la poussière et de la corrosion

TECHNOLOGIE



LOGOS D'AGRÈMENT



1) Class C 2) 17218

Article	EAN 4003318	Ø mm	l cm	Poids g	Unité emb.
1060/85 black	28678 0	10	85	2100	2
1060/110 black	28623 0	10	110	2650	2
1060/140 black	28624 7	10	140	3260	2
1060/170 black	28625 4	10	170	3750	2

IVY CHAIN 9210

NIVEAU DE SÉCURITÉ



CARACTÉRISTIQUES



DONNÉES TECHNIQUES



- Chaîne à maillons hexagonale de 10 mm recouverte d'un gainage en tissu pour protéger la peinture du vélo
- La chaîne, le boîtier et certains éléments de fermeture sont en acier spécial cémenté
- Verrouillage ergonomique du boîtier
- Équipé d'une clé reversible, facile à utiliser

TECHNOLOGIE



LOGOS D'AGRÈMENT



Article	EAN 4003318	 mm	 cm	Poids g	Unité emb.
9210/85 black	88691 1	10	85	2440	2
9210/110 black	88692 8	10	110	3000	2
9210/140 black	88693 5	10	140	3650	1
9210/170 black	88694 2	10	170	4400	1

CITYCHAIN™ 1010

NIVEAU DE SÉCURITÉ



CARACTÉRISTIQUES



Plus



DONNÉES TECHNIQUES

- Chaîne à maillons hexagonale de 9 mm recouverte d'un gainage en tissu pour protéger la peinture du vélo
- La chaîne, le boîtier et certains éléments de fermeture sont en acier spécial cémenté
- Le cylindre ABUS XPlus offre une protection extrêmement élevée contre le vol, par exemple le crochetage
- Equipée d'un cache-entrée de clé automatique pour protéger de la poussière et de la corrosion



TECHNOLOGIE



LOGOS D'AGRÈMENT



1) Class B

Article	EAN 4003318	 mm	 cm	Poids g	Unité emb.
1010/85 black	33559 4	9	85	1850	2
1010/110 black	12042 8	9	110	2200	2
1010/140 black	12527 0	9	140	2650	2
1010/170 black	12528 7	9	170	3200	2

STEEL-O-CHAIN™ 9809K

NIVEAU DE SÉCURITÉ



CARACTÉRISTIQUES



Chaînes

DONNÉES TECHNIQUES

- Chaîne à maillons carrés de 9 mm recouverte d'un gainage en tissu pour protéger la peinture du vélo
- La chaîne, le boîtier et les pièces de support du mécanisme de verrouillage sont fabriqués en acier spécialement cémenté
- Couverture automatique du trou de serrure contre les salissures et la corrosion
- Le cylindre ABUS XPlus offre une protection extrêmement élevée contre le vol, par exemple le crochetage

TECHNOLOGIE



Article	EAN 4003318	⌀ mm	----- cm	Poids g	Unité emb.
9809K/85 black	95548 8	9	85	2130	2
9809K/110 black	95549 5	9	110	2510	2
9809K/140 black	95550 1	9	140	2890	2
9809K/170 black	95551 8	9	170	3270	2

STEEL-O-CHAIN™ 9808K

NIVEAU DE SÉCURITÉ



CARACTÉRISTIQUES



DONNÉES TECHNIQUES

- Chaîne à maillons carrés de 8 mm d'épaisseur
- La chaîne, le boîtier et les pièces de support du mécanisme de verrouillage sont fabriqués en acier spécialement cémenté
- Couverture automatique du trou de serrure contre les salissures et la corrosion
- Le cylindre ABUS XPlus offre une protection extrêmement élevée contre le vol, par exemple le crochetage

TECHNOLOGIE



Article	EAN 4003318	⌀ ↑ mm	----- cm	Poids g	Unité emb.
9808K/85 black	95562 4	8	85	1750	2
9808K/110 black	95564 8	8	110	2250	2
9808K/140 black	95565 5	8	140	2800	2
9808K/170 black	95566 2	8	170	3050	2

8808C

NIVEAU DE SÉCURITÉ



VARIANTES



russet red



jade green



Chaînes

DONNÉES TECHNIQUES

- Chaîne à maillons de 8 mm recouverte d'un gainage en tissu pour protéger la peinture du vélo
- La chaîne est fabriquée en acier spécialement cémenté
- Les molettes à deux composantes assurent une lisibilité des numéros à long terme
- Code configurable individuellement

TECHNOLOGIE



Article	EAN 4003318	 mm	 cm	Poids g	Unité emb.
8808C/85 black	61490 3	8	85	1990	2
8808C/85 russet red	61491 0	8	85	1990	2
8808C/85 jade green	61492 7	8	85	1990	2
8808C/110 black	61494 1	8	110	2370	2

IVEN CHAIN 8210

NIVEAU DE SÉCURITÉ



CARACTÉRISTIQUES



DONNÉES TECHNIQUES

- Chaîne à maillons carrés de 8 mm de diamètre recouverte d'un gainage en tissu pour protéger la peinture du vélo
- La chaîne, le boîtier et certains éléments de fermeture sont en acier spécial cémenté



TECHNOLOGIE



LOGOS D'AGRÈMENT



1) 24192

Article	EAN 4003318	 mm	 cm	Poids g	Unité emb.
8210/85 black	55152 9	8	85	1800	2
8210/110 black	55153 6	8	110	2200	2
8210/140 black	88288 3	8	140	3185	2

IVERA CHAIN 7210 COLOR

CARACTÉRISTIQUES



IVERA RBU



DONNÉES TECHNIQUES

- Chaîne à maillons carrés de 7 mm de diamètre avec un maillage fonctionnel, très flexible et durable pour éviter d'endommager la peinture du vélo
- La gaine offre une très grande protection contre l'abrasion et n'absorbe aucun liquide, comme par exemple l'eau ou l'huile
- La chaîne, le boîtier et les éléments du mécanisme de verrouillage sont en acier spécial cémenté

NIVEAU DE SÉCURITÉ VARIANTES



diving blue



crossing grey



sparkling orange



TECHNOLOGIE

Article	EAN 4003318	⌀ mm	----- cm	Poids g	Unité emb.
7210/85 sparkling orange	87777 3	7	85	1300	2
7210/85 racing yellow	87778 0	7	85	1300	2
7210/85 diving blue	87779 7	7	85	1300	2
7210/85 crossing grey	87780 3	7	85	1300	2
7210/110 sparkling orange	87783 4	7	110	1500	2
7210/110 racing yellow	87782 7	7	110	1500	2
7210/110 diving blue	87784 1	7	110	1500	2
7210/110 crossing grey	87781 0	7	110	1500	2
RBU IVERA	58497 8			125	1

IVERA CHAIN 7210

CARACTÉRISTIQUES



IVERA RBU



DONNÉES TECHNIQUES

- Chaîne à maillons carrés de 7 mm de diamètre recouverte d'un gainage en tissu pour protéger la peinture du vélo
- La gaine offre une très grande protection contre l'abrasion et n'absorbe aucun liquide, comme par exemple l'eau ou l'huile
- La chaîne, le boîtier et certains éléments de fermeture sont en acier spécial cémenté

NIVEAU DE SÉCURITÉ



TECHNOLOGIE

Article	EAN 4003318	⌀ mm	----- cm	Poids g	Unité emb.
7210/85	55141 3	7	85	1300	2
7210/110	55142 0	7	110	1500	2
RBU IVERA	58497 8			125	1

STEEL-O-CHAIN™ 8807K

NIVEAU DE SÉCURITÉ



CARACTÉRISTIQUES



DONNÉES TECHNIQUES



- Chaîne à maillons carrés de 7 mm de diamètre recouverte d'un gainage en tissu pour protéger la peinture du vélo
- La chaîne, le boîtier et certains éléments de fermeture sont en acier spécial cémenté

TECHNOLOGIE



LOGOS D'AGRÈMENT



Article	EAN 4003318	 mm	 cm	Poids g	Unité emb.
8807K/85 black	71195 4	7	85	1600	2
8807K/110 black	82519 4	7	110	1900	2

TRESOR 1385

NIVEAU DE SÉCURITÉ



VARIANTES



aqua



coral



brown



Chaînes

DONNÉES TECHNIQUES

- Chaîne à maillons carrés de 7 mm de diamètre recouverte d'un gainage en tissu pour protéger la peinture du vélo
- La chaîne est en acier special cémenté
- Bonne finition des molettes garantissant une très bonne visibilité des chiffres à long terme
- Les molettes à 2 composantes assurent une lisibilité permanente de numéros
- Programmation individuelle du code

TECHNOLOGIE



Article	EAN 4003318	 mm	 cm	Poids g	Unité emb.
1385/85 black	48566 4	7	85	1050	2
1385/85 aqua	48567 1	7	85	1050	2
1385/85 coral	48568 8	7	85	1050	2
1385/85 brown	48569 5	7	85	1050	2
1385/110 black	48628 9	7	110	1350	2

TRESOR 1385 COLOR

NIVEAU DE SÉCURITÉ



VARIANTES



DONNÉES TECHNIQUES

- Chaîne à maillons carrés de 6 mm de diamètre recouverte d'un gainage en tissu pour protéger la peinture du vélo
- La chaîne est en acier special cémenté
- Bonne finition des molettes garantissant une très bonne visibilité des chiffres à long terme
- Les molettes à 2 composantes assurent une lisibilité permanente de numéros
- Programmation individuelle du code

TECHNOLOGIE



Article	EAN 4003318	⌀ mm	●●●● cm	Poids g	Unité emb.
1385/75 grey star	88010 0	6	75	750	6
1385/75 blue mask	88011 7	6	75	750	6
1385/75 grey lightning	88012 4	6	75	750	6
1385/75 cherry heart	88013 1	6	75	750	6
1385/75 black	51133 2	6	75	750	6
1385/75 neon green	71263 0	6	75	750	6
1385/75 neon blue	71262 3	6	75	750	6
1385/75 neon orange	71264 7	6	75	750	6
1385/75 neon pink	71265 4	6	75	750	6

CATENA 6806K

CARACTÉRISTIQUES



Support QST



DONNÉES TECHNIQUES

- Chaîne à maillons carrés de 6 mm de diamètre recouverte d'un gainage en tissu pour protéger la peinture du vélo
- La chaîne est en acier special cémenté

TECHNOLOGIE



NIVEAU DE SÉCURITÉ VARIANTES



aqua



coral



brown

Article

Article	EAN 4003318	mm	cm	Poids g	Unité emb.
6806K/85 black	90169 0	6	85	920	6
6806K/85 black QST	95483 2	6	85	1150	6
6806K/85 aqua	90282 6	6	85	920	6
6806K/85 coral	90284 0	6	85	920	6
6806K/85 brown	90283 3	6	85	920	6
6806K/110 black	82511 8	6	110	1160	6
6806K/110 black QST	95479 5	6	110	1360	6

CATENA 6806K NEON

CARACTÉRISTIQUES



Support QST



DONNÉES TECHNIQUES

- Chaîne à maillons carrés de 6 mm de diamètre recouverte d'un gainage en tissu pour protéger la peinture du vélo
- La chaîne est en acier special cémenté

TECHNOLOGIE



NIVEAU DE SÉCURITÉ VARIANTES



neon green



neon blue



neon orange

Article

Article	EAN 4003318	mm	cm	Poids g	Unité emb.
6806K/85 neon green	90290 1	6	85	920	6
6806K/85 neon blue	90289 5	6	85	920	6
6806K/85 neon orange	90291 8	6	85	920	6
6806K/85 neon pink	90292 5	6	85	920	6
Support QST	61493 4			1092	1

CATENA 6806K COLOR

NIVEAU DE SÉCURITÉ



CARACTÉRISTIQUES



Support QST



VARIANTES



blue mask



grey lightning



grey star

DONNÉES TECHNIQUES

- Chaîne à maillons carrés de 6 mm de diamètre recouverte d'un gainage en tissu pour protéger la peinture du vélo
- La chaîne et le boîtier sont fait en acier spécial cémenté

TECHNOLOGIE



Article	EAN 4003318	mm ↑	cm ←	Poids g	Unité emb.
6806K/85 cherry heart	90288 8	6	85	920	6
6806K/85 blue mask	90286 4	6	85	920	6
6806K/85 grey lightning	90287 1	6	85	920	6
6806K/85 grey star	90285 7	6	85	920	6
Support QST	61493 4			1092	1

CATENA 6806K REFLECTIVE

NIVEAU DE SÉCURITÉ



CARACTÉRISTIQUES



Support QST



Chaînes

DONNÉES TECHNIQUES

- Chaîne à maillons carrés de 6 mm de diamètre recouverte d'un gainage en tissu pour protéger la peinture du vélo
- La chaîne est en acier special cémenté
- La gaine est réfléchissante pour une meilleure visibilité

TECHNOLOGIE



LOGOS D'AGRÈMENT



Article	EAN 4003318	⌀ mm	----- cm	Poids g	Unité emb.
6806K/85 reflective	69104 1	6	85	920	6
6806K/110 reflective	69105 8	6	110	1160	6
Support QST	61493 4			1092	1

6806K CLASSIC

NIVEAU DE SÉCURITÉ



CARACTÉRISTIQUES



Support QST



DONNÉES TECHNIQUES



- Chaîne à maillons carrés de 6 mm de diamètre recouverte d'un gainage en tissu pour protéger la peinture du vélo
- La chaîne est en acier spécial cémenté

TECHNOLOGIE



LOGOS D'AGRÈMENT



Article	EAN 4003318	 mm	 cm	Poids g	Unité emb.
6806K/85 Classic	90057 0	6	85	920	6
6806K/110 Classic	90056 3	6	110	1160	6
Support QST	61493 4			1092	1

STEEL-O-CHAIN™ 5805K

NIVEAU DE SÉCURITÉ



CARACTÉRISTIQUES



VARIANTES



blue



red



lime



pink



Chaînes

DONNÉES TECHNIQUES

- Chaîne à maillons carrés de 5 mm avec une gaine en tissu pour protéger la peinture du vélo
- La chaîne est en acier spécial cimenté

TECHNOLOGIE



Article	EAN 4003318	 mm	 cm	Poids g	Unité emb.
5805K/75 black	71205 0	5	75	590	6
5805K/75 blue	72490 9	5	75	590	6
5805K/75 red	72489 3	5	75	590	6
5805K/75 lime	72491 6	5	75	590	6
5805K/75 pink	72492 3	5	75	590	6
5805K/110 black	72493 0	5	110	780	6

STEEL-O-CHAIN™ 5805C

NIVEAU DE SÉCURITÉ



VARIANTES



blue



red



lime



pink

DONNÉES TECHNIQUES

- Chaîne à maillons carrés de 5 mm avec une gaine en tissu pour protéger la peinture du vélo
- La chaîne est en acier special cémenté
- Les molettes à 2 composantes assurent une lisibilité permanente de numéros
- Programmation individuelle du code

TECHNOLOGIE



Article	EAN 4003318	mm	cm	Poids g	Unité emb.
5805C/75 black	71206 7	5	75	500	6
5805C/75 blue	72494 7	5	75	500	6
5805C/75 red	72495 4	5	75	500	6
5805C/75 lime	72496 1	5	75	500	6
5805C/75 pink	72497 8	5	75	500	6
5805C/110 black	72498 5	5	110	720	6

STEEL-O-CHAIN™ 4804K

NIVEAU DE SÉCURITÉ



CARACTÉRISTIQUES



VARIANTES



blue



red



lime



pink

Chaînes

DONNÉES TECHNIQUES

- Chaîne à maillons carrés de 4 mm avec une gaine en tissu pour protéger la peinture du vélo
- La chaîne est en acier spécial cimenté

TECHNOLOGIE



Article	EAN 4003318	mm	cm	Poids g	Unité emb.
4804K/75 black	72483 1	4	75	380	6
4804K/75 blue	72484 8	4	75	380	6
4804K/75 red	72485 5	4	75	380	6
4804K/75 lime	72486 2	4	75	380	6
4804K/75 pink	72487 9	4	75	380	6
4804K/110 black	72488 6	4	110	520	6

STEEL-O-CHAIN™ 4804C SYMBOLS



DONNÉES TECHNIQUES

- Chaîne à maillons carrés de 4 mm de diamètre recouverte d'un gainage en tissu pour protéger la peinture du vélo
- La chaîne est faite en acier spécial cimenté
- Utilisation ludique et facile pour les enfants grâce aux symboles au lieu des chiffres

TECHNOLOGIE



NIVEAU DE SÉCURITÉ VARIANTES



symbols blue



symbols pink



symbols red

Article

Article	EAN 4003318	mm	cm	Poids g	Unité emb.
4804C/75 blue SYMBOLS	86809 2	4	75	360	6
4804C/75 pink SYMBOLS	86810 8	4	75	360	6
4804C/75 red SYMBOLS	87499 4	4	75	360	6
4804C/75 lime SYMBOLS	87498 7	4	75	360	6

STEEL-O-CHAIN™ 4804C



DONNÉES TECHNIQUES

- Chaîne à maillons carrés de 4 mm avec une gaine en tissu pour protéger la peinture du vélo
- La chaîne est en acier special cimenté
- Programmation individuelle du code

TECHNOLOGIE



NIVEAU DE SÉCURITÉ VARIANTES



black



blue



red



lime



pink

Article

Article	EAN 4003318	mm	cm	Poids g	Unité emb.
4804C/75 black	71617 1	4	75	360	6
4804C/75 blue	71616 4	4	75	360	6
4804C/75 red	72468 8	4	75	360	6
4804C/75 lime	72480 0	4	75	360	6
4804C/75 pink	72481 7	4	75	360	6
4804C/110 black	72482 4	4	110	480	6

1500 WEB

CARACTÉRISTIQUES



DONNÉES TECHNIQUES

- Chaîne à maillons carrés de 4 mm avec une gaine en tissu pour protéger la peinture du vélo
- La chaîne est en acier special cémenté

TECHNOLOGIE



NIVEAU DE SÉCURITÉ VARIANTES



lime



orange



red



white



coral

Article

Article	EAN 4003318	mm	cm	Poids g	Unité emb.
1500/60 web black	56345 4	4	60	230	12
1500/60 web lime	56344 7	4	60	230	12
1500/60 web orange	56920 3	4	60	230	12
1500/60 web red	56343 0	4	60	230	12
1500/60 web white	56921 0	4	60	230	12
1500/60 web coral	57895 3	4	60	230	12
1500/60 web color (4x lime, orange, red)	57658 4	4	60	230	12
1500/110 web black	56346 1	4	110	360	12
1500/110 web color (4x lime, orange, red)	57659 1	4	110	360	12

1200 WEB

NIVEAU DE SÉCURITÉ VARIANTES



lime



orange



red



white



coral

Article

Article	EAN 4003318	mm	cm	Poids g	Unité emb.
1200/60 web black	56341 6	4	60	200	12
1200/60 web lime	56340 9	4	60	200	12
1200/60 web orange	56922 7	4	60	200	12
1200/60 web red	56339 3	4	60	200	12
1200/60 web white	56924 1	4	60	200	12
1200/60 web coral	57893 9	4	60	200	12
1200/60 web color (4x lime, orange, red)	57656 0	4	60	200	12
1200/110 web black	56342 3	4	110	330	12
1200/110 web color (4x lime, orange, red)	57657 7	4	110	330	12

DONNÉES TECHNIQUES

- Chaîne à maillons carrés de 4 mm avec une gaine en tissu pour protéger la peinture du vélo
- La chaîne est en acier special cémenté

ANTIVOLS GOOSE

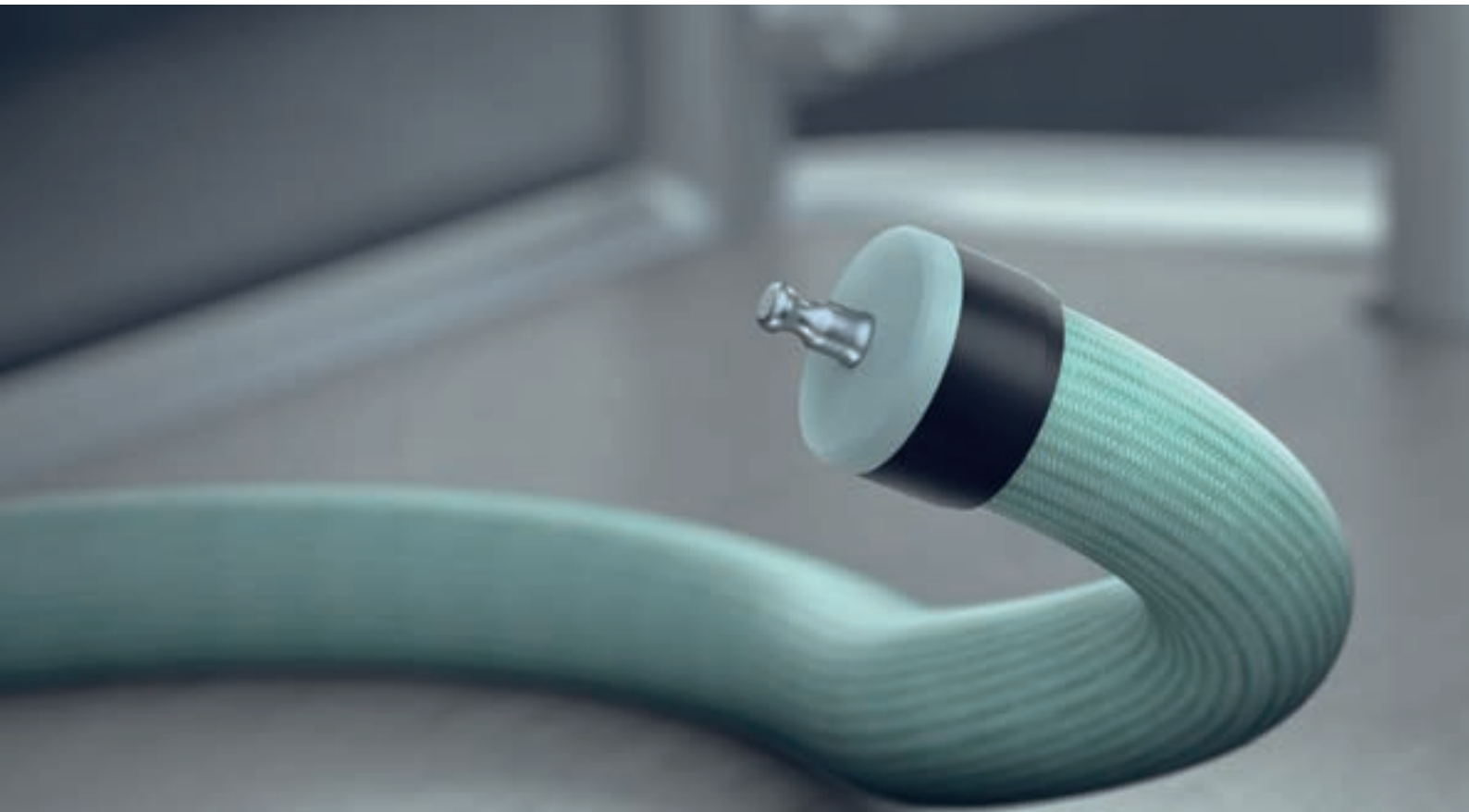

L O C K



6206K GOOSE LOCK



mint

Page 70



black

Page 700



rosemauve

Page 70



flint

Page 70

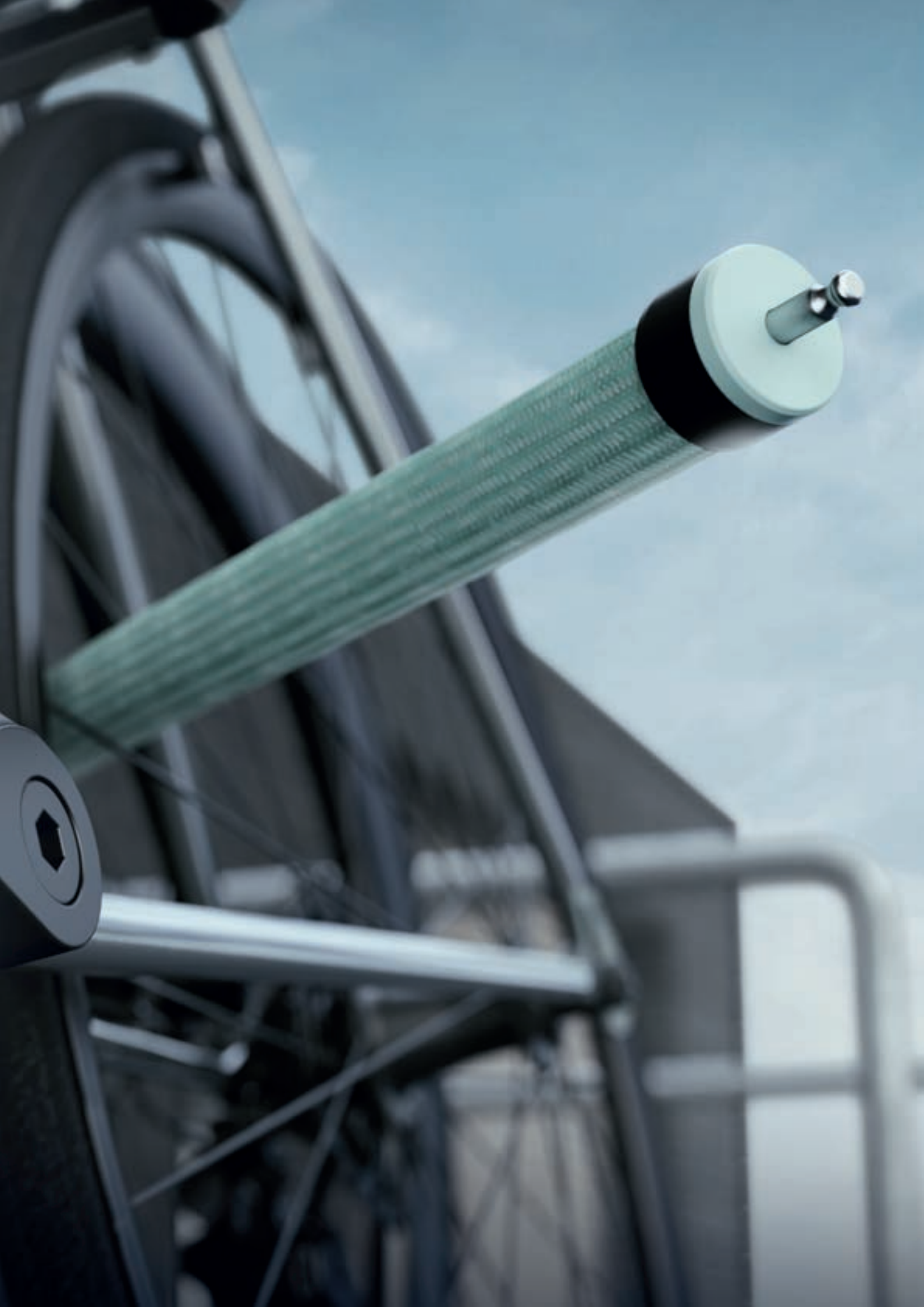

6206K GOOSE LOCK

NEW

NIVEAU DE SÉCURITÉ



VARIANTES



black



rosemauve



flint

Antivois Goose

DONNÉES TECHNIQUES

- Chaîne de 6 mm d'épaisseur recouverte d'un gainage en tissu pour protéger la peinture du vélo
- Chaîne à mémoire de forme
- La gaine offre une très grande protection contre l'abrasion et n'absorbe aucun liquide, comme par exemple l'eau ou l'huile
- La chaîne est en acier spécial cémenté
- Ne produit aucun son durant les déplacements à vélo

TECHNOLOGIE



Article	EAN 4003318	diamètre des maillons de la chaîne mm	Longueur de la chaîne cm	Poids g	Unité emb.
6206K/85 black	95546 4	6	85	920	2
6206K/110 black	95547 1	6	110	1120	2
6206K/110 rosemauve	96156 4	6	110	1120	2
6206K/110 mint	96158 8	6	110	1120	2
6206K/110 flint	96157 1	6	110	1120	2

STEEL-O-FLEX



STEEL-O-FLEX™

950



black

Page 74

IVEN STEEL-O-FLEX™

8200



black

Page 75

IVERA STEEL-O-FLEX™

7200



black

Page 76

CENTURO

860



black

Page 77

PHANTOM™

8960



black

Page 78

STEEL-O-FLEX™

RAYDO PRO 1460



black

Page 79

STEEL-O-FLEX™

TRESOR 1360



black

Page 80

MICROFLEX

6615K



black

Page 81

TRESORFLEX

6615C



black

Page 81

STEEL-O-FLEX™ 950

NIVEAU DE SÉCURITÉ



CARACTÉRISTIQUES

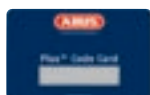

Plus



Support UGH 02





DONNÉES TECHNIQUES

- Des rotules en acier de 25 mm de diamètre protègent le câble en acier
- Revêtement synthétique pour protéger la peinture du vélo
- Les rotules, le boîtier et certaines pièces du mécanisme de fermeture sont en acier spécial cémenté
- Le cylindre ABUS Plus offre une protection très efficace contre toute tentative de manipulation, comme le crochetage
- Cache-entrée de clé manuelle pour protéger de la poussière et de la corrosion

LOGOS D'AGRÈMENT



Article	EAN 4003318	 mm	 cm	Poids g	Unité emb.
950/100	25715 5	25	100	1540	2
Support UGH 02	26624 9			80	1

IVEN STEEL-0-FLEX™ 8200

NIVEAU DE SÉCURITÉ



CARACTÉRISTIQUES



Support UGH 02



DONNÉES TECHNIQUES



- Des rotules en acier de 25 mm de diamètre protègent le câble en acier
- Les rotules, le boîtier et certaines pièces du mécanisme de fermeture sont en acier spécial cémenté
- Forme ergonomique du boîtier recouvert de la technologie Softcase offrant une meilleure résistance à l'impact

TECHNOLOGIE



LOGOS D'AGRÈMENT



Article	EAN 4003318	 mm	 cm	Poids g	Unité emb.
8200/85	55148 2	25	85	1340	6
8200/110	55149 9	25	110	1580	2
Support UGH 02	26624 9			80	1

IVERA STEEL- O- FLEX™ 7200

NIVEAU DE SÉCURITÉ



CARACTÉRISTIQUES



Support IVERA RBU



DONNÉES TECHNIQUES



- Des rotules en acier de 22 mm de diamètre protègent le câble en acier
- Recouvert d'une gaine en fibre synthétique (type cote de mailles) très solide pour une bonne protection du vélo
- Les rotules, le boîtier et certaines pièces du mécanisme de fermeture sont en acier spécial cémenté

TECHNOLOGIE



LOGOS D'AGRÈMENT



Article	EAN 4003318	 mm	 cm	Poids g	Unité emb.
7200/85	55137 6	22	85	700	6
7200/85 + RBU	55139 0	22	85	840	6
7200/110	55138 3	22	110	860	6
7200/110 + RBU	55140 6	22	110	1000	6
Support RBU IVERA	58497 8			125	1

CENTURO 860

NIVEAU DE SÉCURITÉ



CARACTÉRISTIQUES



QuickSnap RBU



DONNÉES TECHNIQUES



- Des rotules en acier de 20 mm de diamètre protègent le câble en acier
- Revêtement synthétique pour protéger la peinture du vélo
- Les rotules, le boîtier et certaines pièces du mécanisme de fermeture sont en acier spécial cémenté

TECHNOLOGIE



LOGOS D'AGRÈMENT



Article	EAN 4003318	 mm	 cm	Poids g	Unité emb.
860/85	31495 7	20	85	780	6
860/85 QS RBU	31493 3	20	85	825	6
860/110	31496 4	20	110	980	6
860/110 QS RBU	31494 0	20	110	1025	6
RBU QuickSnap	31487 2			40	6

PHANTOM™ 8960

NIVEAU DE SÉCURITÉ



CARACTÉRISTIQUES



TexFL



KF



DONNÉES TECHNIQUES



- Des rotules en acier de 17 mm de diamètre protègent le câble en acier
- Revêtement synthétique pour protéger la peinture du vélo
- Les rotules, le boîtier et certaines pièces du mécanisme de fermeture sont en acier spécial cémenté
- Cylindre ABUS Extra Class avec une clé réversible

TECHNOLOGIE



LOGOS D'AGRÈMENT



Article	EAN 4003318	 mm	 cm	Poids g	Unité emb.
8960/85 KF	78595 5	17	85	700	6
8960/85 TexFL	39680 9	17	85	720	6
8960/110 TexFL	39683 0	17	110	920	6
KF	12433 4			42	6
TexFL	39730 1			77	1

STEEL-0-FLEX™ RAYDO PRO 1460

NIVEAU DE SÉCURITÉ



CARACTÉRISTIQUES



Combo Licht



TexKF



KF



DONNÉES TECHNIQUES



- Des rotules en acier de 20 mm de diamètre protègent le câble en acier
- Revêtement synthétique pour protéger la peinture du vélo
- Les rotules, le boîtier et certaines pièces du mécanisme de fermeture sont en acier spécial cémenté
- Programmation individuelle du code
- Fonction Press'n Shine: des molettes lumineuses pour faciliter l'ouverture de l'antivol même dans l'obscurité

TECHNOLOGIE



LOGOS D'AGRÈMENT



Article	EAN 4003318	 mm	 cm	Poids g	Unité emb.
1460/85 KF	59216 4	20	85	780	6
1460/85 TexKF	59217 1	20	85	780	6
KF	12433 4			42	6
TexKF Mini	23265 7			70	1

STEEL- O- FLEX™ TRESOR 1360

NIVEAU DE SÉCURITÉ



DONNÉES TECHNIQUES



- Des rotules en acier de 20 mm de diamètre protègent le câble en acier
- Revêtement synthétique pour protéger la peinture du vélo
- Bonne finition des molettes garantissant une très bonne visibilité des chiffres à long terme
- Protection spéciale contre toute tentative de manipulation non autorisée du code
- Equipé de touches réfléchissantes pour faciliter l'entrée du code dans l'obscurité
- Programmation individuelle du code

TECHNOLOGIE



LOGOS D'AGRÈMENT



Article	EAN 4003318	 mm	 cm	Poids g	Unité emb.
1360/85 black	42935 4	20	85	680	6
1360/110 black	42934 7	20	110	880	6

MICROFLEX 6615K

CARACTÉRISTIQUES



SCMU



SCLL

NIVEAU DE SÉCURITÉ



DONNÉES TECHNIQUES

- Des rotules en acier de 15 mm de diamètre protègent le câble en acier
- Revêtement synthétique pour protéger la peinture du vélo

TECHNOLOGIE



Article	EAN 4003318	mm	cm	Poids g	Unité emb.
6615K/85/15 black	13410 4	15	85	540	6
6615K/85/15 black SCMU	13408 1	15	85	580	6
6615K/85/15 black SCLL	86174 1	15	85	580	6
6615K/120/15 black	13412 8	15	120	700	6
6615K/120/15 black SCMU	13409 8	15	120	760	6
6615K/120/15 black SCLL	86172 7	15	120	760	6
SCLL 6K	87984 5			47	12
Snap Cage MU 6K	20079 3			40	12

TRESORFLEX 6615C

CARACTÉRISTIQUES



SCMU

SCLL



DONNÉES TECHNIQUES

- Des rotules en acier de 15 mm de diamètre protègent le câble en acier
- Revêtement synthétique pour protéger la peinture du vélo
- Bonne finition des molettes garantissant une très bonne visibilité des chiffres à long terme
- Protection spéciale contre toute tentative de manipulation non autorisée du code
- Equipé de touches réfléchissantes pour faciliter l'entrée du code dans l'obscurité
- Programmation individuelle du code

NIVEAU DE SÉCURITÉ



TECHNOLOGIE



Article	EAN 4003318	mm	cm	Poids g	Unité emb.
6615C/85/15 black	13659 7	15	85	560	6
6615C/85/15 black SCMU	13657 3	15	85	705	6
6615C/85/15 black SCLL	86173 4	15	85	705	6
6615C/120/15 black	13780 8	15	120	720	6
6615C/120/15 black SCMU	13658 0	15	120	780	6
6615C/120/15 black SCLL	86171 0	15	120	780	6
SCLL 6C	87983 8			47	12
Snap Cage MU 6C	20113 4			40	12

ANTIVOLS CÂBLE EN SPIRALE



PHANTOM™

8950



black

Page 86

RAYDO PRO

1450



black

Page 87

BOOSTER

6512K



black

Page 88

TRESOR

6512C



black

Page 88

PRIMO

5510K



black

Page 89

NUMERO

5510C



black

Page 89

STAR

4508K



black

Page 90



blue

Page 90



red

Page 90



green

Page 90

STAR

4508C



black

Page 90



blue

Page 90



red

Page 90



green

Page 90

3506K



black

Page 91



blue

Page 91



orange

Page 91



red

Page 91



green

Page 91



pink

Page 91



silver

Page 91

Antivols câble
en spirale



black

Page 91



blue

Page 91



orange

Page 91



red

Page 91



green

Page 91



pink

Page 91

3506C



silver

Page 91



black

Page 92

IVERA CABLE

7220



black

Page 94

RACER

6412K



black

Page 94

TRESOR

6412C



black

Page 95

PRIMO

5410K



black

Page 95

NUMERINO

5410C



black

Page 96

4408K



blue

Page 96



red

Page 96



green

Page 96



black

Page 96

4408C



blue

Page 96



red

Page 96



green

Page 96

3406K



black

Page 97



blue

Page 97



orange

Page 97



red

Page 97



green

Page 97



pink

Page 97



silver

Page 97

3406C



black

Page 97



blue

Page 97



orange

Page 97



red

Page 97



green

Page 97



pink

Page 97



silver

Page 97

PHANTOM™ 8950

NIVEAU DE SÉCURITÉ



CARACTÉRISTIQUES



KF



TexKF



TexFL





DONNÉES TECHNIQUES

- Câble à spirale de 12 ou de 15 mm de diamètre, très robuste, de bonne qualité et très flexible
- Revêtement synthétique, look noir mat pour protéger la peinture du vélo
- Cylindre ABUS Extra-Classe équipé d'une clé réversible encodée

TECHNOLOGIE



Article	EAN 4003318	 mm	 cm	Poids g	Unité emb.
8950/180 KF	39685 4	12	180	645	6
8950/180 TexKF	39684 7	12	180	655	6
8950/180 TexFL	39802 5	12	180	665	6

RAYDO PRO 1450

NIVEAU DE SÉCURITÉ



CARACTÉRISTIQUES



Combo Licht



TexKF



DONNÉES TECHNIQUES

- Câble à spirale de 12 mm de diamètre, de bonne qualité et très flexible
- Revêtement synthétique, pour protéger la peinture du vélo
- Programmation individuelle du code
- Fonction Press'n Shine: des molettes lumineuses pour faciliter l'ouverture de l'antivol même dans l'obscurité

TECHNOLOGIE



Article

1450/185 black TexKF

EAN
4003318

59214 0

mm

12

cm

185

Poids
g

718

Unité
emb.

6

BOOSTER 6512K

CARACTÉRISTIQUES



SCMU

SCLL

SR

NIVEAU DE SÉCURITÉ





DONNÉES TECHNIQUES

- Câble à spirale de 12 mm de diamètre, très robuste, de bonne qualité et très flexible
- Revêtement synthétique, pour protéger la peinture du vélo

TECHNOLOGIE



Article	EAN 4003318	 mm	 cm	Poids g	Unité emb.
6512K/180 black	13400 5	12	180	531	6
6512K/180 black SCMU	13399 2	12	180	573	6
6512K/180 black SCLL	86170 3	12	180	573	6
6512K/180 black SR	61470 5	12	180	573	6

TRESOR 6512C

CARACTÉRISTIQUES



SCMU

SCLL

SR

NIVEAU DE SÉCURITÉ





DONNÉES TECHNIQUES

- Câble à spirale de 12 mm de diamètre, très robuste, de bonne qualité et très flexible
- Revêtement synthétique, pour protéger la peinture du vélo
- Bonne finition des molettes garantissant une très bonne visibilité des chiffres à long terme
- Programmation individuelle du code

TECHNOLOGIE



Article	EAN 4003318	 mm	 cm	Poids g	Unité emb.
6512C/180 black	13415 9	12	180	549	6
6512C/180 black SCMU	13414 2	12	180	600	6
6512C/180 black SCLL	86169 7	12	180	600	6
6512C/180 black SR	61471 2	12	180	600	6

PRIMO 5510K

CARACTÉRISTIQUES



SCMU

SCLL

NIVEAU DE SÉCURITÉ



DONNÉES TECHNIQUES

- Câble à spirale de 10 mm de diamètre, de bonne qualité et très flexible
- Revêtement synthétique, pour protéger la peinture du vélo

TECHNOLOGIE



Article	EAN 4003318	mm	cm	Poids g	Unité emb.
5510K/180 black	14260 4	10	180	460	6
5510K/180 black SCMU	14245 1	10	180	508	6
5510K/180 black SCLL	86168 0	10	180	508	6

NUMERO 5510C

CARACTÉRISTIQUES



SCMU

SCLL



DONNÉES TECHNIQUES

- Câble à spirale de 10 mm de diamètre, de bonne qualité et très flexible
- Revêtement synthétique, pour protéger la peinture du vélo
- La fonction Dark-touch facilite l'usage dans le noir, grâce à son impression spéciale
- Bonne finition des molettes garantissant une très bonne visibilité des chiffres à long terme
- Programmation individuelle du code

TECHNOLOGIE



Article	EAN 4003318	mm	cm	Poids g	Unité emb.
5510C/180 black	16524 5	10	180	459	6
5510C/180 black SCMU	16523 8	10	180	508	6
5510C/180 black SCLL	86167 3	10	180	571	6

STAR 4508K

CARACTÉRISTIQUES



DONNÉES TECHNIQUES

- Câble à spirale de 8 mm de diamètre, de bonne qualité et très flexible
- Revêtement synthétique, pour protéger la peinture du vélo

TECHNOLOGIE



NIVEAU DE SÉCURITÉ VARIANTES



blue



red



green

Article

Article	EAN 4003318	mm	cm	Poids g	Unité emb.
4508K/150 black	20016 8	8	150	280	12
4508K/150 blue	40775 8	8	150	280	12
4508K/150 red	40776 5	8	150	280	12
4508K/150 green	40777 2	8	150	280	12

STAR 4508C

NIVEAU DE SÉCURITÉ VARIANTES



blue



red



green

Article

Article	EAN 4003318	mm	cm	Poids g	Unité emb.
4508C/150 black	20019 9	8	150	260	12
4508C/150 blue	40778 9	8	150	260	12
4508C/150 red	40779 6	8	150	260	12
4508C/150 green	40780 2	8	150	260	12

DONNÉES TECHNIQUES

- Câble en acier de 8 mm de diamètre, de bonne qualité et très flexible
- Revêtement synthétique, pour protéger la peinture du vélo
- La fonction Dark-touch facilite l'usage dans le noir, grâce à son impression spéciale
- Programmation individuelle du code
- Bonne finition des molettes garantissant une très bonne visibilité des chiffres à long terme

TECHNOLOGIE



3506K

CARACTÉRISTIQUES



DONNÉES TECHNIQUES

- Câble spiralé de 6 mm d'épaisseur et super flexible
- Revêtement plastique pour éviter d'endommager la peinture du vélo

NIVEAU DE SÉCURITÉ VARIANTES



blue



orange



red



green



pink



silver

Article

	EAN 4003318	mm	cm	Poids g	Unité emb.
3506K/120 black	40769 7	6	120	206	12
3506K/120 Color	40770 3	6	120	206	12
3506K/180 black	40771 0	6	180	206	12

3506C



DONNÉES TECHNIQUES

- Câble spiralé de 6 mm d'épaisseur et super flexible
- Revêtement plastique pour éviter d'endommager la peinture du vélo

NIVEAU DE SÉCURITÉ VARIANTES



blue



orange



red



green



pink



silver

Article

	EAN 4003318	mm	cm	Poids g	Unité emb.
3506C/120 black	40772 7	6	120	174	12
3506C/120 Color	40773 4	6	120	174	12
3506C/180 black	40774 1	6	180	174	12

IUNITÉ EMB.RA CABLE 7220

NIVEAU DE SÉCURITÉ



CARACTÉRISTIQUES



IUnité emb.RA RBU



DONNÉES TECHNIQUES



- Câble en acier de 20 mm de diamètre de haute qualité
- Recouvert d'une gaine en mailles synthétiques très solide pour une bonne protection de la peinture du vélo
- Le boîtier et certains éléments de fermeture sont en acier cémenté

TECHNOLOGIE



TESTSIEGEL



Article	EAN 4003318	 mm	 cm	Poids g	Unité emb.
7220/85 black	55145 1	20	85	660	6
Support IVERA RBU	58497 8			125	1



RACER 6412K

CARACTÉRISTIQUES



NIVEAU DE SÉCURITÉ VARIANTES





DONNÉES TECHNIQUES

- Câble en acier de 12 mm d'épaisseur
- Revêtement plastique pour éviter d'endommager la peinture du vélo

TECHNOLOGIE



Article	EAN 4003318	 mm	 cm	Poids g	Unité emb.
6412K/85 black	40804 5	12	85	386	6
6412K/85 black SCMU	40805 2	12	85	387	6
6412K/85 black SCLL	40806 9	12	85	419	6
6412K/85 black SR	61476 7	12	85	387	6
6412K/120 black	63491 8	12	120	492	6
6412K/120 black SCMU	63492 5	12	120	535	6
6412K/120 black SCLL	63529 8	12	120	535	6
6412K/120 black SR	63530 4	12	120	535	6

TRESOR 6412C

CARACTÉRISTIQUES



NIVEAU DE SÉCURITÉ VARIANTES





DONNÉES TECHNIQUES

- Câble en acier de 12 mm d'épaisseur
- Revêtement plastique pour éviter d'endommager la peinture du vélo
- Des chiffres moulés à deux composants garantissent une visibilité tout au long de la vie
- Code configurable individuellement

TECHNOLOGIE



Article	EAN 4003318	 mm	 cm	Poids g	Unité emb.
6412C/85 black	40807 6	12	85	396	6
6412C/85 black SCMU	40808 3	12	85	441	6
6412C/85 black SCLL	40809 0	12	85	419	6
6412C/85 black SR	61477 4	12	85	441	6
6412C/120 black	63489 5	12	120	503	6
6412C/120 black SCMU	63490 1	12	120	560	6
6412C/120 black SCLL	63527 4	12	120	560	6
6412C/120 black SR	63528 1	12	120	560	6

PRIMO 5410K

CARACTÉRISTIQUES



NIVEAU DE SÉCURITÉ





DONNÉES TECHNIQUES

- Câble en acier de 10 mm d'épaisseur
- Revêtement plastique pour éviter d'endommager la peinture du vélo

TECHNOLOGIE



Article	EAN 4003318	 mm	 cm	Poids g	Unité emb.
5410K/85 black	40798 7	10	85	278	6
5410K/85 black SCMU	40799 4	10	85	330	6
5410K/85 black SCLL	40800 7	10	85	334	6
5410K/85 black SR	61474 3	10	85	324	6

NUMERINO 5410C

CARACTÉRISTIQUES



NIVEAU DE SÉCURITÉ





DONNÉES TECHNIQUES

- Câble en acier de 10 mm d'épaisseur
- Revêtement plastique pour éviter d'endommager la peinture du vélo
- Les molettes à 2 composantes assurent une lisibilité permanente de numéros
- Code configurable individuellement

TECHNOLOGIE



Article	EAN 4003318	 mm	 cm	Poids g	Unité emb.
5410C/85 black	40801 4	10	85	276	6
5410C/85 black SCMU	40802 1	10	85	330	6
5410C/85 black SCLL	40803 8	10	85	334	6
5410C/85 black SR	61475 0	10	85	320	6

4408K

CARACTÉRISTIQUES



DONNÉES TECHNIQUES

- Câble en acier de 8 mm d'épaisseur
- Revêtement plastique pour éviter d'endommager la peinture à vélo

NIVEAU DE SÉCURITÉ VARIANTES



blue



red



green

Article	EAN 4003318	mm	cm	Poids g	Unité emb.
4408K/65 black	40790 1	8	65	271	12
4408K/65 blue	40791 8	8	65	271	12
4408K/65 red	40792 5	8	65	271	12
4408K/65 green	40793 2	8	65	271	12

4408C

DONNÉES TECHNIQUES

- Câble en acier de 8 mm d'épaisseur
- Revêtement plastique pour éviter d'endommager la peinture du vélo



TECHNOLOGIE



NIVEAU DE SÉCURITÉ VARIANTES



blue



red



green

Article	EAN 4003318	mm	cm	Poids g	Unité emb.
4408C/65 black	40794 9	8	65	271	12
4408C/65 blue	40795 6	8	65	271	12
4408C/65 red	40796 3	8	65	271	12
4408C/65 green	40797 0	8	65	271	12

3406K

CARACTÉRISTIQUES



DONNÉES TECHNIQUES

- Câble en acier de 6 mm d'épaisseur
- Revêtement plastique pour éviter d'endommager la peinture du vélo

NIVEAU DE SÉCURITÉ VARIANTES



blue



orange



red



green



pink



silver

Article

Article	EAN 4003318	mm	cm	Poids g	Unité emb.
3406K/55 black	40782 6	6	55	139	12
3406K/55 Color	40785 7	6	55	139	12

3406C

DONNÉES TECHNIQUES

- Câble en acier de 6 mm d'épaisseur
- Revêtement plastique pour éviter d'endommager la peinture du vélo
- Code configurable individuellement



NIVEAU DE SÉCURITÉ VARIANTES



blue



orange



red



green



pink



silver

Article

Article	EAN 4003318	mm	cm	Poids g	Unité emb.
3406C/55 black	40787 1	6	55	114	12
3406C/55 Color	40789 5	6	55	114	12

ANTIVOLS DE CADRE ET SERRURES DE BATTERIE



PRO SHIELD XPLUS™
5955



black

Page 102

SHIELD XPLUS™
5755L



black

Page 103

PRO AMPARO
4750X / XL



black

Page 104

PRO AMPARO
4750S / SL



black

Page 105

4650X / XL



black

Page 106

4650S / SL



black

Page 107

PRO TECTIC™
4960



black

Page 108

TECTIC™
496



black

Page 109

ACH 2.0
ADAPTOR CHAIN



black

Page 110

ADAPTOR
CABLE



black

Page 110

IVYTEX
ADAPTOR CHAIN



black

Page 111



crossing grey

Page 111



sparkling orange

Page 111

ANTIVOL DE CADRE

Nous aimerions vous aider à trouver encore plus rapidement à l'avenir le bon antivol de cadre pour le vélo de votre client. Le dimensionnement ci-dessous est destiné à vous aider dans ce processus.

Vous pouvez également demander à votre commercial ABUS un outil vous permettant de prendre les mesures (numéro d'article : 90342). Le gabarit est conçu pour que vous puissiez le placer au bon endroit sur le pneu et lire directement quel est le bon antivol.

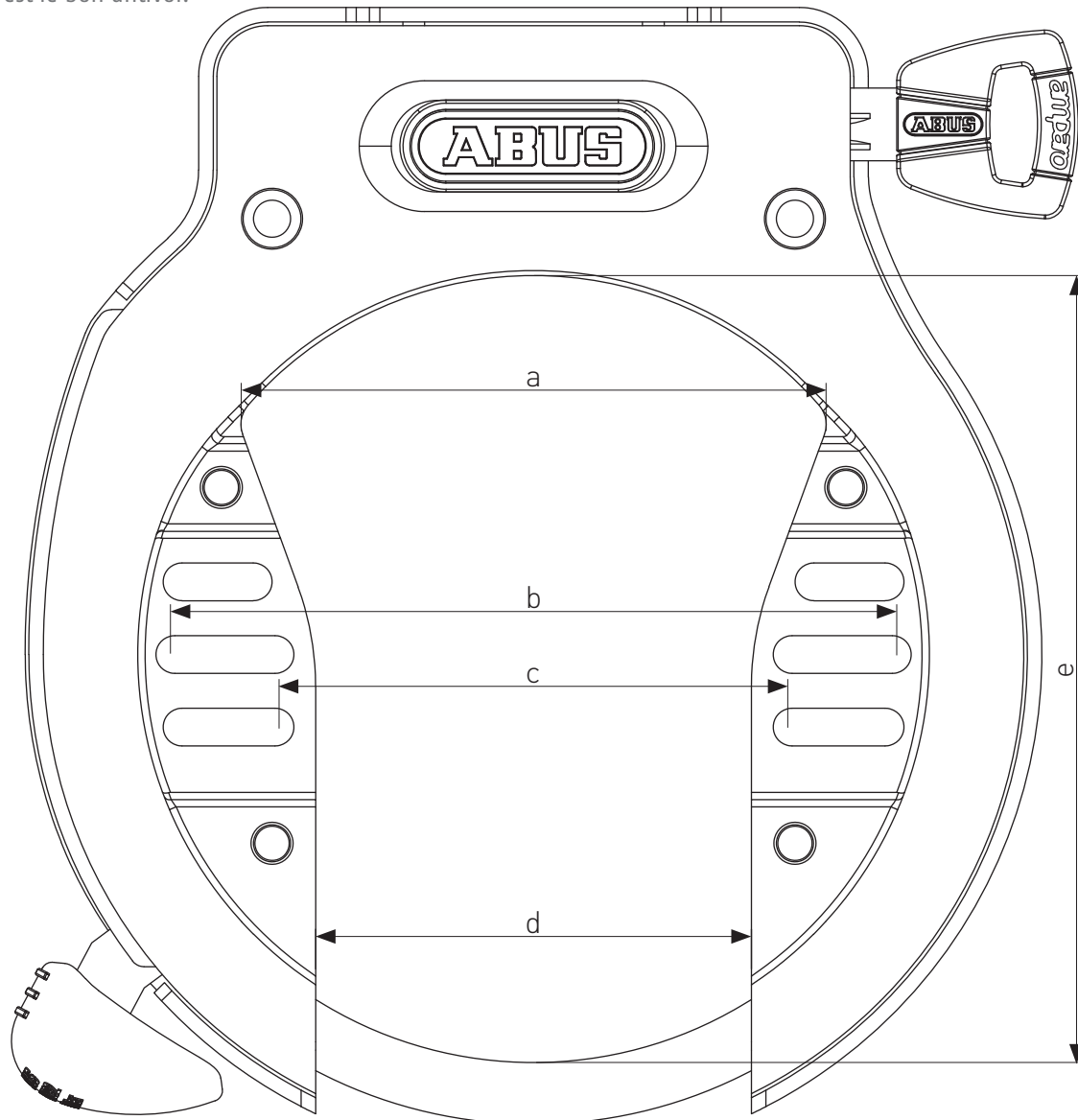

- a Largeur maximale du garde-boue
- b Espacement maximal des trous pour les points de fixation arrière
- c Espacement minimal des trous pour les points de fixation arrière
- d Largeur maximale du pneu
- e Hauteurs maximales de dégagement (haut du garde-boue par rapport à la jante)

Vous trouverez un aperçu de toutes les dimensions à la page suivante. En outre, vous trouverez également toutes les dimensions pertinentes sur chaque page produit dans les tableaux.

Article	EAN	a	b	c	d	e	Poids	Unité emb.	PRIX / PCE. €
	4003318	mm	mm	mm	mm	mm	g		

TOUTES LES TAILLES D'ANTIVOL DE CADRE DANS L'APERÇU

5955

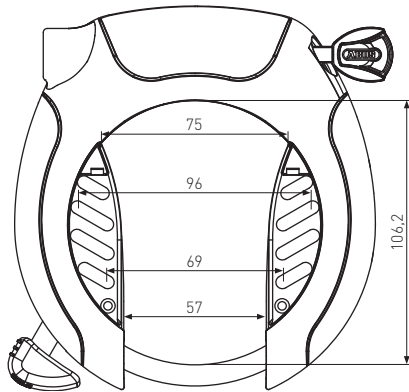

5755L

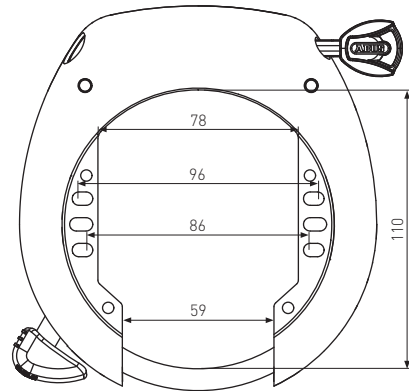

4750X / 4750XL

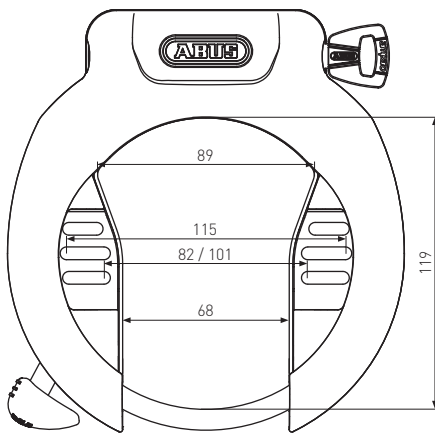

4750S / 4750SL

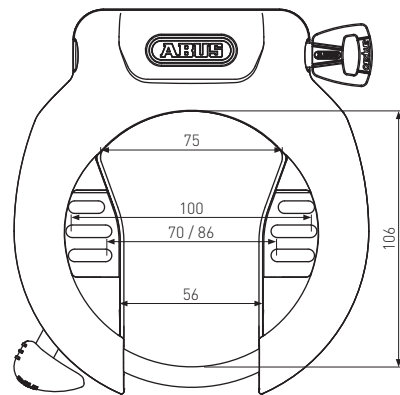

4650X / 4650XL

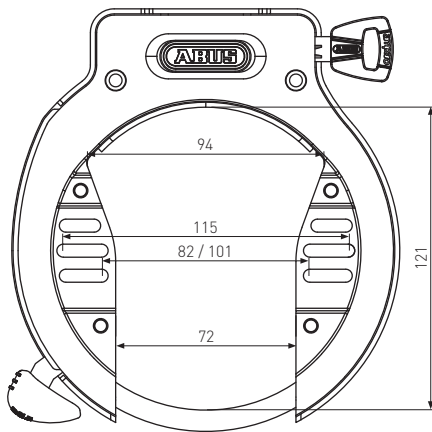

4650S / 4650SL

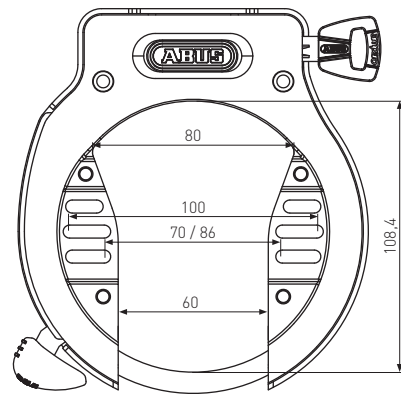

4960

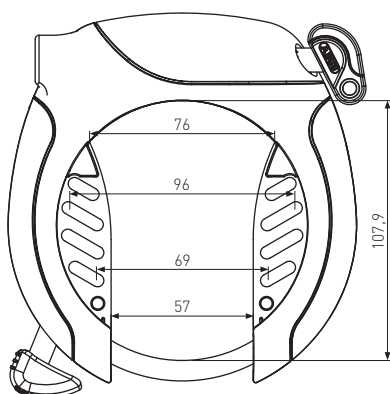

496

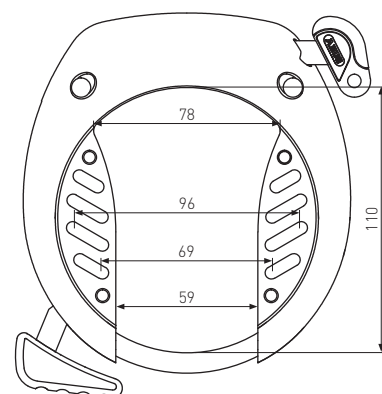

Antivolos de cadre et serrures de batterie

Toutes les dimensions sont en mm.

PRO SHIELD XPLUS™ 5955

NIVEAU DE SÉCURITÉ



CARACTÉRISTIQUES



VARIANTES



5955 + 6KS/85 + ST 5950

DONNÉES TECHNIQUES

- Anse de verrouillage de 8,5 mm d'épaisseur
- L'anse, le boîtier et les pièces de support de l'élément de fermeture sont fabriqués en acier spécialement cémenté
- Système de verrouillage pour une connexion facile des accessoires dans la housse d'antivol
- Cylindre ABUS XPlus pour une protection extrêmement élevée contre le vol, comme le crochetage
- Avec la version R, la clé reste dans le cylindre lorsque l'antivol est ouvert, avec la version NR, elle peut être retirée

TECHNOLOGIE



LOGOS D'AGRÈMENT



1) 37469 2) seulement valable pour les versions "R"

Article	EAN 4003318	a mm	b mm	c mm	d mm	e mm	Poids g	Unité emb.
5955 NR black	69082 2	75	96	69	57	106,2	660	6
5955 NR OE black	69084 6	75	96	69	57	106,2	660	15
5955 R black	69083 9	75	96	69	57	106,2	660	6
5955 R OE black	69085 3	75	96	69	57	106,2	660	15
5955 NR black + 6KS/85 + ST 5950	69086 0	75	96	69	57	106,2	1500	1
5955 NR black + 6KS/100 + ST 5950	69087 7	75	96	69	57	106,2	1600	1
SH485/495	37552 1						56	6
Bandes de serrage LH	56240 2						48	1

SHIELD XPLUS™ 5755L

NIVEAU DE SÉCURITÉ



CARACTÉRISTIQUES



DONNÉES TECHNIQUES

- Anse en acier de 8,5 mm de diamètre
- L'anse, le boîtier et certains éléments de fermeture sont en acier spécial cimenté
- Équipé d'un système de fermeture pour attacher facilement les accessoires au corps de l'antivol
- Le cylindre ABUS XPlus offre une protection très efficace contre toute tentative de manipulation, comme le crochétage
- Dans la version R (clé prisonnière), la clé reste dans le cylindre lorsque l'antivol est ouvert; dans la version NR (clé non prisonnière) la clé s'enlève même lorsque l'antivol est ouvert

TECHNOLOGIE



LOGOS D'AGRÈMENT



19 37469

Article	EAN 4003318	a mm	b mm	c mm	d mm	e mm	Poids g	Unité emb.
5755L NR black OE	69088 4	78	96	86	59	110	570	6
5755L R black OE	69089 1	78	96	86	59	110	570	6
5755L NR black OE gl. OneKey	91145 3	78	96	86	59	110	570	6
5755L R black OE gl. OneKey	91146 0	78	96	86	59	110	570	6
SH485/495	37552 1						56	6
Bandes de serrage LH	56240 2						48	1

PRO AMPARO 4750 X / XL

NIVEAU DE SÉCURITÉ



CARACTÉRISTIQUES



SH



Bandes de serrage LH



VARIANTES



4750 XL

DONNÉES TECHNIQUES

- Anse en acier de 8,5 mm de diamètre
- L'anse, le boîtier et certains éléments de fermeture sont en acier spécial cémenté
- Très grande ouverture pour des pneus extra larges
- Équipé d'un système de fermeture pour attacher facilement les accessoires au corps de l'antivol
- Dans la version R (clé prisonnière), la clé reste dans le cylindre lorsque l'antivol est ouvert; dans la version NR (clé non prisonnière) la clé s'enlève même lorsque l'antivol est ouvert

TECHNOLOGIE



LOGOS D'AGRÈMENT



1) 35482 2) seulement valable pour les versions "R".

Article	EAN 4003318	a mm	b mm	c mm	d mm	e mm	Poids g	Unité emb.
4750X NR black PRO AMPARO	69349 6	89	115	82	68	119	860	12
4750X NR black OE	86734 7	89	115	82	68	119	860	12
4750X R black PRO AMPARO	69352 6	89	115	82	68	119	860	12
4750X R black OE	86735 4	89	115	82	68	119	860	12
4750XL NR black PRO AMPARO	69353 3	89	115	101	68	119	800	12
4750XL NR black OE	86736 1	89	115	101	68	119	800	12
4750XL R black PRO AMPARO	69354 0	89	115	101	68	119	800	12
4750XL R black OE	86737 8	89	115	101	68	119	800	12
SH485/495	37552 1						56	6
Bandes de serrage LH	56240 2						48	1

PRO AMPARO 4750 S / SL

NIVEAU DE SÉCURITÉ



CARACTÉRISTIQUES



SH



Bandes de serrage LH



VARIANTES



4750 SL

DONNÉES TECHNIQUES

- Anse de verrouillage de 8,5 mm d'épaisseur
- L'anse, le boîtier et les pièces de support de l'élément de fermeture sont fabriqués en acier spécialement cémenté
- Système de verrouillage pour une connexion facile des accessoires dans la housse d'antivol
- Avec la version R, la clé reste dans le cylindre lorsque l'antivol est ouvert, avec la version NR, elle peut être retirée

TECHNOLOGIE



LOGOS D'AGRÈMENT



1) 34358 2) seulement valable pour les versions "R".

Article	EAN 4003318	a mm	b mm	c mm	d mm	e mm	Poids g	Unité emb.
4750S NR black PRO AMPARO	89676 7	75	100	70	56	106	652	12
4750S NR black OE	82611 5	75	100	70	56	106	700	12
4750S R black PRO AMPARO	89677 4	75	100	70	56	106	700	12
4750S R black OE	82612 2	75	100	70	56	106	760	12
4750SL NR black PRO AMPARO	89678 1	75	100	86	56	106	740	12
4750SL NR black OE	83573 5	75	100	86	56	106	740	12
4750SL R black PRO AMPARO	89679 8	75	100	86	56	106	740	12
4750SL R black OE	83574 2	75	100	86	56	106	740	12
SH485/495	37552 1						56	6
Bandes de serrage LH	56240 2						48	1

4650X / XL

NIVEAU DE SÉCURITÉ



CARACTÉRISTIQUES



SH



Bandes de serrage LH



VARIANTES



4650 XL

DONNÉES TECHNIQUES

- Anse en acier de 8,5 mm de diamètre
- L'anse, le boîtier et certains éléments de fermeture sont en acier spécial cémenté
- Très grande ouverture pour des pneus extra larges
- Équipé d'un système de fermeture pour attacher facilement les accessoires au corps de l'antivol
- Dans la version R (clé prisonnière), la clé reste dans le cylindre lorsque l'antivol est ouvert; dans la version NR (clé non prisonnière) la clé s'enlève même lorsque l'antivol est ouvert

TECHNOLOGIE



LOGOS D'AGRÈMENT



1) 34582 2) seulement valable pour les versions "R".

Article	EAN 4003318	a mm	b mm	c mm	d mm	e mm	Poids g	Unité emb.
4650X NR black OE	86730 9	94	115	82	72	121	720	12
4650X R black OE	86731 6	94	115	82	72	121	720	12
4650XL NR black OE	86732 3	94	115	101	72	121	720	12
4650XL R black OE	86733 0	94	115	101	72	121	720	12
SH485/495	37552 1						56	6
Bandes de serrage LH	56240 2						48	1

4650S / SL

NIVEAU DE SÉCURITÉ



CARACTÉRISTIQUES



SH



Bandes de serrage LH



VARIANTES



4650 SL

DONNÉES TECHNIQUES

- Anse de verrouillage de 8,5 mm d'épaisseur
- L'anse, le boîtier et les pièces de support de l'élément de fermeture sont fabriqués en acier spécialement cémenté
- Système de verrouillage pour une connexion facile des accessoires dans la housse d'antivol
- Avec la version R, la clé reste dans le cylindre lorsque l'antivol est ouvert, avec la version NR, elle peut être retirée

TECHNOLOGIE



LOGOS D'AGRÈMENT



1) 34358 2) seulement valable pour les versions "R".

Article	EAN 4003318	a mm	b mm	c mm	d mm	e mm	Poids g	Unité emb.
4650S NR black OE	82609 2	80	100	70	60	108,4	660	20
4650S R black OE	82610 8	80	100	70	60	108,4	660	20
4650SL NR black OE	83575 9	80	100	86	60	108,4	640	20
4650SL R black OE	83576 6	80	100	86	60	108,4	640	20
SH485/495	37552 1						56	6
Bandes de serrage LH	56240 2						48	1

PRO TECTIC™ 4960

NIVEAU DE SÉCURITÉ



CARACTÉRISTIQUES



SH



Bandes de serrage LH



VARIANTES



4960 + 6KS/85 + ST5850

DONNÉES TECHNIQUES

- Anse en acier cémenté de 8,5 mm de diamètre
- L'anse, le boîtier et certains éléments de fermeture sont en acier spécial cémenté
- Equipé d'un système de fermeture pour attacher facilement les accessoires au corps de l'antivol

TECHNOLOGIE



Article	EAN 4003318	a mm	b mm	c mm	d mm	e mm	Poids g	Unité emb.
4960 NR black	11260 7	76	96	69	57	107,9	520	6
4960 NR black OE	11270 6	76	96	69	57	107,9	520	18
4960 NR black + 6KS/85 & ST5850	11263 8	76	96	69	57	107,9	1346	3
SH485/495	37552 1						56	6
Bandes de serrage LH	56240 2						48	1

TECTIC™ 496

NIVEAU DE SÉCURITÉ



CARACTÉRISTIQUES



SH



Bandes de serrage LH



DONNÉES TECHNIQUES

- Anse en acier cémenté de 8,5 mm de diamètre
- L'anse, le boîtier et certains éléments de fermeture sont en acier spécial cémenté
- Dans la version R (clé prisonnière), la clé reste dans le cylindre lorsque l'antivol est ouvert; dans la version NR (clé non prisonnière) la clé s'enlève même lorsque l'antivol est ouvert

TECHNOLOGIE



Article	EAN 4003318	a mm	b mm	c mm	d mm	e mm	Poids g	Unité emb.
496 NR black	11258 4	78	96	69	59	110	450	6
496 NR black OE	11269 0	78	96	69	59	110	450	24
496 R black OE	19457 3	78	96	69	59	110	450	24
SH485/495	37552 1						56	6
Bandes de serrage LH	56240 2						48	1

ACH 2.0 ADAPTOR CHAIN



DONNÉES TECHNIQUES



- Chaîne à maillons carrés de 6 et 8 mm d'épaisseur en acier cémenté
- Inutile de verrouiller séparément l'anse
- Plusieurs possibilités de verrouillage à un point fixe
- Convient à tous les antivols de cadre ABUS ainsi qu'à l'Alarmbox 2.0
- Le revêtement de l'anneau du loop protège la peinture du vélo



VARIANTES



ST5950

Article	EAN 4003318	 mm	 cm	Poids g	Unité emb.
ACH 2.0 6KS/85 black	95369 9	6	85	760	6
ACH 2.0 6KS/85 black + ST5950	95371 2	6	85	840	6
ACH 2.0 6KS/100 black	95360 6	6	100	860	6
ACH 2.0 6KS/100 black + ST5950	95363 7	6	100	1130	6
ACH 2.0 6KS/130 black	95366 8	6	130	1140	6
ACH 2.0 8KS/85 black	95375 0	8	85	1190	6
ACH 2.0 8KS/85 black + ST5950	95376 7	8	85	1270	6
ACH 2.0 8KS/100 black	95373 6	8	100	1400	6

ADAPTOR CABLE



DONNÉES TECHNIQUES

- Câble en acier de 12 mm
- Plusieurs possibilités de verrouillage à un point fixe
- Convient à tous les antivols de cadre ABUS ainsi qu'à l'Alarmbox 2.0

Article	EAN 4003318	 mm	 cm	Poids g	Unité emb.
ACL 12/100 black	18243 3	12	100	416	6

IVYTEX ADAPTER CHAIN

CARACTÉRISTIQUES



ST 5950



VARIANTES



crossing grey



sparkling orange

DONNÉES TECHNIQUES

- Chaîne de connexion avec la gaine IvyTex
- Chaîne à profil carré fabriquée en alliage d'acier cémenté par nos soins
- Le revêtement durable en fibres synthétiques IvyTex résiste aux attaques des scies
- Le revêtement hydrophobe IvyTex repousse la saleté et l'humidité
- Chaîne carrée de 6 et 8 mm d'épaisseur en acier cémenté
- Gainage en plastique de l'anneau de la boucle afin de protéger la peinture contre les dommages
- Avec les antivols de cadre, aucun verrouillage séparé de l'anse n'est nécessaire
- Diverses possibilités de connexion à des objets fixes ou à plusieurs vélos
- Convient aux antivols de cadre ABUS et aux AlarmBox 2.0

TECHNOLOGIE



Article	EAN 4003318	Stärke mm	Poids g	Unité emb.
ACH IVY 6KS/85 black	68457 9	6	760	6
ACH IVY 6KS/85 crossing grey	68456 2	6	760	6
ACH IVY 6KS/85 sparkling orange	68458 6	6	760	6
ACH IVY 6KS/100 black	68460 9	6	860	6
ACH IVY 6KS/100 black +ST5950	69055 6	6	1064	6
ACH IVY 6KS/100 crossing grey	68459 3	6	860	6
ACH IVY 6KS/100 sparkling orange	68461 6	6	860	6
ACH IVY 6KS/130 black	68463 0	6	1140	6
ACH IVY 6KS/130 crossing grey	68462 3	6	1140	6
ACH IVY 6KS/130 sparkling orange	68464 7	6	1140	6
ACH IVY 8KS/100 black	68466 1	8	1400	6
ACH IVY 8KS/100 crossing grey	68465 4	8	1400	6
ACH IVY 8KS/100 sparkling orange	68467 8	8	1400	6

LES SERRURES DE BATTERIE

SERRURES DE BATTERIE

Accel Group

96518 BLO ACC IT3 T82 OE Service

96691 BLO ACC IT3 Xplus OE Service

Bike Fun

96514 BLO BFI IT1 T82 OE Service

Bosch

96515 BLO BOS AX1 T82 OE Service

96520 BLO BOS CTC IT3 T82 OE Service

96303 BLO BOS DT1 BK OE Service

96521 BLO BOS DT2 PLUS OE Service

96490 BLO BOS DT2 T82 CTC OE Service

96281 BLO BOS DT2 T82 OE Service

96502 BLO BOS DT2 XL T82 OE Service

96675 BLO BOS DT2 Xplus OE Service

96516 BLO BOS DT3 T82 OE Service

96517 BLO BOS DT3 T82 XL OE Service

96671 BLO BOS DT3 T83 OE Service

96685 BLO BOS DT3 XPlus 2X OE Service

96684 BLO BOS DT3 XPLUS OE Service

96686 BLO BOS DT3 XPlus XL OE Service

96673 BLO BOS IT2.1 Xplus OE Service

96301 BLO BOS IT3 T82 OE Service

96672 BLO BOS IT3 T83 OE Service

96563 BLO BOS RT2 PLUS OE Service

Bosch

96687 BLO BOS RT2 Xplus OE Service

96297 BLO BOS UNI T82 OE Service

Brose

96669 BLO BRO IT1 LC T83 OE Service

Cube

96677 BLO CUB IT1.B3 XPLUS OE Service

96679 BLO CUB IT2 XPLUS OE Service

96678 BLO CUB IT2.B3 XPLUS OE Service

Cycle Union

96682 BLO CYU IT1 XPLUS OE Service

Darfon

96300 BLO DAF UNI LC T83 OE Service

96513 BLO DAF UNI T82 OE Service

96692 BLO DAF UNI T83 OE Service

Fazua

96574 BLO FAZ IT1 PLUS OE Service

96690 BLO FAZ IT2 Xplus OE Service

Fit Biketec

96681 BLO FIT IT1 Xplus OE Service

Giant

96504 BLO GIA IT1 F T82 OE Service

Panasonic

96299 BLO PAN DT1 T82 OE Service

96570 BLO PAN IT1 PLUS OE Service

96674 BLO PAN IT1 XPLUS OE Service

Pexco

96577 BLO PEX IT2 PLUS OE Service

96565 BLO PEX IT3 PLUS OE Service

Phylon

96307 BLO PHY 11,3 T82 OE Service

Scott

96680 BLO SCO IT2 Xplus OE Service

Shimano

96572 BLO SHI DT1 PLUS OE Service

96575 BLO SHI IT2 PLUS OE Service

96507 BLO SHI IT2 T82 ASY OE Service

96676 BLO SHI IT2 XPLUS OE Service

96289 BLO SHI RT1 T82 OE Service

Specialized

96573 BLO SPE IT2 PLUS OE Service

96670 BLO SPE IT3 T83 OE Service

96683 BLO SPE IT3 Xplus OE Service

Trek

96509 BLO TRE IT1 T82 OE Service

ZEG

96491 BLO ZEG IT1 T82 OE Service

96571 BLO ZEG IT3 PLUS OE Service

96576 BLO ZEG IT5 PLUS OE Service

Winora

96566 BLO+BRA WIN IT1 PLUS OE Service

96567 BLO+BRA WIN IT2 PLUS OE Service

IT: Intégré

DT: Cadre

RT: Porte-bagage





SÉCURITÉS DIVERSES



CHAIN CLAW 10



black

Page 120

ALARMBOX 2.0



black

Page 122

ALARMBOX RC



black

Page 123

WCH90



black

Page 124

GRANIT™ WBA 100



black

Page 126

GRANIT™ WBA 75



black

Page 126

WBA 60



black

Page 127

WA 50



black

Page 127

SPORTFLEX 2504



black

Page 128

COMBIFLEX™



black

Page 129



neon

Page 129



midnight blue

Page 129



black + CHR

Page 129

COMBIFLEX™ TRAVELGUARD



black

Page 130



yellow

Page 130



red

Page 130

COMBIFLEX™ ADVENTURE



black

Page 130

COMBILOOP 205



black

Page 131

COBRA™



black

Page 132

1850



black

Page 132

**FEUERSTOPP
AFS625**



Page 133

PS 88



Page 133

**KEYGARAGE™
SMART 797**



Page 135

**KEYGARAGE™
SMART 787**



Page 135

**KEYGARAGE™
787 BIG LED**



Page 136

**KEYGARAGE™
787 BIG**



Page 136

**KEYGARAGE™
787 LED**



Page 137

**KEYGARAGE™
787**



Page 137

**KEYGARAGE™
797 LED**



Page 138

**KEYGARAGE™
797**



Page 138

**KEYGARAGE™
767**



Page 139

145



schwarz

Page 140



gelb

Page 140



orange

Page 140



rot

Page 140



lila

Page 140



blau

Page 140



grün

Page 140



silber

Page 140



titanium

Page 140

64 TITALIUM™



Page 141

70 & 70IB



70

Page 142



70IB

Page 142

**DISKUS®
24IB**



Page 142

**DISKUS®
20**



Page 143

147TSA



Page 143



CHAIN CLAW 10

NEW

NIVEAU DE SÉCURITÉ



DONNÉES TECHNIQUES

- Chaîne à maillons carrés de 7 mm d'épaisseur
- Les articulations pivotantes et les deux points d'enclenchement différents pour les menottes offrent une flexibilité maximale
- La chaîne ainsi que certaines parties du boîtier et des menottes sont fabriquées en acier spécialement cémenté
- Code à chiffres réglable individuellement

TECHNOLOGIE



Article	EAN	Diamètre mm	Longueur cm	Poids g	Unité emb.
Chain Claw 10 noir	4003318 95934 9	7	100	2500	1

ALARMBOX 2.0

VARIANTES



Alarmbox 2.0 black +
6KS/100



Alarmbox 2.0 black +
ACL 12/100

DONNÉES TECHNIQUES

- Fonction d'alarme avec min. 100 dB pendant 15 secondes, puis réarmement
- Détection de position 3D - système d'alarme qui détecte les vibrations et les plus petits mouvements dans les trois dimensions et déclenche l'alarme
- Alarme intelligente - En cas de chocs légers et courts, par exemple avec un ballon de football, le boîtier d'alarme n'émet qu'un bref signal sonore
- Pile CR2 incluse
- Possibilité de fixation sur presque toutes les géométries rondes
- Possibilité de raccordement de chaînes et de câbles d'adaptation ABUS

TECHNOLOGIE



Article	EAN 4003318	Poids g	Unité emb.
Alarmbox 2.0 noir	61482 8	430	12
Alarmbox 2.0 noir + ACH 6KS/100	61488 0	1720	6
Alarmbox 2.0 noir + ACL 12/100	61489 7	720	6

ALARMBOX RC

VARIANTES



DONNÉES TECHNIQUES

- Alarmbox avec télécommande
- Fonction alarme avec min. 100 dB pendant 15 secondes, puis réarmement
- Détection de position 3D - détecte les vibrations et les moindres mouvements dans les trois dimensions et déclenche l'alarme
- Alarme intelligente - en cas de chocs légers et courts, par exemple avec un ballon de football, le boîtier d'alarme n'émet qu'un bref signal sonore
- Activation et désactivation pratiques par télécommande
- Pile CR2 incluse (Alarmbox) / Pile CR2032 incluse (télécommande)
- Possibilité de fixation sur presque toutes les géométries rondes
- Très léger et donc idéal pour une utilisation dans les domaines du sport et de l'extérieur
- Diverses options de connexion telles que les colliers de serrage, le ruban adhésif double face, le Velcro, etc.

TECHNOLOGIE



Article	EAN 4003318	Poids g	Unité emb.
Alarmbox RC SingleSet noir	61487 3	82	12
Alarmbox RC TwinSet noir	69058 7	164	12
Alarmbox RC Box noir	69059 4	70	12
Alarmbox RC Télécommande noire	69060 0	16	12



WCH90

NIVEAU DE SÉCURITÉ



VARIANTES



WCH90 + ACH 9KS/130



WCH90 + ACH 9KS/130

DONNÉES TECHNIQUES

- Ancre murale avec chaîne intégrée
- Boîtier en acier cémenté pour une haute résistance
- L'ancre murale est fermement ancrée dans le mur à l'aide de chevilles spéciales de haute sécurité et offre ainsi un niveau extrêmement élevé de protection contre le vol
- Les chevilles de sécurité sont incluses dans l'emballage
- Convient uniquement pour un montage mural
- La chaîne et le boîtier sont en acier spécialement cémenté
- Revêtement textile pour protéger contre les dommages causés par la peinture
- Les chaînes sont disponibles en différentes longueurs
- Cylindre ABUS XPlus pour une protection extrêmement élevée contre la manipulation, par exemple le crochetage

TECHNOLOGIE



Article	EAN 4003318	Diamètre	Longueur	Poids g	Unité emb.
WCH90 + ACH 9KS/110	69061 7	9	110	3580	1
WCH90 + ACH 9KS/110 Twin Chain	69063 1	9	110	6620	1
WCH90 + ACH 9KS/130	69062 4	9	130	3960	1

GRANIT™ WBA 100

FEATURES



NIVEAU DE SÉCURITÉ



Niveau de Sécurité Moto

Article	EAN 4003318	mm	mm	mm	mm	mm	Poids g	Unité emb.
WBA100 GRANIT™	27161 8	160	165	16	65	77	1880	1

DONNÉES TECHNIQUES

- Oeillet en acier spécial cémenté de 16 mm de diamètre extrêmement résistant
- Accessoires de montage inclus

LOGOS D'AGRÈMENT



GRANIT™ WBA 75

FEATURES



NIVEAU DE SÉCURITÉ



Article	EAN 4003318	mm	mm	mm	mm	mm	Poids g	Unité emb.
WBA75 GRANIT™	78606 8	135	98	14	65	66	850	1

DONNÉES TECHNIQUES

- Oeillet en acier spécial cémenté de 14 mm de diamètre, extrêmement résistant
- Accessoires de montage inclus

LOGOS D'AGRÈMENT



WBA 60

FEATURES



NIVEAU DE SÉCURITÉ



DONNÉES TECHNIQUES

- Oeillet en acier spécial cémenté de 10 mm de diamètre, extrêmement résistant
- Accessoires de montage inclus

LOGOS D'AGRÉMENT



Article	EAN	 mm	 mm	 mm	 mm	 mm	Poids g	Unité emb.
WBA60	82211 7	118	80	10	52	55	450	1

WA 50

FEATURES







NIVEAU DE SÉCURITÉ



DONNÉES TECHNIQUES

- Ancre murale solide faite en acier special cémenté
- Accessoires de montage inclus

Article	EAN	 mm	 mm	 mm	 mm	Poids g	Unité emb.
WA50	04294 2	110	80	38	38	786	1

SPORTFLEX 2504



DONNÉES TECHNIQUES

- Antivol à câble très léger et peu encombrant à monter sous le porte-bidon
- Montage à l'aide de deux vis incluses dans l'emballage aux points de fixation sur le tube du cadre du vélo
- Le profil bas de 20 mm permet le montage sous un porte-bidon existant
- Câble auto-rétractable
- Code à chiffres réglable individuellement
- Idéal pour la protection contre les pickpockets et les voleurs occasionnels

TECHNOLOGIE



Article	EAN 4003318	Diamètre mm	Longueur cm	Poids g	Unité emb.
2504/90	69054 9	2,4	90	100	34

COMBIFLEX™

NEW



VARIANTES



neon



midnight blue



noir + CHR

DONNÉES TECHNIQUES

- Câble auto-rétractable
- Le code numérique est réglable et modifiable par l'utilisateur
- Format de poche attrayant qui se glisse facilement dans une poche
- Câble en acier extensible

TECHNOLOGIE



Article	EAN 4003318	mm	cm	Poids g	Unité emb.
Combiflex™ Stop0Unité emb.r 65	95454 2	1,2	65	46	1
Combiflex™ Stop0Unité emb.r 65 neon	95458 0	1,2	65	46	1
Combiflex™ Stop0Unité emb.r 65 midnight blue	95459 7	1,2	65	46	1
Combiflex™ Break 85 noir	95455 9	1,5	85	58	1
Combiflex™ Break 85 neon	95460 3	1,5	85	58	1
Combiflex™ Break 85 midnight blue	95461 0	1,5	85	58	1
Combiflex™ Rest 105 noir	95456 6	2,4	105	80	1
Combiflex™ Rest 105 noir + CHR	95484 9	2,4	105	120	1
Combiflex™ Trip 125 noir	95457 3	3	125	128	1

COMBIFLEX™ TRAVEL GUARD



DONNÉES TECHNIQUES

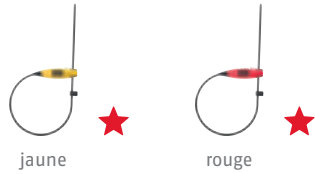

- Protection de câble avec armature en acier extra solide
- Code numérique à 3 chiffres réglable et modifiable par l'utilisateur
- Sécurité du câble avec mécanisme de fermeture amovible
- Petit et léger, se glisse facilement dans la poche du pantalon ou du maillot

VARIANTES



TECHNOLOGIE



Article	EAN 4003318	 mm	 cm	Poids g	Unité emb.
Combiflex™ Travel Guard noir	95468 9	4	45	86	6
Combiflex™ Travel Guard jaune	95601 0	4	45	86	6
Combiflex™ Travel Guard rouge	95600 3	4	45	86	6

COMBIFLEX™ ADVENTURE



DONNÉES TECHNIQUES

- Antivol à câble compact avec câble rétractable
- Code numérique à 3 chiffres réglable et modifiable par l'utilisateur
- Format de poche attrayant qui se glisse facilement dans une poche
- Câble en acier de 4 mm de diamètre et 78 cm de long



TECHNOLOGIE



Article	EAN 4003318	 mm	 cm	Poids g	Unité emb.
Combiflex™ Adventure	95465 8	4	75	145	3

COMBILoop 205

NIVEAU DE SÉCURITÉ



DONNÉES TECHNIQUES

- Cable de 5 mm en acier solide
- Revêtement synthétique pour protéger la peinture du vélo
- Fermeture automatique à l'insertion du boulon de verrouillage
- Programmation individuelle du code

TECHNOLOGIE





Article	EAN	 mm	 cm	Poids g	Unité emb.
205/200 noir	4003318 52523 0	5	200	180	12



DONNÉES TECHNIQUES

- Câble en acier de haute qualité, terminé par deux boucles de chaque côté
- Revêtement synthétique pour protéger contre tout incidents

Article	EAN 4003318	 mm	 cm	Poids g	Unité emb.
Cobra™ 5/75 noir	37106 6	5	75	75	100
Cobra™ 8/200 noir	25718 6	8	200	280	24
Cobra™ 8/250 noir	27390 2	8	250	395	16
Cobra™ 10/140 noir	37107 3	10	140	310	30
Cobra™ 10/200 noir	11167 9	10	200	400	28
Cobra™ 10/220 noir	37108 0	10	220	420	24
Cobra™ 10/300 noir	59930 9	10	300	560	21
Cobra™ 10/500 noir	20780 8	10	500	850	15
Cobra™ 10/1000 noir	20781 5	10	1000	1580	9
Cobra™ 12/120 noir	25719 3	12	120	380	15
Cobra™ 12/180 noir	27391 9	12	180	490	15

1850



DONNÉES TECHNIQUES

- Câble en acier de haute qualité, terminé par deux boucles de chaque côté
- Revêtement synthétique pour protéger contre tout incidents

Article	EAN 4003318	 mm	 cm	Poids g	Unité emb.
1850/185	12752 6	8	185	280	18



KEYGARAGE™ SMART 797



TECHNOLOGIE



DONNÉES TECHNIQUES

- Boîtier métallique grand et solide pour ranger de nombreuses clés
- Clavier électronique éclairé pour la saisie d'un code à 6 chiffres
- Gestion et utilisation de KeyGarage™ via l'application HomeTec Pro Bluetooth
- Partager et accorder des autorisations d'accès via l'application mobile
- Visualisation de l'historique de connexion et des utilisateurs actuels
- Permet de déposer jusqu'à 20 clés, 3 clés de voiture ou 30 cartes
- Crochet à clés intégré pour suspendre des clés/des trousseaux de clés
- Verrouillage automatique certifié selon IP5
- Compartiment à piles accessible de l'extérieur pour 2 piles AA
- Accès rapide et facile pour des groupes de personnes changeant fréquemment (p. ex artisans, assistance, vacanciers, location de véhicules, immeubles, service infirmier)
- Possibilité d'accès grâce à la génération et la transmission d'un code chiffré ou via l'envoi d'un ticket d'accès électronique grâce à l'application Bluetooth HomeTec Pro
- Fixation avec anse pour une utilisation flexible et temporaire dans une zone intérieure ou extérieure sous abri (p. ex. sur une poignée de porte)

Article	EAN 4003318	 mm	 mm	 mm	Poids g	Unité emb.
797 SMART-BT avec anse	63825 1	82,5	63	179	888	1

KEYGARAGE™ SMART 787





TECHNOLOGIE



DONNÉES TECHNIQUES

- Boîtier métallique grand et solide pour ranger de nombreuses clés
- Clavier électronique éclairé pour la saisie d'un code à 6 chiffres
- Gestion et utilisation de KeyGarage™ via l'application HomeTec Pro Bluetooth
- Partager et accorder des autorisations d'accès via l'application mobile
- Visualisation de l'historique de connexion et des utilisateurs actuels
- Permet de déposer jusqu'à 20 clés, 3 clés de voiture ou 30 cartes
- Crochet à clés intégré pour suspendre des clés/des trousseaux de clés
- Verrouillage automatique certifié selon IP5
- Compartiment à piles accessible de l'extérieur pour 2 piles AA
- Accès rapide et facile pour des groupes de personnes changeant fréquemment (p. ex artisans, assistance, vacanciers, location de véhicules, immeubles, service infirmier)
- Possibilité d'accès grâce à la génération et la transmission d'un code chiffré ou via l'envoi d'un ticket d'accès électronique grâce à l'application Bluetooth HomeTec Pro

Article	EAN 4003318	 mm	 mm	 mm	Poids g	Unité emb.
787 SMART-BT montage mural	63824 4	82,5	63	120	883	1

KEYGARAGE™ 787 BIG LED



TECHNOLOGIE



DONNÉES TECHNIQUES

- Boîtier métallique solide
- Clapet en zinc moulé sous pression avec molettes à chiffres
- Code à 4 chiffres personnalisables
- Molette à chiffres éclairée pour une meilleure lisibilité dans les environnements sombres
- Les LED s'allument pendant env. 30 secondes
- Pile bouton standard (CR2032) facile à remplacer, durée de vie en utilisation normale (1x/Jour) : env. 2 ans
- Clapet de protection avec mécanisme coulissant
- Montage mural avec des vis
- Permet de déposer jusqu'à 14 cartes plastiques ou 20 clés (787 LED) ou jusqu'à 30 cartes plastiques ou 50 clés (787 BIG LED)
- Crochet à clés amovible pour plus de confort lors du rangement des clés
- Dimensions extérieures du boîtier : 84 x 120 x 42 (787 LED) / 84 x 120 x 62 (787 BIG LED)
- Pour le stockage sécurisé de clés ou de petits objets de valeur pour les personnes autorisées
- Accès rapide et facile pour des groupes de personnes changeant fréquemment (artisans, assistance, vacanciers,, immeubles, location de vélos)
- Possibilité d'accès en définissant et transmettant le code à chiffres
- Pour un montage encastré en intérieur ou en extérieur sous abri
- Le stockage d'un trousseau clés est possible grâce à un plus grand espace et à un crochet amovible

Article	EAN 4003318	 mm	 mm	 mm	Poids g	Unité emb.
787 BIG LED wall mounting	83856 9	84	62	120	880	1

KEYGARAGE™ 787 BIG





TECHNOLOGIE



DONNÉES TECHNIQUES

- Boîtier métallique solide
- Clapet en zinc coulé sous pression
- Combinaison à 4 chiffres à programmation individuelle
- Clapet d'ouverture coulissant
- Fixation murale avec des vis
- Permet de déposer 30 cartes ou 50 clés
- Le crochet de clé peut être enlevé
- Très large espace de rangement
- Dimensions extérieures du boîtier : 84 x 120 x 62
- Pour la conservation de clés p. ex. pour les personnes autorisées
- Accès rapide et facile pour des groupes de personnes changeant fréquemment (artisans, assistance, vacanciers, immeubles, location de vélos)
- Détermination de la possibilité d'accès en choisissant et transmettant le code à chiffres
- Pour montage mural en intérieur ou en extérieur dans une zone protégée
- Exemple: Dépôt de clés ou de cartes plastiques à code

Article	EAN 4003318	 mm	 mm	 mm	Poids g	Unité emb.
787 BIG wall mounting	08492 8	83,5	62	120	850	1

KEYGARAGE™ 787 LED



TECHNOLOGIE



DONNÉES TECHNIQUES

- Boîtier métallique solide
- Clapet en zinc moulé sous pression avec molettes à chiffres
- Code à 4 chiffres personnalisables
- Molette à chiffres éclairée pour une meilleure lisibilité dans les environnements sombres
- Les LED s'allument pendant env. 30 secondes
- Pile bouton standard (CR2032) facile à remplacer, durée de vie en utilisation normale (1x/Jour) : env. 2 ans
- Clapet de protection avec mécanisme coulissant
- Montage mural avec des vis
- Permet de déposer jusqu'à 14 cartes plastiques ou 20 clés (787 LED) ou jusqu'à 30 cartes plastiques ou 50 clés (787 BIG LED)
- Crochet à clés amovible pour plus de confort lors du rangement des clés
- Dimensions extérieures du boîtier : 84 x 120 x 42 (787 LED) / 84 x 120 x 62 (787 BIG LED)
- Pour le stockage sécurisé de clés ou de petits objets de valeur pour les personnes autorisées
- Accès rapide et facile pour des groupes de personnes changeant fréquemment (artisans, assistance, vacanciers,, immeubles, location de vélos)
- Possibilité d'accès en définissant et transmettant le code à chiffres
- Pour un montage encastré en intérieur ou en extérieur sous abri
- Le stockage d'un trousseau clés est possible grâce à un plus grand espace et à un crochet amovible

Article	EAN 4003318	 mm	 mm	 mm	Poids g	Unité emb.
787 LED wall mounting	83854 5	84	42	120	740	1

KEYGARAGE™ 787





TECHNOLOGIE



DONNÉES TECHNIQUES

- Boîtier métallique robuste
- Clapet en zinc coulé sous pression
- Code personnalisable à 4 chiffres
- Clapet de protection avec mécanisme coulissant
- Fixation murale avec des vis
- Permet de déposer 14 cartes ou 20 clés
- Dimensions extérieures du boîtier : 80 x 120 x 45
- Crochet à clés amovible pour plus de confort lors du rangement des clés
- Pour la conservation de clés p. ex. pour les personnes autorisées
- Accès rapide et facile pour des groupes de personnes changeant fréquemment (artisans, assistance, vacanciers, immeubles, location de vélos)
- Détermination de la possibilité d'accès en choisissant et transmettant le code à chiffres
- Pour montage mural, en intérieur comme en extérieur sous abri

Article	EAN 4003318	 mm	 mm	 mm	Poids g	Unité emb.
787 wall mounting	46331 0	80	45	120	662	1

KEYGARAGE™ 797 LED



FEATURES



Adapter



TECHNOLOGIE



DONNÉES TECHNIQUES

- Boîtier en métal solide
- Clapet en zinc moulé sous pression
- Code à 4 chiffres personnalisables
- Molette à chiffres éclairée pour une meilleure lisibilité dans les environnements sombres
- Les LED s'allument pendant env. 30 secondes
- Pile bouton standard (CR2032) facile à remplacer, durée de vie en utilisation normale (1x/Jour) : env. 2 ans
- Clapet de protection avec mécanisme coulissant
- Avec anse pour une fixation sur la poignée de porte p. ex.
- Capacité de stockage de 14 cartes ou 20 clés
- Dimensions extérieures du boîtier : 84 x 120 x 44
- Boîtier et anse avec revêtement en plastique pour protéger des rayures
- Pour le stockage sécurisé de clés ou de petits objets de valeur pour les personnes autorisées
- Accès rapide et facile pour des groupes de personnes changeant fréquemment (artisans, assistance, vacanciers, immeubles, location de vélos)
- Possibilité d'accès en définissant et transmettant le code à chiffres
- Fixation avec l'anse pour une utilisation flexible et temporaire, p. ex. sur une poignée de porte, une rambarde ou une poignée

Article

Article	EAN 4003318	 mm	 mm	 mm	Poids g	Unité emb.
797 LED with shackle	83855 2	84	44	120	843	1
Adapter KeyGarage™ 777 + 797	56321 8	70	74	63	114	1

KEYGARAGE™ 797



FEATURES



Adapter



TECHNOLOGIE



DONNÉES TECHNIQUES

- Boîtier métallique robuste
- Clapet en zinc coulé sous pression
- Code personnalisable à 4 chiffres
- Clapet de protection avec mécanisme coulissant
- Avec anse pour une fixation sur la poignée de porte p. ex.
- Permet de déposer 14 cartes ou 20 clés
- Dimensions extérieures du boîtier: 85 x 120 x 45
- Boîtier et anse recouverts de la matière plastique protégée ainsi votre porte des rayures
- Pour la conservation de clés p. ex. pour les personnes autorisées
- Accès rapide et facile pour des groupes de personnes changeant fréquemment (artisans, assistance, vacanciers, immeubles, location de vélos)
- Détermination de la possibilité d'accès en choisissant et transmettant le code à chiffres
- Fixation avec anse p. ex. aux boutons de porte, aux poignées ou aux poignées en étrier

Article

Article	EAN 4003318	 mm	 mm	 mm	Poids g	Unité emb.
797 with shackle	46330 3	85	45	180	770	1
Adapter KeyGarage™ 777 + 797	56321 8	70	74	63	114	1

KEYGARAGE™ 767



FEATURES



TECHNOLOGIE



DONNÉES TECHNIQUES

- Boîtier métallique robuste
- Clapet en zinc coulé sous pression
- Combinaison interchangeable à 10 codes bouton-poussoir: Mettez votre code personnel
- Le code à chiffres doit également être saisi pour fermer le capuchon de fermeture
- Clapet d'ouverture coulissant
- Pour un montage au mur, à l'aide des vis
- Permet de déposer 17 cartes ou 20 clés
- Dimensions extérieures du boîtier: 84 x 119 x 47
- Pour la conservation de clés p. ex. pour les personnes autorisées
- Accès rapide et facile pour des groupes de personnes changeant fréquemment (artisans, assistance, vacanciers, immeubles, location de vélos)
- Détermination de la possibilité d'accès en choisissant et transmettant le code à chiffres
- Pour montage mural, en intérieur comme en extérieur sous abri

Article

EAN
4003318



mm



mm



mm

Poids
g

648

Unité
emb.

1

767 wall mounting

53507 9

80

45

120



DONNÉES TECHNIQUES

- Boîtier de cadenas massif en aluminium à revêtement anodisé – résistant à la corrosion
- L'anse est sur ressort pour un meilleur ajustement de la combinaison d'ouverture
- 145/20 et 145/30: Code individuel personnalisable à 3 chiffres
- 145/40: Code individuel personnalisable à 4 chiffres
- Utilisation confortable sans clé, poids faible
- Grande facilité d'identification grâce aux couleurs vives
- 145/20 et 145/30: Protection d'objets de petite valeur ou avec un risque de vol faible
- 145/40: Protection d'objets de moyenne valeur / d'objets avec un risque de vol moyen
- Par exemple pour la protection de bagages, de casiers dans les écoles et les centres sportifs, de cassettes, de coffres, de caisses à outils, d'installations électriques, etc.

VARIANTES



154/20 jaune



145/20 orange



145/20 rouge



145/20 violet



145/20 bleu









145/20 vert



145/20 argent



145/20 titane

Article	EAN 4003318	 mm	 mm	 mm	 mm	 mm	 mm	Poids g	Unité emb.
145/20 jaune B/DFNLI	46552 9	22,5	9	22	3	13,5	52,5	25	6
145/20 orange B/DFNLI	46550 5	22,5	9	22	3	13,5	52,5	25	6
145/20 rouge B/DFNLI	46549 9	22,5	9	22	3	13,5	52,5	25	6
145/20 violet B/DFNLI	46553 6	22,5	9	22	3	13,5	52,5	25	6
145/20 bleu B/DFNLI	46548 2	22,5	9	22	3	13,5	52,5	25	6
145/20 vert B/DFNLI	46551 2	22,5	9	22	3	13,5	52,5	25	6
145/20 argent B/DFNLI	46554 3	22,5	9	22	3	13,5	52,5	25	6
145/20 titane B/DFNLI	46556 7	22,5	9	22	3	13,5	52,5	25	6
145/20 black B/DFNLI	34609 5	22,5	9	22	3	13,5	52,5	25	6
145/30 jaune B/DFNLI	46561 1	31,5	14	25	5	15,5	65	55	6
145/30 orange B/DFNLI	46559 8	31,5	14	25	5	15,5	65	55	6
145/30 rouge B/DFNLI	46558 1	31,5	14	25	5	15,5	65	55	6
145/30 violet B/DFNLI	46562 8	31,5	14	25	5	15,5	65	55	6
145/30 bleu B/DFNLI	46557 4	31,5	14	25	5	15,5	65	55	6
145/30 vert B/DFNLI	46560 4	31,5	14	25	5	15,5	65	55	6
145/30 argent B/DFNLI	46563 5	31,5	14	25	5	15,5	65	55	6
145/30 titane B/DFNLI	46565 9	31,5	14	25	5	15,5	65	55	6
145/30 black B/DFNLI	34610 1	31,5	14	25	5	15,5	65	55	6
145/40 jaune B/DFNLI	49534 2	41,5	21,5	26	6	17,5	77	110	6
145/40 orange B/DFNLI	49526 7	41,5	21,5	26	6	17,5	77	110	6
145/40 rouge B/DFNLI	48830 6	41,5	21,5	26	6	17,5	77	110	6
145/40 bleu B/DFNLI	49522 9	41,5	21,5	26	6	17,5	77	110	6
145/40 vert B/DFNLI	49530 4	41,5	21,5	26	6	17,5	77	110	6
145/40 argent B/DFNLI	49542 7	41,5	21,5	26	6	17,5	77	110	6
145/40 titane B/DFNLI	49550 2	41,5	21,5	26	6	17,5	77	110	6

64 TITALIUM™



DONNÉES TECHNIQUES

- Corps de cadenas massif en aluminium spécial TITALIUM™
- Anse en acier spécial cémenté avec revêtement NANO PROTECT™ pour une meilleure résistance à la corrosion
- 64TI/50HB60-150: Anse amovible et de taille réglable entre 60 et 150 mm
- Profil de clé paracentrique pour une protection élevée contre les effractions
- Double verrouillage de l'anse
- Cœur du cylindre chromé pour une protection accrue contre la corrosion
- Tête de clé en forme de tulipe
- Protection d'objets de moyenne valeur ou présentant un risque de vol moyen
- Pour la sécurisation de chaînes, de portes, de portails, d'armoires, de casiers, de boîtes à outils, de fenêtres de cave ou de remises.

VARIANTES



64TI/20 B/DFNLI



64TI/25 B/DFNLI



64TI/30 B/DFNLI



64TI/30HB60 B/DFNLI



64TI/35 B/DFNLI









64TI/40HB40 B/DFNLI



64TI/40HB63 B/DFNLI



64TI/45 B/DFNLI

Article	EAN 4003318	 mm	 mm	 mm	 mm	 mm	 mm	Poids g	Unité emb.
64TI/20 B/DFNLI	56384 3	20	9,5	11,5	3,5	10,5	34	21	6
64TI/25 B/DFNLI	56386 7	24,5	13	13,5	4	12	42	31	6
64TI/30 B/DFNLI	56387 4	30	16	17	5	13	50	53	12
64TI/30HB60 B/DFNLI	56388 1	30	16	60	5	13	93	65	6
64TI/35 B/DFNLI	56390 4	35	19	20	5,5	14	54	67	6
64TI/40 B/DFNLI	56391 1	40	22	23	6	15	62	87	6
64TI/40HB40 B/DFNLI	56392 8	40	22	40	6	15	79	96	3
64TI/40HB63 B/DFNLI	56393 5	40	22	63	6	15	102	107	3
64TI/45 B/DFNLI	56398 0	45	25	24	7	15	68	109	6
64TI/50 B/DFNLI	56399 7	50	28	29	8	17	77	159	6
64TI/50HB80 B/DFNLI	56400 0	50	28	80	8	17	128	199	6
64TI/50HB60-150 B/DFNLI	89490 9	50	28	60-150	8	17	77	281	4
64TI/50HB60-150 gl.	63308 9	50	28	60-150	8	17	77	281	3
64TI/60 B/DFNLI	56401 7	60	34	35	10	19	91	236	4

70 & 70IB



DONNÉES TECHNIQUES

- Boîtier en laiton massif
- Anse en acier cémenté avec gaine plastique
- Boîtier encapsulé avec clapet protecteur spécial et canaux de drainage pour la protection de la serrure contre l'eau et la saleté
- Une gaine plastique résiliente protège les surfaces sensibles
- Double verrouillage
- Cylindre à goupilles de précision
- Profil de clé paracentrique pour une protection élevée contre les effractions
- Pièces intérieures en matériaux inoxydables
- Verrouillage automatique: verrouillage sans clé par enfoncement de l'anse
- Protection d'objets de moyenne valeur ou avec un risque de vol modéré
- Pour la protection de chaînes, portes, portails, armoires, casiers, caisses à outils, soupiroux, hangars, installations électriques ...
- Convient également pour une utilisation en extérieur

VARIANTES



70/45HB63









70IB/45



70IB/50



70IB/45HB63







Article	EAN 4003318	 mm	 mm	 mm	 mm	 mm	 mm	Poids g	Unité emb.
70/45 B/DFNLI	321 30 6	49	20	24	8	27,5	74	180	6
70/45HB63 B/DFNLI	321 31 3	49	20	63	8	27,5	112	210	6
70IB/45 B/DFNLI	321 32 0	49	20	24	8	27,5	74	180	6
70IB/45HB63 B/DFNLI	358 34 0	49	20	63	8	27,5	112	210	6
70IB/50 B/DFNLI	427 33 6	55	23,5	27,5	9	31	81,5	232	6

DISKUS® 24IB



DONNÉES TECHNIQUES

- Boîtier, intérieur et anse intégralement en acier inoxydable pour une protection anti-corrosion maximale
- Masquage des cylindres - protection maximale contre la saleté et les projections d'eau (uniquement pour 60 et 70 mm)
- Cylindre nickelé pour une protection optimale contre les intempéries
- Original Diskus® design: protection à 360°
- Technique de soudage Diskus® - Résistance maximale
- Cylindre à goupilles de précision
- Fermeture obligatoire: verrouillage uniquement avec la clé (la clé ne peut pas être retirée quand le cadenas est ouvert)
- Made in Germany
- Protection pour les objets de grande valeur ou à haut risque de vol
- Idéal pour une protection contre les fortes intempéries (par exemple en mer, dans les ports, pour la protection des véhicules et des bateaux en extérieur)
- Pour la protection des camions, portes, caves, armoires et hangars







Article	EAN 4003318	 mm	 mm	 mm	 mm	 mm	 mm	Poids g	Unité emb.
24IB/50 B/DFNLI	321 23 8	51	13	8	6,5	25,5	50	143	6
24IB/60 B/DFNLI	350 42 9	60	17	13	8	26	60	220	6
24IB/70 B/DFNLI	321 24 5	70	20	17	10	31	70	320	6

DISKUS® 20



DONNÉES TECHNIQUES

- Acier inoxydable - à l'intérieur et à l'extérieur
- Protection supplémentaire contre les scies
- Anse en acier cémenté spécial
- Cylindre à disque ABUS Plus: précision maximale contre les manipulations, nombre de fermetures extrêmement élevé
- Masquage des cylindres - protection maximale contre la saleté et les projections d'eau
- Technologie de soudage Diskus® - la meilleure protection contre les effractions
- Original Diskus® design: protection à 360°
- Fermeture obligatoire: verrouillage uniquement avec la clé (la clé ne peut pas être retirée quand le cadenas est ouvert)
- Made in Germany
- Deux clés incluses
- Protection d'objets de grande valeur ou avec un risque de vol très élevé
- Pour la protection de camions, d'utilitaires, d'entrepôts d'usine, de portes de caves, etc.
- Idéal en combinaison avec morillons ABUS Diskus® 140, empêchant l'accès à l'anse avec des outils d'effraction

Article	EAN 4003318	 mm	 mm	 mm	 mm	 mm	 mm	Poids g	Unité emb.
20/70 vs.	08854 4	70	20	17	10	30,5	70	330	6
20/80 vs.	08798 1	80	25	18	11	35,5	81	469	3
20/70 B/DFNLI	35023 8	70	20	17	10	30,5	70	367	3
20/80 B/DFNLI	35024 5	80	25	18	11	35,5	81	469	3

147TSA









TECHNOLOGIE



DONNÉES TECHNIQUES

- Corps de cadenas en plastique
- Epaisseur de l'anse 3 mm
- Code personnalisable à 3 chiffres
- Indicateur rouge visible à l'anse: le cadenas a été ouvert par TSA. Pour réinitialiser l'indicateur rouge, ouvrir le cadenas et tourner l'anse de 360°
- Para repor o indicador para uma nova viagem, rodar o arco 360°
- Protection d'objets de petite valeur ou avec un risque de vol faible
- Convient par exemple pour la sécurisation des bagages
- Idéal pour les voyages aux États-Unis: ouverture et fermeture des bagages par les douanes américaine sans risque de dommage pour le cadenas

Article	EAN 4003318	 mm	 mm	 mm	 mm	 mm	 mm	Poids g	Unité emb.
147TSA/30 B	53093 7	33	13	20	3	14	60	28	12

SUPPORTS D 'ANTIVOLS ET SACOCHES





SH B

black

Page 148



USKF

black

Page 149



Eazy KFTM

black

Page 149

**USH 540 / 470 /
460 / 440A**



black

Page 149



GH 50

black

Page 150



UGH 02

black

Page 150



SHACKLE CLAMP

black

Page 150



SADDLEFIX SH SF

black

Page 151



SH 6500A SMARTX™

black

Page 151



SH 6500K BORDO™

black

Page 151



SH 6500 BORDO™ BIG

black

Page 152



SH 6000 BORDO™

black

Page 152



SH FL

black

Page 152



SH 6000 BORDO™ BIG

black

Page 153



SH 5700 BORDO™

black

Page 153



**SH 5700
UGRIP BORDO™ BIG**

black

Page 153



SH 6055 BORDO™ LITE

black

Page 154



SR 6055 BORDO™

black

Page 154

ST 6000 BORDO™



black

Page 154

ST 6000 BORDO™ BIG



black

Page 155

ST 5700 UGRIP BORDO™



black

Page 155

IVERA RBU



black

Page 155

QUICK STORE QST



black

Page 156

SADDLEFIX QST



black

Page 156

ST 2012



black

Page 156

ST 5850 / 5650 / 4960

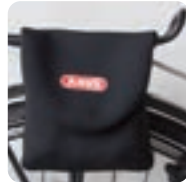

black

Page 157

SNAP CAGE



black

Page 157

SCLL



black

Page 157

SELLE ROYAL (5C, 5K, 6C, 6K)



black

Page 158

FIDLOCK FL



black

Page 158

FIDLOCK TEXFL



black

Page 158

TEXKF MINI



black

Page 159

QUICKSNAP RBU



black

Page 159

QUICKSNAP



black

Page 159

KF



black

Page 160

URB



black

Page 160

**ADAPTATEUR
STRAP LH**



black

Page 160

**ORYDE
ST 2250**



black

Page 161

**ORYDE
ST 2200**



black

Page 161

**ORYDE
ST 2085**



black

Page 161

**ORYDE
ST 2100**



black

Page 162

**BASICO
ST 5200**



black

Page 162

ST 5950 2.0



black

Page 162

SH B



DONNÉES TECHNIQUES

- Support d'antivol universel pour de nombreux antivols ABUS
- Le support convient aux antivols en U avec une anse carrée ou ronde
- Permet le transport de l'antivol sur différents endroits du vélo
- Le support permet une fixation horizontale ou verticale au niveau du cadre
- Convient pour les antivols U 640, 540, 470, 460
- Manipulation rapide et intuitive
- Convient aux cadres de 20 à 55 mm de diamètre

Article	EAN 4003318	Poids g	Support d' antivols	Unité emb.
Support SH B	67899 8	150	pour 640, 540, 470, 460	1

USKF



DONNÉES TECHNIQUES

- Pour le transport des antivols U
- Fixation sur tous les tubes de cadres arrondis d'un diamètre de 18 à 70 mm
- Support en plastique avec incrustations en caoutchouc pour un meilleur montage
- Manipulation à une seule main
- Montage simple et rapide

Article	EAN 4003318	Poids g	Support d' antivols	Unité emb.
USKF	86143 7	65	pour 64/46/47/770A/540/460/470/640	1

EAZY KF™



DONNÉES TECHNIQUES

- Pour le transport des antivols U
- Fixation sur tout type de cadre arrondi (diamètre de 28 à 36 mm)
- Livré avec deux sachets de vis de deux longueurs
- Fixation au dessus des colliers de serrage à l'aide de pièces réglables
- Indicateur montrant que le système est bien verrouillé
- Manipulation à une seule main
- Montage rapide et simple
- Exécution brevetée

Article	EAN 4003318	Exécution	Poids g	Support d' antivols	Unité emb.
Support EaZy KF™	45342 7		95	pour 64/61/54/51/47/640/540 /470/460/770A	1
Support pour anse 11mm	45344 1	∅ 11 mm	22	pour 61/64 EaZy KF	1
Support pour anse 12mm	45347 2	∅ 12 mm	24	pour 460/470	1
Support pour anse 13mm	45343 4	∅ 13 mm	26	pour 540/770A	1
Support pour anse 13mm	45346 5	∅ 13 mm	28	pour 51/501	1

USH 540 / 470 / 460 / 440A



DONNÉES TECHNIQUES

- Pour le transport des antivols U
- Fixation sur tous les tubes de cadres arrondis d'un diamètre de 15 à 35 mm
- Fixation sur les parties latérales du porte-bagage
- Transport possible de l'antivol sur le triangle du cadre ou le long du vélo

Article	EAN 4003318	Exécution	Poids g	Support d' antivols	Unité emb.
USH 540	18576 2		150	pour 540	1
USH 460 / 470	18578 6		120	pour 460 / 470	1
USH 440 Tex	87553 3		96	pour 440A	1

GH 50



DONNÉES TECHNIQUES

- Pour le transport des antivols U
- Fixation au porte-bagage
- Fixation sur les parties latérales du porte-bagage

Article	EAN 4003318	Exécution	Poids g	Support d' antivols	Unité emb.
GH50	00904 4		196	pour 64, 51, 47, 46, 470, 460, 32	1

UGH 02



DONNÉES TECHNIQUES

- Pour le transport des antivols et des Steel-0-Flex
- Fixation au porte-bagage (diamètre de tubes de 5 à 16,5 mm)
- Se fixe sur tout type de porte-bagage
- Montage simple et rapide

Article	EAN 4003318	Exécution	Poids g	Support d' antivols	Unité emb.
UGH 02	26624 9		80	pour 32, 410, 440, 460, 420, 470, 640, 540, 770A, 59	1

SHACKLE CLAMP



DONNÉES TECHNIQUES

- Accessoire pour le transport des antivols U ABUS sur le support TUBUS LOCC, ou TexKF Twin ou RBKF Twin

Article	EAN 4003318	Exécution	Poids g	Support d' antivols	Unité emb.
Support pour anse 11mm	25580 9	Ø 11 mm	22	pour 64	1
Support pour anse 12mm	25604 2	Ø 12 mm	21	pour 46, 47, 460, 470, 640	1
Support pour anse 13mm	27348 3	Ø 13 mm	30	pour 540, 770A	1

SUPPORT SADDLEFIX SH SF



DONNÉES TECHNIQUES

- Adaptateur universel pour une fixation peu encombrante de divers antivols BORDO™ aux montants de la selle
- Le BORDO™ souhaité peut être fixé sur l'adaptateur avec le support correspondant
- Une protection contre les éclaboussures et les intempéries pour le BORDO™
- Les trous de l'adaptateur sont analogues à ceux d'un porte-bouteille d'eau, de sorte que celui-ci ou le SportFlex pourraient également être fixés à l'adaptateur
- Les vis sont comprises dans la livraison
- Adaptateur pour la fixation à la selle
- Convient aux supports SH 5700, 6000 et 6500

Article	EAN 4003318	Exécution	Poids g	Support d' antivols	Unité emb.
Support SH SF	67866 0	Avec protection	121	pour SH 5700C/80, SH 5700K/80, SH 6000C/90, SH 6000K/120, SH 6000K/90, SH 6500/85	3

SUPPORT SH6500A SMARTX™



DONNÉES TECHNIQUES

- Pour faciliter le transport du BORDO™ 6500A SmartX
- Montage facile par bande de serrage ou bande Velcro
- Le Bordo peut-être facilement retiré par l'avant
- Idéal pour les petites géométries de cadre

Article	EAN 4003318	Exécution	Poids g	Support d' antivols	Unité emb.
Support SH 6500A SmartX	63488 8		148	pour 6500A/110	1

SUPPORT SH 6500K BORDO™



DONNÉES TECHNIQUES

- Pour faciliter le transport du BORDO™ 6500K et 6500KA
- Montage facile par bande de serrage ou bande Velcro
- Le Bordo peut-être facilement retiré vers l'avant
- Idéal pour les petites géométries de cadre
- Support pour un transport sûr de l'antivol sur le vélo

Article	EAN 4003318	Exécution	Poids g	Support d' antivols	Unité emb.
Support SH 6500K/90	69051 8		195	pour 6500KA/90, 6500K/90	3
Support SH 6500K/120	96279 0		230	pour 6500K/120	3

SUPPORT SH 6500 BORDO™ BIG



DONNÉES TECHNIQUES

- Transport facile pour le BORDO™ 6500, 6500 Big et 6510
- Montage simple et sans outils grâce aux colliers de serrage
- Le Bordo peut être facilement retiré vers l'avant
- Parfait pour les petits cadres

Article	EAN 4003318	Exécution	Poids g	Support d' antivols	Unité emb.
Support SH 6500/85	61557 3		152	pour 6500/85	3
Support SH 6500/110	61556 6		172	pour 6500/110	3

SUPPORT SH 6000 BORDO™



DONNÉES TECHNIQUES

- Transport facile pour le BORDO™ 6000, 6015 et 6100
- Montage simple et sans outils grâce aux colliers de serrage
- Le Bordo peut être facilement retiré vers l'avant
- Parfait pour les petits cadres

Article	EAN 4003318	Exécution	Poids g	Support d' antivols	Unité emb.
Support SH 6000/90	61543 6		115	pour 6000/90, 6000K/90, 6000KA/90 und 6000C/90, 6000A/90, 6100/90	3

SUPPORT SH FL



DONNÉES TECHNIQUES

- Pour faciliter le transport du BORDO 6000K/90, 6000C/90 ou 6000KA/90
- Fixation magnétique facile et super rapide à Fidlock TWIST bike base
- Le Bordo peut-être facilement retiré vers l'avant
- Les BORDO 6000K/90 et 6000C/90 sont également disponibles séparément, sans support

Article	EAN 4003318	Exécution	Poids g	Support d' antivols	Unité emb.
Support SHFL 6000/90	88886 1		160	pour 6000/90, 6100/90, 6000A/90, 6000K/90, 6000C/90, 6000KA/90	3

SUPPORT SH 6000 BORDO™ BIG



DONNÉES TECHNIQUES

- Transport facile pour le BORDO™ 6000 Big
- Montage simple et sans outils grâce aux colliers de serrage
- Le Bordo peut être facilement retiré vers l'avant
- Parfait pour les petits cadres

Article	EAN 4003318	Exécution	Poids g	Support d' antivols	Unité emb.
Support SH 6000/120	61564 1		132	pour 6000/120, 6000K/120, 6000KA/120, 6000A/120	3

SUPPORT SH 5700 BORDO™



DONNÉES TECHNIQUES

- Pour le transport facile de l'antivol BORDO 5700K uGrip
- Montage sans outil grâce au tendeur pratique
- Le Bordo peut-être facilement retiré vers l'avant t
- Idéal pour les cadres de petite taille

Article	EAN 4003318	Exécution	Poids g	Support d' antivols	Unité emb.
Support SH 5700/80	61566 5		122	pour 5700K/80 und 5700C/80	3

SUPPORT SH 5700 UGRIP BORDO™ BIG



DONNÉES TECHNIQUES

- Pour le transport facile de l'antivol BORDO 5700 uGrip BIG
- Montage sans outil grâce au tendeur pratique
- Le Bordo peut-être facilement retiré vers l'avant
- Idéal pour les cadres de petite taille

Article	EAN 4003318	Exécution	Poids g	Support d' antivols	Unité emb.
Support SH 5700K/100	61571 9		122	pour 5700/100	3

SUPPORT SH 6055 BORDO™ LITE



DONNÉES TECHNIQUES

- Transport facile pour le BORDO™ 6055 Lite
- Montage simple et sans outils grâce aux colliers de serrage
- Le Bordo peut être facilement retiré vers l'avant
- Parfait pour les petits cadres

Article	EAN 4003318	Exécution	Poids g	Support d' antivols	Unité emb.
Support SH 6055	61572 6		60	pour 6055K/60, 6055K/85, 6055C/60 und 6055C/85	3

SUPPORT SR 6055 BORDO™



DONNÉES TECHNIQUES

- Pour transporter facilement le BORDO 6055 Lite et Lite Mini (versions Key et Combo)
- Montage facile sous les selles de la marque Selle Royal
- Idéal pour une utilisation sur le vélo de route

Article	EAN 4003318	Exécution	Poids g	Support d' antivols	Unité emb.
Support SR 6055 Selle Royal	63151 1		64	pour 6055K/60, 6055K/85, 6055C/60 und 6055C/85	3

SACOCHÉ ST 6000 BORDO™



DONNÉES TECHNIQUES

- Montage flexible grâce à une bandes velcro anti-glissements ou une vis au niveau du porte-bidon
- Transport facile grâce à son support pratique

Article	EAN 4003318	Exécution	Poids g	Support d' antivols	Unité emb.
ST 6000/90 black	54297 8		125	pour 6000K/90, 6000C/90	1

SACOCHÉ ST 6000 BORDO™ BIG



DONNÉES TECHNIQUES

- Convient pour le Bordo 6000 Big
- Montage flexible grâce à une bandes velcro anti-glissements ou une vis au niveau du porte-bidon
- Transport facile grâce à son support pratique

Article	EAN 4003318	Exécution	Poids g	Support d' antivols	Unité emb.
ST 6000/120 black	55327 1		160	pour 6000K/120	1

SACOCHÉ ST 5700 UGRIP BORDO™



DONNÉES TECHNIQUES

- Sacoche avec mécanisme facile, utilisation à une seule main
- Montage flexible grâce à une bandes velcro anti-glissements ou une vis au niveau du porte-bidon
- Transport facile grâce à son support pratique

Article	EAN 4003318	Exécution	Poids g	Support d' antivols	Unité emb.
ST 5700 uGrip BORDO	11284 3		103	pour 5700K/80	1

IVERA RBU



DONNÉES TECHNIQUES

- Transport des antivols Ivera (chaîne, câble et Steel-0-Flex)
- Fixation à des tubes de cadres arrondis et non arrondis (diamètre de 15 à 45 mm)
- Montage facile, adaptable au support LL

Article	EAN 4003318	Exécution	Poids g	Support d' antivols	Unité emb.
Support RBU IUnité emb.RA	58497 8		125	pour 7200, 7210, 7220 IUnité emb.RA	1

SUPPORT QUICK STORE QST



DONNÉES TECHNIQUES

- Pour un transport sûr et sans claquement des antivols à chaîne
- Pour les antivols à chaîne ABUS de 6-7 mm d'épaisseur et de 85-110 cm de longueur
- Montage facile avec des vis sur le logement du porte-bidon ou grâce à une fixation pratique par bande de serrage
- Peut être combiné avec le support SattleFix (SF QST) pour être placé sous la selle

Article	EAN 4003318	Exécution	Poids g	Support d' antivols	Unité emb.
QST	61493 4		260		1

SUPPORT SF QST



DONNÉES TECHNIQUES

- Adaptateur pour placer un support d'antivol sous la selle
- Adapté au support QST QuickStore
- Pour transporter facilement les antivols à chaîne de 6-7 mm d'épaisseur

Article	EAN 4003318	Exécution	Poids g	Support d' antivols	Unité emb.
SF QST	95585 3		65	Support QST Quickstore	1

CHAIN BAG ST 2012



DONNÉES TECHNIQUES

- Sacoche de transport pour chaînes antivols
- Montage facile à l'aide de bandes velcro ou des vis à fixer sur le porte bidon
- Isolation du froid et de la chaleur: Epaisseur de 2 mm en néoprène
- Fixation renforcée

Article	EAN 4003318	Exécution	Poids g	Support d' antivols	Unité emb.
ST 2012 Chain Bag	58496 1	Sacoche: 0.6 l	188		1

ST 5850/5650/4960



DONNÉES TECHNIQUES

- Sac pour le transport protégé des antivols de cadre et des accessoires
- Fixation pratique au porte-bagages

Article	EAN 4003318	Exécution	Poids g	Support d' antivols	Unité emb.
ST 5850/5650/4960	48647 0		100	sacoche de transport 160 mm / 250 mm / 50 mm	1

SUPPORT SNAP CAGE



DONNÉES TECHNIQUES

- Transport de Steel-0-Flex, câble et câble spiral
- Permet le transport d'antivol sur la tige de selle, sur le cadre et sur le porte-bagage
- Avec un diamètre de 15 - 55 mm
- Montage simple, rapide et sans outils

Article	EAN 4003318	Exécution	Poids g	Support d' antivols	Unité emb.
SCMU 4K/5K	20079 3		40	pour 6415K, 6512K, 6615K	12
SCMU 4C/5C	20080 9		40	pour 4508, 5510K, 5412K	12
SCMU 6K	20111 0		40	pour 4508C, 5412C, 5510C	12
SCMU 6C	20113 4		40	pour 6415C, 6512C, 6615C	12

SUPPORT SCLL



DONNÉES TECHNIQUES

- Transport pour antivols en câble, câble en spirale, et Steel-0-Flex
- Fixation au boulon de potence de la selle (diamètre 5-8 mm)
- Montage facile

Article	EAN 4003318	Exécution	Poids g	Support d' antivols	Unité emb.
SCLL 6C	87983 8		47	pour 6415C, 6512C, 6615C	12
SCLL 4K/5K	87982 1		47	pour 4508K, 510K, 5412K	12
SCLL 4C/5C	87981 4		47	pour 4508C, 5412C, 5510C	12
SCLL 6K	87984 5		47	pour 6415K, 6512K, 6615K	12

SUPPORT SELLE ROYALE (5C,5K,6C,6K)



DONNÉES TECHNIQUES

- Installation et utilisation faciles
- Compatible avec Selle Royal ICS

Article	EAN 4003318	Exécution	Poids g	Support d' antivols	Unité emb.
SH 5K Selle Royal	63484 0		45	pour 4508K, 5510K, 5412K	1
SH 5C Selle Royal	63485 7		45	pour 4508C, 5412C, 5510C	1
SH 6K Selle Royal	63486 4		45	pour 6415K, 6512K, 6615K	1
SH 6C Selle Royal	63487 1		45	pour 6415C, 6512C, 6615C	1

SUPPORT FIDLOCK FL



DONNÉES TECHNIQUES

- Exclusivement pour le transport du nouveau Phantom 8960, 8950 et 8940
- Pour un montage sans effort, utilisation facile du support magnétique
- Fixation au boulon de potence de la selle (diamètre 5-8 mm)
- Montage facile

Article	EAN 4003318	Exécution	Poids g	Support d' antivols	Unité emb.
Support FL	39729 5		61	pour Phantom 8960, 8950, 8940	1

SUPPORT FIDLOCK TEXFL



DONNÉES TECHNIQUES

- Exclusivement pour le transport du nouveau Phantom 8960, 8950 et 8940
- Pour un montage sans effort, utilisation facile du support magnétique
- Montage sur des cadres ronds et spécifiques de diamètre 21-80 mm
- Lanière flexible pour le montage

Article	EAN 4003318	Exécution	Poids g	Support d' antivols	Unité emb.
Support TexFL	39730 1		77	pour Phantom 8960, 8950, 8940	1

SUPPORT TEXKF MINI



DONNÉES TECHNIQUES

- Pour le transport des câbles-antivols, des câbles spirals et des antivols Steel-0-Flex
- Fixation sur des tubes de cadres arrondis et non arrondis (diamètre de 21 à 80 mm)
- Fixation à l'aide de bandes de serrage
- Fixation possible sur le triangle du cadre ou sur le côté du vélo
- Montage simple et rapide

Article	EAN 4003318	Exécution	Poids g	Support d' antivols	Unité emb.
TexKF Mini	23265 7		70	pour 640, 1460, 8950, 1450, 8940	1

SUPPORT QUICKSNAP RBU



DONNÉES TECHNIQUES

- Pour le transport des câbles-antivols et des Steel-0-Flex
- Fixation à des tubes de cadres arrondis et non arrondis (diamètre de 15 à 45 mm)
- Fixation grâce à des bandes de serrage
- Fixation possible au triangle de cadre ou sur le côté
- Montage simple et rapide

Article	EAN 4003318	Exécution	Poids g	Support d' antivols	Unité emb.
QuickSnap RBU	31487 2		40	pour 860, 870	6

QUICKSNAP



DONNÉES TECHNIQUES

- Pour le transport des câbles-antivols et des Steel-0-Flex
- Fixation au boulon de potence de la selle (diamètre de 5 à 8 mm)
- Montage facile

Article	EAN 4003318	Exécution	Poids g	Support d' antivols	Unité emb.
QuickSnap	31488 9		46	pour 860, 870	1

KF



DONNÉES TECHNIQUES

- Pour le transport des câbles-antivols, des câbles-antivols spiral et des Steel-0-Flex
- Fixation au boulon de potence de la selle (diamètre standard de 5 à 8 mm)
- Montage simple

Article	EAN 4003318	Exécution	Poids g	Support d' antivols	Unité emb.
KF	12433 4		42	pour 896, 895, 894, 885, 875, 1350, 1355, 1340, 1440, 1450, 1460	6

SUPPORT URB (UNIUNITÉ EMB.RSAL- RAHMENSUPPORT)



DONNÉES TECHNIQUES

- Accessoire pour le transport des antivols, adaptable au support LL
- Fixation au boulon de potence de la selle (diamètre de 25 à 35 mm)

Article	EAN 4003318	Exécution	Poids g	Support d' antivols	Unité emb.
URB	23312 8	∅ 25 - 35 mm	30	pour antivols avec le support „LL“	12

ADAPTATEUR STRAP LH



DONNÉES TECHNIQUES

- Aide au montage d'antivol de cadre sur le hauban

Article	EAN 4003318	Exécution	Poids g	Support d' antivols	Unité emb.
Bandes de serrage LH	56240 2		48	Pour tous les antivols à cadre ABUS	1

ORYDE ST 2250



DONNÉES TECHNIQUES

- Volume: 1,8 litres
- Matériaux résistants et imperméables 420D et Scotch Rip 58
- Forme robuste grâce à un rembourrage
- Bandes réfléchissantes
- Espace intérieur pratique avec porte-clés
- Grand espace de rangement
- Sacoche de cadre pour le quotidien et les loisirs

Article	EAN 4003318	Volume l	Largeur mm	Hauteur mm	Profondeur mm	Exécution	Unité emb.
ST 2250	08469 0	1,8	235	195	50	Attaches Velcro	1

ORYDE ST 2200



DONNÉES TECHNIQUES

- Volume: 1,2 litres
- Matériaux résistants et imperméables 420D et Scotch Rip 58
- Forme robuste grâce à un rembourrage
- Bandes réfléchissantes
- Espace intérieur pratique avec porte-clés
- Grand espace de rangement
- Sacoche de cadre pour le quotidien et les loisirs

Article	EAN 4003318	Volume l	Largeur mm	Hauteur mm	Profondeur mm	Exécution	Unité emb.
ST 2200	08470 6	1,2	255	100	50	Attaches Velcro	1

ORYDE ST 2085



DONNÉES TECHNIQUES

- Volume: 0,7 litre
- Matériaux résistants et imperméables 420D et Scotch Rip 58
- Forme solide grâce à un rembourrage en mousse expansée
- Bandes réfléchissantes
- Espace intérieur pratique avec porte-clés
- Pratique à remplir grâce au système ABUS Easy Flap
- Livrée avec une housse de pluie équipée d'un logo réfléchissant
- Sacoche de selle utilisable au quotidien, pour le sport et les loisirs

Article	EAN 4003318	Volume l	Largeur mm	Hauteur mm	Profondeur mm	Exécution	Unité emb.
ST 2085 KF	08479 9	0,7	75	70	145	KLICKfix® Support pour selle	6

ORYDE ST 2100



DONNÉES TECHNIQUES

- Volume: 1,2 litres
- Matériaux résistants et imperméables 420D et Scotch Rip 58
- Forme solide grâce à un rembourrage en mousse expansée
- Bandes réfléchissantes
- Espace intérieur pratique avec porte-clés
- Extensible: Volume supplémentaire grâce à un soufflet avec fermeture zippée
- Sacoche de selle utilisable au quotidien, pour le sport et les loisirs

Article	EAN 4003318	Volume l	Largeur mm	Hauteur mm	Profondeur mm	Exécution	Unité emb.
ST 2100 KF	08472 0	1,2	80	95	150	Klickfix®	6

BASICO ST 5200



DONNÉES TECHNIQUES

- Volume: 1,2 litres
- Matériaux résistants et hydrofuges
- Espace intérieur pratique
- Vaste compartiment principal
- Bandes réfléchissantes
- Sacoche de cadre pour le quotidien et les loisirs

Article	EAN 4003318	Volume l	Largeur mm	Hauteur mm	Profondeur mm	Exécution	Unité emb.
ST 5200	08482 9	1,2	255	110	65	Attaches Velcro	1

ST 5950 2.0



DONNÉES TECHNIQUES

- Sacoche de selle pour le quotidien et les loisirs

Article	EAN 4003318	Volume l	Largeur mm	Höhe mm	Profondeur mm	Exécution	Unité emb.
ST 5950 2.0	87510 6	0,6	160	85	90	Attaches Velcro	1





ONE KEY™ TOUT SIMPLEMENT. UNIQUE.

**FAITES FABRIQUER DES ANTIVOLS SUR- MESURE POUR VÉLOS
- FAITES TOUT FONCTIONNER AVEC UNE SEULE CLÉ !**

Un antivol pliable, un antivol de cadre, un cadenas et, pour les vélos électriques, un antivol de batterie - si vous voulez sécuriser votre vélo correctement, vous avez besoin de nombreux antivol. C'est pourquoi ABUS, avec le système ONE KEY, offre la possibilité de produire des antivol pour vos clients de telle sorte qu'ils puissent tous être actionnés avec une seule clé. Pas de désordre, pas de recherche de clés.

COMMENT FONCTIONNE ONE KEY™

C'est simple. Chaque antivol ABUS possède un code de clé individuel avec lequel il est possible de produire des clés ultérieures ou des antivol assortis, même des années après l'achat. Il suffit simplement que les antivol que les antivol d'ABUS soient équipés du même type de cylindre.



VISAGE FAMILIER - NOUVEAU DESIGN

En tant que fabricant de cylindres et d'antivols pour bicyclettes" by „vélos, ABUS a la possibilité unique sur le marché de produire des antivols individuels de manière à ce qu'ils puissent tous être utilisés avec une seule clé - C'est ce qu'on appelle le keyed alike (s'ouvrant). Il est important que les antivols soient compatibles entre eux.

Jusqu'à présent, nous avons marqué nos produits et nos campagnes avec ces icônes :

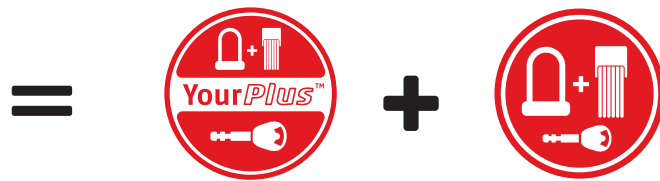

Avec YourPlus™, nous avons regroupé tous les antivols qui possèdent un cylindre Plus.

Cette icône indique actuellement que cet antivol est compatible avec le système de fermeture identique.

À PARTIR DE MAINTENANT, NOUS COMBINERONS TOUT SOUS ONE KEY™ - UNE PROMESSE CLAIRE POUR PLUS DE COMMODITÉ.

APERÇU DES PRODUITS À FERMETURE IDENTIQUE

PRODUITS AVEC CYLINDRE XPLUS

GRANIT™ Extreme 59
 GRANIT XPlus™ 540
 BORDO GRANIT XPlus™ 6500K
 BORDO GRANIT XPlus™ 6500KA
 BORDO™ 6000K
 BORDO™ 6000KA
 Chaîne GRANIT City XPlus™ 1060
 PRO SHIELD™ XPlus 5955
 SHIELD™ XPlus 5755L

PRODUITS AVEC CYLINDRE PLUS

GRANIT™ Plus 640
 GRANIT™ Plus 470
 CityChain™ 1010
 Steel-0-Chain™ 9809
 Steel-0-Chain™ 9808

CYLINDRE CE

GRANIT™ 460
 PHANTOM™ 8960

Supplément pour la fabrication de seulement 10% du prix de l'antivol.



UN CONFORT MAXIMAL POUR VOS CLIENTS

- + pas de chaos, pas de recherche de clés
- + pour les e-bikers avec antivol de batterie, cadre et cadenas
- + pour les familles avec plusieurs antivols
- + pour les couples ou les amis qui partagent leurs vélos

SERVICE CLÉ

Le service clé ABUS vous permet de commander directement la clé dont vous avez besoin pour vos serrures existantes.















Il suffit de choisir l'ébauche de la clé requise, de saisir ensuite le code souhaité et la clé commandée vous sera expédiée dans les plus brefs délais.



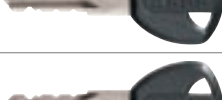











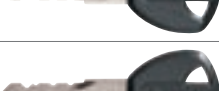

Si aucun numéro de clé n'est disponible, veuillez nous expédier le double de la clé d'origine.

Nous pourrions produire la copie exacte de votre clé.

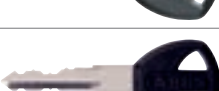
Pour toute demande de prix, veuillez contacter le service commercial.



	Type de clé	Code EAN	Numéro d'article
	XPlus (Clé lumineuse)	4003318357565	35756 5
	XPlus	4003318246579	24657 9
	Plus (Clé lumineuse)	4003318357572	35757 2
	Plus	4003318062278	06227 8
	8N	4003318816635	81663 5
	6N	4003318709777	70977 7
	T82	4003318561139	56113 9
	T83	4003318844867	84486 7
	F82	4003318815263	81526 3
	P82	4003318827044	82704 4
	E6	4003318822452	82245 2
	KC 54	4003318815270	81527 0
	ML54	4003318815287	81528 7
	NW52 noire	4003318546938	54693 8

	Type de clé	Code EAN	Numéro d'article
	NW72 rouge	4003318547539	54753 9
	PL1	4003318818684	81868 4
	RH 5	4003318835957	83595 7
	RH EC	4003318267666	26766 6
	U72	4003318815294	81529 4
	U73	4003318815300	81530 0
	U74	4003318815317	81531 7
	V61	4003318815324	81532 4
	V62	4003318815348	81534 8
	V63	4003318815331	81533 1
	V64	4003318815355	81535 5
	V65	4003318815362	81536 2
	Z72	4003318815379	81537 9
	Z73	4003318815386	81538 6
	Z74	4003318815393	81539 3
	ABUS - Bon d'achat pour clé Plus et XPlus	4003318043185	04318 5
	ABUS - Bon d'achat pour d'autres clés	4003318290015	29001 5

LE SYSTÈME DE NIVEAU ABUS

Pour trouver l'antivol qui convient à votre client, vous devez vous poser quelques questions qui peuvent vous aider dans le processus de sélection. Un antivol ne doit pas seulement être sûr, il doit aussi convenir à l'utilisateur.

Les questions ci-dessous peuvent vous aider à déterminer ce que recherche votre client :

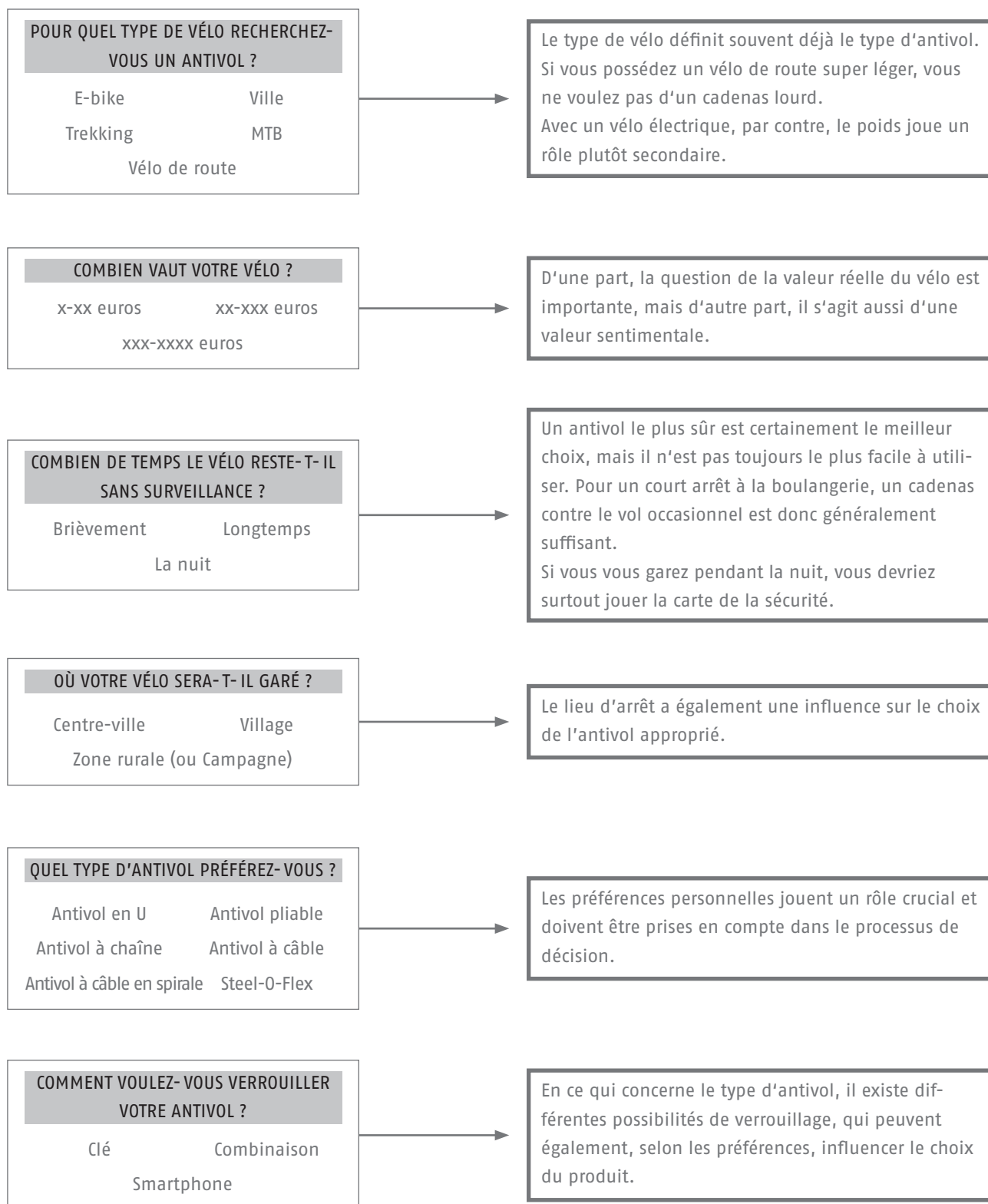

Lors d'un entretien pour une vente, vous avez un bon feeling avec votre client, et vous avez identifié son besoin. De nombreuses questions influencent le choix de l'antivol, mais pas tellement le choix du niveau de sécurité. Les facteurs les plus importants qui influencent le niveau de sécurité sont l'emplacement et la durée du stationnement.

Pour cela, nous vous recommandons le classement suivant :

Zone rurale



Petite ville / village



Centre-ville / métropole



Arrêt court



Quelques heures



La journée



De nuit

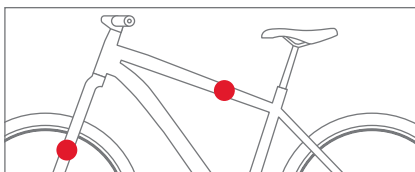

Verrouillez votre vélo dans une zone éclairée et fréquentée. Fixez votre vélo à un objet fixe et verrouillez le cadre et la roue avant. Gardez votre antivol aussi haut que possible et passez le à travers le cadre autant que vous le pouvez. L'attaque de l'antivol n'en sera que plus difficile.

ABUS OEM : PREMIÈRE MONTE

UN PARTENAIRE FORT, UN FOURNISSEUR FIABLE ABUS COMME PARTENAIRE OEM – VOTRE PREMIER CHOIX



Les facteurs décisifs sur le marché du vélo sont la plus-value, la différenciation, la flexibilité, la disponibilité, un service rapide et de grandes performances. Les fournisseurs qui collaborent avec des fabricants de vélos doivent répondre aux exigences requises. ABUS correspond à ce profil.

En tant que spécialistes à l'échelle internationale dans la sécurité mobile, nous vous offrons le meilleur soutien et nous vous garantissons une fiabilité optimale.

Depuis de nombreuses années, ABUS est synonyme de sécurité et la société est devenue un précurseur sur le marché des accessoires.

La qualité « Made in Germany » avec une livraison « Just in time » : Cet investissement dans ces compétences clés nous a permis de devenir un partenaire important pour de nombreux fabricants de vélos dans le monde entier. Par ailleurs, nous offrons en tant que partenaire

fort du marché OEM un vaste choix d'antivols de cadre, de nombreuses solutions de sécurité intégrées et de nombreux produits individuels. Nous fournissons entre autres des antivols avec des serrures à clé unique et des cylindres pour les batteries des vélos électriques - également disponibles en option.

Pour ces raisons : exploitons nos synergies communes afin d'emprunter le chemin du succès !

Notre équipe OEM est impatiente de vous lire.
Contact : contact@abus.fr

Nous sommes ravis de poursuivre notre bonne collaboration avec les leaders du marché du vélo !





BONTRAGER

SÉCURITÉ INDIVIDUELLE

Les solutions de sécurité intégrées ne sont pas seulement une tendance, elles sont aussi un moyen très confortable pour les cyclistes de mettre en sécurité leurs vélos tant appréciés. Profitez de notre expérience de plus de 90 ans et sortez du lot avec des solutions de sécurité sur-mesure.



SPONSORING

Chez ABUS, nous aimons ce que nous faisons et donnons le meilleur de nous-mêmes chaque jour.

Tout comme les athlètes des différentes disciplines, avec lesquels nous travaillons depuis des années dans un esprit de confiance. C'est un partenariat d'égal à égal, où chacun apporte ses connaissances et peut compter sur l'autre.

Ensemble, nous nous rapprochons chaque jour un peu plus de notre objectif : Des performances optimales en compétition et un sentiment de sécurité dans toutes les situations.

L'expérience du sport professionnel est intégrée dans le développement des produits et permet d'amener des produits de valeur pour les athlètes amateurs au stade de la production en série.

Nous nous concentrons sur un large éventail d'athlètes et de disciplines différentes.



Route



VTT





Cross Country



Triathlon



Handisport



SYSTÈME QUIN D'ABUS DÉTECTION DES COLLISIONS

Seul sur votre vélo au milieu d'un paysage fascinant, en explorant les sentiers ou en dévalant la montagne sur des single trails étroits. Une expérience unique qui requiert des compétences techniques, une concentration maximale et une bonne endurance. Mais même si tout cela est vrai, une chute n'est pas exclue.

Si une situation d'urgence se produit, l'aide est nécessaire immédiatement. Grâce au système ABUS QUIN, le casque de vélo devient un partenaire à la rescousse.

QUIN est le centre d'appel d'urgence privé du casque. Par exemple, les casques ABUS QUIN sont dotés d'un accéléromètre intégré qui détecte et mesure les chutes. En cas de chute, le système avertit une personne préalablement définie et lui transmet la localisation de la victime via le tracking.

Cette personne peut alors coordonner l'aide à la personne victime d'une chute. Mais les situations d'urgence ne se limitent pas aux chutes.

LA DÉTECTION DE CHUTE - VOICI COMMENT ELLE FONCTIONNE



QUIN s'active automatiquement dès que le casque est déplacé. Pendant la conduite, la puce QUIN mesure en permanence les mouvements du casque.



En cas de chute ou d'accident, la détection de collision déclenche l'alerte d'urgence sur votre smartphone via le signal Bluetooth. Vous avez suffisamment de temps pour réagir.



Une aide rapide peut également être souhaitée en cas d'autres dangers ou de panne. C'est pourquoi le système ABUS QUIN peut également être déclenché manuellement.

Les casques ABUS QUIN n'offrent pas seulement une excellente protection, ils sont un compagnon protecteur ! Alors, ne vous privez plus jamais d'un casque - ABUS QUIN : NE ROULEZ PLUS JAMAIS SEUL !

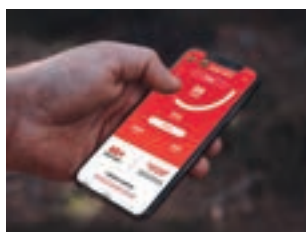

Si l'accident est marginal, l'alerte d'urgence peut être arrêtée et désactivée manuellement via l'application QUIN.



Si ce n'est pas le cas, un message est envoyé par SMS, e-mail ou notification push incluant les coordonnées GPS aux contacts d'urgence afin de coordonner les secours.

BALISE SOS - L'ALARME MANUELLE

Indépendamment de la détection de collision, l'alarme peut également être déclenchée manuellement dans toute situation dangereuse. Il suffit de taper quatre fois sur le côté du casque - et l'alerte d'urgence suit son cours.

POUR PLUS D'INFORMATIONS :
[ABUS.COM/QUIN](https://www.abus.com/quinn)



LA PUCE QUIN

Le cœur du système QUIN est la puce QUIN.

Elle utilise un algorithme complexe qui mesure et évalue en permanence des facteurs tels que l'impact, les changements de vitesse, les chocs, les changements inertiels rotatifs et linéaires.

BATTERIE RECHARGEABLE

Mode de charge rapide en quatre heures via micro USB et autonomie de la batterie pouvant atteindre un mois.

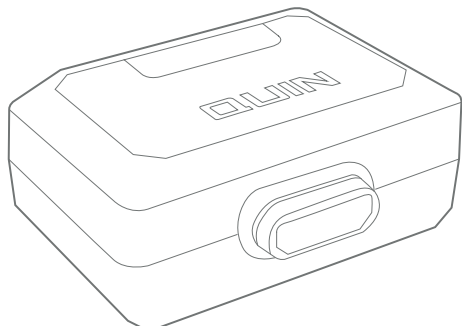

CAPTEURS DE CHOCS

Cinq capteurs de contrôle évaluent en permanence les données pendant l'utilisation et détectent les situations de collision.

RAISE TO WAKE

Appairage automatique du casque QUIN avec le smartphone dès que la puce QUIN détecte un mouvement.

BLUETOOTH 5.0

Portée sans fil garantie de 20 mètres, pour assurer une connexion stable avec le smartphone.

L'APPLICATION

L'application QUIN - pour iOS et Android - est l'interface entre le casque et son utilisateur, qui l'utilise pour contrôler toutes les fonctions du système ABUS QUIN.

Ici, par exemple, vous définissez les contacts qui seront notifiés en cas d'urgence.



REMARQUE

Un enregistrement gratuit est nécessaire pour utiliser l'application Quin for ABUS. Des services supplémentaires avec des coûts peuvent être ajoutés ou annulés à tout moment.



Un enregistrement gratuit est nécessaire pour utiliser l'application Quin for ABUS. Des services supplémentaires avec des coûts peuvent être ajoutés ou annulés à tout moment.



QUIN READY

Pensez à regarder sur le côté de vos casques si ceux-ci ont le symbole QUIN. Certains casques disposent de l'emplacement prévu pour la puce QUIN, qui est disponible séparément et peut être commandée et montée directement par vos clients.

ROUTE



AIRBREAKER



metallic copper

Page 182



white red

Page 182



velvet black

Page 182



steel blue

Page 182



silver white

Page 182



shiny black

Page 182



race grey

Page 182



polar white

Page 182



neon yellow

Page 182



gleam silver

Page 182



flip flop purple

Page 182



dark grey

Page 182



blaze red

Page 182



black red

Page 182



black gold

Page 182

Movistar
Team 22

Page 182

champagne
gold

Page 182

GAMECHANGER TT

Movistar
Team 22

Page 184



shiny black

Page 184



shiny white

Page 184



blaze red

Page 184



flip flop purple

Page 184

champagne
gold

Page 184

GAMECHANGER TRI



blaze red

Page 186



shiny white

Page 186



shiny black

Page 186



flip flop purple

Page 186

champagne
gold

Page 186

GAMECHANGER

champagne
gold

Page 188



white red

Page 188



velvet black

Page 188



steel blue

Page 188



silver white

Page 188



shiny black

Page 188

GAMECHANGER



race grey

Page 188



polar white

Page 188



neon yellow

Page 188



dark grey

Page 188



black red

Page 188



black gold

Page 188



blaze red

Page 188



gleam silver

Page 188



flip flop purple

Page 188



metallic copper

Page 188



Movistar
Team 22

Page 188

STORMCHASER



race grey

Page 190



metallic copper

Page 190



champagne
gold

Page 190



titan

Page 190



tech orange

Page 190



steel blue

Page 190



shiny black

Page 190



race white

Page 190



polar white

Page 190



pastel rose

Page 190



pastel blue

Page 190



neon yellow

Page 190



zigzag blue

Page 190



zigzag grey

Page 190



flip flop purple

Page 190



bloodmoon red

Page 190



blaze red

Page 190



midnight blue

Page 190



gleam silver

Page 190



velvet black

Page 190



Movistar
Team

Page 190

POWERDOME ACE



moss green

Page 192



race grey

Page 192



metallic copper

Page 192

POWERDOME



goldfish orange

Page 194



blaze red

Page 194



flip flop purple

Page 194



shiny black

Page 194



shiny white

Page 194



titan

Page 194



velvet black

Page 194



blaze red

Page 194



velvet black

Page 194



goldfish orange

Page 194



shiny black

Page 194



titan

Page 194



shiny white

Page 194



flip flop purple

Page 194

AVENTOR QUIN



neon yellow

Page 196



velvet black

Page 196



polar white

Page 196

VIAANTOR



steel blue

Page 198



blaze red

Page 198



dark grey

Page 198



gleam silver

Page 198



polar white

Page 198



racing red

Page 198

VIAUTOR



velvet black

Page 198



neon yellow

Page 198



polar white

Page 198



velvet black

Page 198



polar white

Page 198



neon yellow

Page 198



velvet black

Page 198

MACATOR



titan shiny

Page 200



white silver

Page 200



velvet black

Page 200



steel blue

Page 200



signal yellow

Page 200



shiny rose

Page 200



race grey

Page 200



pearl white

Page 200



midnight blue

Page 200



gleam silver

Page 200



bordeaux red

Page 200



blaze red

Page 200



matt black

Page 200



matt blue

Page 200



matt titan

Page 200



velvet black

Page 200



signal yellow

Page 200



polar white

Page 200



pearl white

Page 200



shiny black

Page 200



AIRBREAKER

VUES



metallic copper



metallic copper



CARACTÉRISTIQUES



Zoom Ace



Boucle



FlowStraps



AirPort



ACCESSOIRES

- Housse ABUS
- Housse ABUS Sportiv
- Casquette

TECHNOLOGIE



VARIANTES



white red



velvet black



steel blue



silver white



shiny black



race grey



polar white



neon yellow



gleam silver



flip flop purple



dark grey



blaze red



black red



black gold



Movistar Team 22



champagne gold



Article	EAN 4003318	couleur	Finition	Poids g	Taille	Tour de tête cm	Unité emb.
AirBreaker	86835 1	white red	shiny	200	S	51 - 55	1
AirBreaker	86836 8	white red	shiny	210	M	52 - 58	1
AirBreaker	86837 5	white red	shiny	230	L	59 - 61	1
AirBreaker	81719 9	velvet black	matt	200	S	51 - 55	1
AirBreaker	81720 5	velvet black	matt	210	M	52 - 58	1
AirBreaker	81721 2	velvet black	matt	230	L	59 - 61	1
AirBreaker	81722 9	steel blue	matt	200	S	51 - 55	1
AirBreaker	81723 6	steel blue	matt	210	M	52 - 58	1
AirBreaker	81724 3	steel blue	matt	230	L	59 - 61	1
AirBreaker	40281 4	silver white	shiny	200	S	51 - 55	1
AirBreaker	40282 1	silver white	shiny	210	M	52 - 58	1
AirBreaker	40283 8	silver white	shiny	230	L	59 - 61	1
AirBreaker	40275 3	shiny black	shiny	200	S	51 - 55	1
AirBreaker	40276 0	shiny black	shiny	210	M	52 - 58	1
AirBreaker	40277 7	shiny black	shiny	230	L	59 - 61	1
AirBreaker	40278 4	race grey	shiny	200	S	51 - 55	1
AirBreaker	40279 1	race grey	shiny	210	M	52 - 58	1
AirBreaker	40280 7	race grey	shiny	230	L	59 - 61	1
AirBreaker	81731 1	polar white	shiny	200	S	51 - 55	1
AirBreaker	81732 8	polar white	shiny	210	M	52 - 58	1
AirBreaker	81733 5	polar white	shiny	230	L	59 - 61	1
AirBreaker	81737 3	neon yellow	shiny	200	S	51 - 55	1
AirBreaker	81738 0	neon yellow	shiny	210	M	52 - 58	1
AirBreaker	81739 7	neon yellow	shiny	230	L	59 - 61	1
AirBreaker	81740 3	gleam silver	matt	200	S	51 - 55	1
AirBreaker	81741 0	gleam silver	matt	210	M	52 - 58	1
AirBreaker	81742 7	gleam silver	matt	230	L	59 - 61	1
AirBreaker	87512 0	flip flop purple	shiny	200	S	51 - 55	1
AirBreaker	87513 7	flip flop purple	shiny	210	M	52 - 58	1
AirBreaker	87514 4	flip flop purple	shiny	230	L	59 - 61	1
AirBreaker	86844 3	dark grey	shiny	200	S	51 - 55	1
AirBreaker	86845 0	dark grey	shiny	210	M	52 - 58	1
AirBreaker	86846 7	dark grey	shiny	230	L	59 - 61	1
AirBreaker	81734 2	blaze red	shiny	200	S	51 - 55	1
AirBreaker	81735 9	blaze red	shiny	210	M	52 - 58	1
AirBreaker	81736 6	blaze red	shiny	230	L	59 - 61	1
AirBreaker	86832 0	black red	matt	200	S	51 - 55	1
AirBreaker	86833 7	black red	matt	210	M	52 - 58	1
AirBreaker	86834 4	black red	matt	230	L	59 - 61	1
AirBreaker	86829 0	black gold	matt	200	S	51 - 55	1
AirBreaker	86830 6	black gold	matt	210	M	52 - 58	1
AirBreaker	86831 3	black gold	matt	230	L	59 - 61	1
AirBreaker	95089 6	Movistar Team	shiny	200	S	51 - 55	1
AirBreaker	95090 2	Movistar Team	shiny	210	M	52 - 58	1
AirBreaker	95091 9	Movistar Team	shiny	230	L	59 - 61	1
AirBreaker	62092 8	champagne gold	shiny	200	S	51 - 55	1
AirBreaker	62093 5	champagne gold	shiny	210	M	52 - 58	1
AirBreaker	62096 6	champagne gold	shiny	230	L	59 - 61	1
AirBreaker	61481 1	metallic copper	shiny	200	S	51 - 55	1
AirBreaker	61828 4	metallic copper	shiny	210	M	52 - 58	1
AirBreaker	61829 1	metallic copper	shiny	230	L	59 - 61	1



GAMECHANGER TT

NEW

VUES



Movistar Team 22



Movistar Team 22



CARACTÉRISTIQUES



Zoom Ace



Fidlock



FlowStraps



 visière magnétique

ACCESSOIRES

- Housse ABUS Sportiv
- Visière

TECHNOLOGIE



VARIANTES



shiny black



shiny white



blaze red 



flip flop purple 



champagne gold 

Article	EAN 4003318	couleur	Finition	Poids g	Taille	Tour de tête cm	Unité emb.
GameChanger TT	87885 5	shiny black	shiny	370	S	51 - 55	1
GameChanger TT	87886 2	shiny black	shiny	390	M	52 - 58	1
GameChanger TT	87887 9	shiny black	shiny	430	L	58 - 61	1
GameChanger TT	87888 6	shiny white	shiny	370	S	51 - 55	1
GameChanger TT	87889 3	shiny white	shiny	390	M	52 - 58	1
GameChanger TT	87890 9	shiny white	shiny	430	L	58 - 61	1
GameChanger TRI	64177 0	blaze red	shiny	370	S	51 - 55	1
GameChanger TRI	64178 7	blaze red	shiny	390	M	52 - 58	1
GameChanger TRI	64180 0	blaze red	shiny	430	L	58 - 61	1
GameChanger TRI	64182 4	flip flop purple	shiny	370	S	51 - 55	1
GameChanger TRI	64185 5	flip flop purple	shiny	390	M	52 - 58	1
GameChanger TRI	64186 2	flip flop purple	shiny	430	L	58 - 61	1
GameChanger TRI	64174 9	champagne gold	shiny	370	S	51 - 55	1
GameChanger TRI	64175 6	champagne gold	shiny	390	M	52 - 58	1
GameChanger TRI	64176 3	champagne gold	shiny	430	L	58 - 61	1
GameChanger TRI	95095 7	Movistar Team 22	shiny	370	S	51 - 55	1
GameChanger TRI	95096 4	Movistar Team 22	shiny	390	M	52 - 58	1
GameChanger TRI	95097 1	Movistar Team 22	shiny	430	L	58 - 61	1
Accessoires Glas Game-Changer TT/Tri	67936 0	clear			S		1
Accessoires Glas Game-Changer TT/Tri	67937 7	clear			M		1
Accessoires Glas Game-Changer TT/Tri	67938 4	clear			L		1
Accessoires Glas Game-Changer TT/Tri	67939 1	smoke			S		1
Accessoires Glas Game-Changer TT/Tri	67940 7	smoke			M		1
Accessoires Glas Game-Changer TT/Tri	67941 4	smoke			L		1
Accessoires Glas Game-Changer TT/Tri	67942 1	chrome			S		1
Accessoires Glas Game-Changer TT/Tri	67943 8	chrome			M		1
Accessoires Glas Game-Changer TT/Tri	67944 5	chrome			L		1



GAMECHANGER TRI

VUES



blaze red



blaze red



CARACTÉRISTIQUES



Zoom Ace



Fidlock



FlowStraps



AirPort



visière magnétique

ACCESSOIRES

- Housse ABUS Sportiv
- Visière

TECHNOLOGIE



VARIANTES



shiny white

shiny black

flip flop purple

champagne gold



Article	EAN 4003318	couleur	Finition	Poids g	Taille	Tour de tête cm	Unité emb.
GameChanger TRI	64275 3	shiny white	shiny	310	S	51 - 55	1
GameChanger TRI	64276 0	shiny white	shiny	320	M	52 - 58	1
GameChanger TRI	64278 4	shiny white	shiny	360	L	58 - 61	1
GameChanger TRI	64271 5	shiny black	shiny	310	S	51 - 55	1
GameChanger TRI	64272 2	shiny black	shiny	320	M	52 - 58	1
GameChanger TRI	64273 9	shiny black	shiny	360	L	58 - 61	1
GameChanger TRI	64268 5	flip flop purple	shiny	310	S	51 - 55	1
GameChanger TRI	64269 2	flip flop purple	shiny	320	M	52 - 58	1
GameChanger TRI	64270 8	flip flop purple	shiny	360	L	58 - 61	1
GameChanger TRI	64189 3	champagne gold	shiny	310	S	51 - 55	1
GameChanger TRI	64277 7	champagne gold	shiny	320	M	52 - 58	1
GameChanger TRI	64279 1	champagne gold	shiny	360	L	58 - 61	1
GameChanger TRI	64280 7	blaze red	shiny	310	S	51 - 55	1
GameChanger TRI	64281 4	blaze red	shiny	320	M	52 - 58	1
GameChanger TRI	64282 1	blaze red	shiny	360	L	58 - 61	1
Accessoires Glas Game- Changer TT/Tri	67936 0	clear			S		1
Accessoires Glas Game- Changer TT/Tri	67937 7	clear			M		1
Accessoires Glas Game- Changer TT/Tri	67938 4	clear			L		1
Accessoires Glas Game- Changer TT/Tri	67939 1	smoke			S		1
Accessoires Glas Game- Changer TT/Tri	67940 7	smoke			M		1
Accessoires Glas Game- Changer TT/Tri	67941 4	smoke			L		1
Accessoires Glas Game- Changer TT/Tri	67942 1	chrome			S		1
Accessoires Glas Game- Changer TT/Tri	67943 8	chrome			M		1
Accessoires Glas Game- Changer TT/Tri	67944 5	chrome			L		1



GAMECHANGER

NEW

VUES



champagne gold



champagne gold



CARACTÉRISTIQUES



Zoom Ace



Boucle



FlowStraps



AirPort

ACCESSOIRES

- Housse ABUS
- Housse ABUS Sportiv
- Casquette

TECHNOLOGIE



VARIANTES



white red



velvet black



steel blue



silver white



shiny black



race grey



polar white



neon yellow



dark grey



black red



black gold



blaze red



gleam silver



flip flop purple



metallic copper



Movistar Team 22

Article	EAN 4003318	couleur	Finition	Poids g	Taille	Tour de tête cm	Unité emb.
GameChanger	86788 0	white red	shiny	260	S	51 - 55	1
GameChanger	86789 7	white red	shiny	270	M	52 - 58	1
GameChanger	86790 3	white red	shiny	290	L	59 - 62	1
GameChanger	77591 8	velvet black	matt	260	S	51 - 55	1
GameChanger	77592 5	velvet black	matt	270	M	52 - 58	1
GameChanger	77593 2	velvet black	matt	290	L	59 - 62	1
GameChanger	77606 9	steel blue	matt	260	S	51 - 55	1
GameChanger	77607 6	steel blue	matt	270	M	52 - 58	1
GameChanger	77608 3	steel blue	matt	290	L	59 - 62	1
GameChanger	40272 2	silver white	shiny	260	S	51 - 55	1
GameChanger	40273 9	silver white	shiny	270	M	52 - 58	1
GameChanger	40274 6	silver white	shiny	290	L	59 - 62	1
GameChanger	40266 1	shiny black	shiny	260	S	51 - 55	1
GameChanger	40267 8	shiny black	shiny	270	M	52 - 58	1
GameChanger	40268 5	shiny black	shiny	290	L	59 - 62	1
GameChanger	40269 2	race grey	shiny	260	S	51 - 55	1
GameChanger	40270 8	race grey	shiny	270	M	52 - 58	1
GameChanger	40271 5	race grey	shiny	290	L	59 - 62	1
GameChanger	77600 7	polar white	shiny	260	S	51 - 55	1
GameChanger	77601 4	polar white	shiny	270	M	52 - 58	1
GameChanger	77602 1	polar white	shiny	290	L	59 - 62	1
GameChanger	77810 0	neon yellow	shiny	260	S	51 - 55	1
GameChanger	77811 7	neon yellow	shiny	270	M	52 - 58	1
GameChanger	77812 4	neon yellow	shiny	290	L	59 - 62	1
GameChanger	86823 8	dark grey	shiny	260	S	51 - 55	1
GameChanger	86824 5	dark grey	shiny	270	M	52 - 58	1
GameChanger	86825 2	dark grey	shiny	290	L	59 - 62	1
GameChanger	86785 9	black red	matt	260	S	51 - 55	1
GameChanger	86786 6	black red	matt	270	M	52 - 58	1
GameChanger	86787 3	black red	matt	290	L	59 - 62	1
GameChanger	86784 2	black gold	matt	260	S	51 - 55	1
GameChanger	86783 5	black gold	matt	270	M	52 - 58	1
GameChanger	86759 0	black gold	matt	290	L	59 - 62	1
GameChanger	77603 8	blaze red	shiny	260	S	51 - 55	1
GameChanger	77604 5	blaze red	shiny	270	M	52 - 58	1
GameChanger	77605 2	blaze red	shiny	290	L	59 - 62	1
GameChanger	81664 2	gleam silver	matt	260	S	51 - 55	1
GameChanger	81665 9	gleam silver	matt	270	M	52 - 58	1
GameChanger	81666 6	gleam silver	matt	290	L	59 - 62	1
GameChanger	84754 7	flip flop purple	shiny	260	S	51 - 55	1
GameChanger	84755 4	flip flop purple	shiny	270	M	52 - 58	1
GameChanger	84756 1	flip flop purple	shiny	290	L	59 - 62	1
GameChanger	62101 7	metallic copper	shiny	260	S	51 - 55	1
GameChanger	63269 3	metallic copper	shiny	270	M	52 - 58	1
GameChanger	63270 9	metallic copper	shiny	290	L	59 - 62	1
GameChanger	63839 8	champagne gold	shiny	260	S	51 - 55	1
GameChanger	63840 4	champagne gold	shiny	270	M	52 - 58	1
GameChanger	64024 7	champagne gold	shiny	290	L	59 - 62	1
GameChanger	95092 6	Movistar Team 22	shiny	260	S	51 - 55	1
GameChanger	95093 3	Movistar Team 22	shiny	270	M	52 - 58	1
GameChanger	95094 0	Movistar Team 22	shiny	290	L	59 - 62	1



STORMCHASER

NEW

VUES



race grey



race grey



CARACTÉRISTIQUES



Zoom Ace



Boucle



AirPort

ACCESSOIRES

- Housse ABUS
- Housse ABUS Sportiv
- Casquette

TECHNOLOGIE



VARIANTES



metallic copper



champagne gold



titan



tech orange



steel blue



shiny black



race white



polar white



pastel rose



pastel blue



neon yellow



zigzag blue



zigzag grey



flipflop purple



bloodmoon red



blaze red



midnight blue



gleam silver



velvet black



Movistar Team

Article	EAN 4003318	couleur	Finition	Poids g	Taille	Tour de tête cm	Unité emb.
StormChaser	05337 5	metallic copper	shiny	200	S	51 - 55	1
StormChaser	05533 1	metallic copper	shiny	220	M	54 - 58	1
StormChaser	20727 3	metallic copper	shiny	240	L	57 - 61	1
StormChaser	38855 2	champagne gold	shiny	200	S	51 - 55	1
StormChaser	39910 7	champagne gold	shiny	220	M	54 - 58	1
StormChaser	40883 0	champagne gold	shiny	240	L	57 - 61	1
StormChaser	87197 9	titan	shiny	200	S	51 - 55	1
StormChaser	87198 6	titan	shiny	220	M	54 - 58	1
StormChaser	87199 3	titan	shiny	240	L	59 - 61	1
StormChaser	40361 3	titan	shiny	280	XL	61 - 63	1
StormChaser	67739 7	tech orange	shiny	200	S	51 - 55	1
StormChaser	67740 3	tech orange	shiny	220	M	54 - 58	1
StormChaser	67741 0	tech orange	shiny	240	L	59 - 61	1
StormChaser	87200 6	steel blue	shiny	200	S	51 - 55	1
StormChaser	87201 3	steel blue	shiny	220	M	54 - 58	1
StormChaser	87202 0	steel blue	shiny	240	L	59 - 61	1
StormChaser	40364 4	steel blue	shiny	280	XL	61 - 63	1
StormChaser	63375 1	shiny black	shiny	200	S	51 - 55	1
StormChaser	63376 8	shiny black	shiny	220	M	54 - 58	1
StormChaser	63377 5	shiny black	shiny	240	L	59 - 61	1
StormChaser	63409 3	shiny black	shiny	280	XL	61 - 63	1
StormChaser	67736 6	race white	shiny	200	S	51 - 55	1
StormChaser	67737 3	race white	shiny	220	M	54 - 58	1
StormChaser	67738 0	race white	shiny	240	L	59 - 61	1
StormChaser	87185 6	polar white	shiny	200	S	51 - 55	1
StormChaser	87186 3	polar white	shiny	220	M	54 - 58	1
StormChaser	87187 0	polar white	shiny	240	L	59 - 61	1
StormChaser	40362 0	polar white	shiny	280	XL	61 - 63	1
StormChaser	67724 3	pastel rose	shiny	200	S	51 - 55	1
StormChaser	67725 0	pastel rose	shiny	220	M	54 - 58	1
StormChaser	67726 7	pastel rose	shiny	240	L	59 - 61	1
StormChaser	67727 4	pastel blue	shiny	200	S	51 - 55	1
StormChaser	67728 1	pastel blue	shiny	220	M	54 - 58	1
StormChaser	67729 8	pastel blue	shiny	240	L	59 - 61	1
StormChaser	87188 7	neon yellow	shiny	200	S	51 - 55	1
StormChaser	87189 4	neon yellow	shiny	220	M	54 - 58	1
StormChaser	87190 0	neon yellow	shiny	240	L	59 - 61	1
StormChaser	67733 5	zigzag grey	shiny	200	S	51 - 55	1
StormChaser	67734 2	zigzag grey	shiny	220	M	54 - 58	1
StormChaser	67735 9	zigzag grey	shiny	240	L	59 - 61	1
StormChaser	67730 4	zigzag blue	shiny	200	S	51 - 55	1
StormChaser	67731 1	zigzag blue	shiny	220	M	54 - 58	1
StormChaser	67732 8	zigzag blue	shiny	240	L	59 - 61	1
StormChaser	40358 3	flipflop purple	shiny	200	S	51 - 55	1
StormChaser	40359 0	flipflop purple	shiny	220	M	54 - 58	1
StormChaser	40360 6	flipflop purple	shiny	240	L	59 - 61	1
StormChaser	63408 6	flipflop purple	shiny	280	XL	61 - 63	1
StormChaser	67718 2	bloodmoon red	matt	200	S	51 - 55	1
StormChaser	67719 9	bloodmoon red	matt	220	M	54 - 58	1
StormChaser	67720 5	bloodmoon red	matt	240	L	59 - 61	1
StormChaser	87203 7	blaze red	shiny	200	S	51 - 55	1
StormChaser	87204 4	blaze red	shiny	220	M	54 - 58	1
StormChaser	87205 1	blaze red	shiny	240	L	59 - 61	1
StormChaser	40363 7	blaze red	shiny	280	XL	61 - 63	1
StormChaser	67721 2	midnight blue	matt	200	S	51 - 55	1
StormChaser	67722 9	midnight blue	matt	220	M	54 - 58	1
StormChaser	67723 6	midnight blue	matt	240	L	59 - 61	1
StormChaser	87191 7	gleam silver	shiny	200	S	51 - 55	1
StormChaser	87192 4	gleam silver	shiny	220	M	54 - 58	1
StormChaser	87193 1	gleam silver	shiny	240	L	59 - 61	1
StormChaser	87000 2	velvet black	matt	200	S	51 - 55	1
StormChaser	87001 9	velvet black	matt	220	M	54 - 58	1
StormChaser	87010 1	velvet black	matt	240	L	59 - 61	1
StormChaser	40303 3	velvet black	matt	240	XL	61 - 63	1
StormChaser	63120 7	Movistar Team	shiny	200	S	51 - 55	1
StormChaser	63121 4	Movistar Team	shiny	220	M	54 - 58	1
StormChaser	63122 1	Movistar Team	shiny	240	L	59 - 61	1

POWERDOME ACE

VUES



moss green



moss green



CARACTÉRISTIQUES



Zoom Ace



FlowStraps



Mousses flottantes

ACCESSOIRES

- Housse ABUS
- Casquette

TECHNOLOGIE



VARIANTES



race grey



metallic copper

Article	EAN 4003318	couleur	Finition	Poids g	Taille	Tour de tête cm	Unité emb.
PowerDome ACE	91970 1	race grey	shiny	210	S	51 - 55	1
PowerDome ACE	91971 8	race grey	shiny	230	M	54 - 58	1
PowerDome ACE	91972 5	race grey	shiny	250	L	57 - 61	1
PowerDome ACE	91976 3	metallic copper	matt	210	S	51 - 55	1
PowerDome ACE	91977 0	metallic copper	matt	230	M	54 - 58	1
PowerDome ACE	91978 7	metallic copper	matt	250	L	57 - 61	1
PowerDome ACE	91973 2	moss green	shiny	210	S	51 - 55	1
PowerDome ACE	91974 9	moss green	shiny	230	M	54 - 58	1
PowerDome ACE	91975 6	moss green	shiny	250	L	57 - 61	1



POWERDOME

NEW

VUES



goldfish orange



goldfish orange



CARACTÉRISTIQUES



Zoom Ace



FlowStraps



Mousses flottantes

ACCESSOIRES

- Housse ABUS
- Casquette

TECHNOLOGIE



VARIANTES



Article	EAN 4003318	couleur	Finition	Poids g	Taille	Tour de tête cm	Unité emb.
PowerDome	91943 5	blaze red	shiny	210	S	51 - 55	1
PowerDome	91944 2	blaze red	shiny	230	M	54 - 58	1
PowerDome	91945 9	blaze red	shiny	250	L	57 - 61	1
PowerDome	91946 6	flip flop purple	shiny	210	S	51 - 55	1
PowerDome	91947 3	flip flop purple	shiny	230	M	54 - 58	1
PowerDome	91948 0	flip flop purple	shiny	250	L	57 - 61	1
PowerDome	91940 4	goldfish orange	shiny	210	S	51 - 55	1
PowerDome	91941 1	goldfish orange	shiny	230	M	54 - 58	1
PowerDome	91942 8	goldfish orange	shiny	250	L	57 - 61	1
PowerDome	91923 7	shiny black	shiny	210	S	51 - 55	1
PowerDome	91924 4	shiny black	shiny	230	M	54 - 58	1
PowerDome	91925 1	shiny black	shiny	250	L	57 - 61	1
PowerDome	91929 9	shiny white	shiny	210	S	51 - 55	1
PowerDome	91930 5	shiny white	shiny	230	M	54 - 58	1
PowerDome	91934 3	shiny white	shiny	250	L	57 - 61	1
PowerDome	91926 8	titan	shiny	210	S	51 - 55	1
PowerDome	91927 5	titan	shiny	230	M	54 - 58	1
PowerDome	91928 2	titan	shiny	250	L	57 - 61	1
PowerDome	91920 6	velvet black	matt	210	S	51 - 55	1
PowerDome	91921 3	velvet black	matt	230	M	54 - 58	1
PowerDome	91922 0	velvet black	matt	250	L	57 - 61	1
PowerDome MIPS	91964 0	blaze red	shiny	240	S	51 - 55	1
PowerDome MIPS	91965 7	blaze red	shiny	260	M	54 - 58	1
PowerDome MIPS	91966 4	blaze red	shiny	280	L	57 - 61	1
PowerDome MIPS	91949 7	velvet black	matt	240	S	51 - 55	1
PowerDome MIPS	91950 3	velvet black	matt	260	M	54 - 58	1
PowerDome MIPS	91951 0	velvet black	matt	280	L	57 - 61	1
PowerDome MIPS	91961 9	goldfish orange	shiny	240	S	51 - 55	1
PowerDome MIPS	91962 6	goldfish orange	shiny	260	M	54 - 58	1
PowerDome MIPS	91963 3	goldfish orange	shiny	280	L	57 - 61	1
PowerDome MIPS	91952 7	shiny black	shiny	240	S	51 - 55	1
PowerDome MIPS	91953 4	shiny black	shiny	260	M	54 - 58	1
PowerDome MIPS	91954 1	shiny black	shiny	280	L	57 - 61	1
PowerDome MIPS	91955 8	titan	shiny	240	S	51 - 55	1
PowerDome MIPS	91956 5	titan	shiny	260	M	54 - 58	1
PowerDome MIPS	91957 2	titan	shiny	280	L	57 - 61	1
PowerDome MIPS	91958 9	shiny white	shiny	240	S	51 - 55	1
PowerDome MIPS	91959 6	shiny white	shiny	260	M	54 - 58	1
PowerDome MIPS	91960 2	shiny white	shiny	280	L	57 - 61	1
PowerDome MIPS	91967 1	flip flop purple	shiny	240	S	51 - 55	1
PowerDome MIPS	91968 8	flip flop purple	shiny	260	M	54 - 58	1
PowerDome MIPS	91969 5	flip flop purple	shiny	280	L	57 - 61	1



AVENTOR QUIN

VUES



neon yellow



neon yellow



CARACTÉRISTIQUES



Zoom Ace



Boucle

ACCESSOIRES

- Housse ABUS
- Casquette

TECHNOLOGIE



VARIANTES



velvet black



polar white

Article	EAN 4003318	couleur	Finition	Poids g	Taille	Tour de tête cm	Unité emb.
Aventor QUIN	87306 5	velvet black	shiny	260	M	54 - 58	1
Aventor QUIN	87307 2	velvet black	shiny	300	L	57 - 61	1
Aventor QUIN	87308 9	polar white	shiny	260	M	54 - 58	1
Aventor QUIN	87309 6	polar white	shiny	300	L	57 - 61	1
Aventor QUIN	88489 4	neon yellow	shiny	260	M	54 - 58	1
Aventor QUIN	88490 0	neon yellow	shiny	300	L	57 - 61	1



VIAUTOR

VUES



steel blue



steel blue



CARACTÉRISTIQUES



Zoom Ace



Boucle

ACCESSOIRES

- Housse ABUS
- Casquette

TECHNOLOGIE



VARIANTES



blaze red



dark grey



gleam silver



polar white



racing red



velvet black



neon yellow



polar white



velvet black



polar white



neon yellow



velvet black

Article	EAN 4003318	couleur	Finition	Poids g	Taille	Tour de tête cm	Unité emb.
Viantor	82672 6	blaze red	shiny	250	S	51 - 55	1
Viantor	78152 0	blaze red	shiny	270	M	52 - 58	1
Viantor	78151 3	blaze red	shiny	320	L	58 - 62	1
Viantor	40589 1	dark grey	shiny	250	S	51 - 55	1
Viantor	40590 7	dark grey	shiny	270	M	52 - 58	1
Viantor	40591 4	dark grey	shiny	320	L	58 - 62	1
Viantor	81676 5	gleam silver	matt	270	M	52 - 58	1
Viantor	81677 2	gleam silver	matt	320	L	58 - 62	1
Viantor	82678 8	polar white	matt	250	S	51 - 55	1
Viantor	78159 9	polar white	matt	270	M	52 - 58	1
Viantor	78160 5	polar white	matt	320	L	58 - 62	1
Viantor	40583 9	racing red	shiny	250	S	51 - 55	1
Viantor	40584 6	racing red	shiny	270	M	52 - 58	1
Viantor	40585 3	racing red	shiny	320	L	58 - 62	1
Viantor	78161 2	steel blue	matt	270	M	52 - 58	1
Viantor	78162 9	steel blue	matt	320	L	58 - 62	1
Viantor	82681 8	velvet black	matt	250	S	51 - 55	1
Viantor	78153 7	velvet black	matt	270	M	52 - 58	1
Viantor	78154 4	velvet black	matt	320	L	58 - 62	1
Viantor MIPS	89216 5	neon yellow	shiny	250	S	51 - 55	1
Viantor MIPS	89215 8	neon yellow	shiny	290	M	52 - 58	1
Viantor MIPS	89214 1	neon yellow	shiny	340	L	58 - 62	1
Viantor MIPS	89213 4	polar white	matt	250	S	51 - 55	1
Viantor MIPS	89212 7	polar white	matt	290	M	52 - 58	1
Viantor MIPS	89211 0	polar white	matt	340	L	58 - 62	1
Viantor MIPS	89210 3	velvet black	matt	250	S	51 - 55	1
Viantor MIPS	89209 7	velvet black	matt	290	M	52 - 58	1
Viantor MIPS	89208 0	velvet black	matt	340	L	58 - 62	1
Viantor QUIN	88497 9	polar white	shiny	280	M	54 - 58	1
Viantor QUIN	88498 6	polar white	shiny	310	L	57 - 61	1
Viantor QUIN	88500 6	neon yellow	shiny	280	M	54 - 58	1
Viantor QUIN	88501 3	neon yellow	shiny	310	L	57 - 61	1
Viantor QUIN	88494 8	velvet black	shiny	280	M	54 - 58	1
Viantor QUIN	88495 5	velvet black	shiny	310	L	57 - 61	1



MACATOR

NEW

VUES



titan shiny



titan shiny



CARACTÉRISTIQUES



Zoom Ace



Boucle

ACCESSOIRES

- Housse ABUS
- Casquette

VISIÈRE
INCLUDE

TECHNOLOGIE



VARIANTES



Article	EAN 4003318	couleur	Finition	Poids g	Taille	Tour de tête cm	Unité emb.
Macator	87232 7	white silver	shiny	280	S	51 - 55	1
Macator	87233 4	white silver	shiny	300	M	52 - 58	1
Macator	87234 1	white silver	shiny	360	L	58 - 62	1
Macator	87214 3	velvet black	shiny	280	S	51 - 55	1
Macator	87212 9	velvet black	shiny	300	M	52 - 58	1
Macator	87213 6	velvet black	shiny	360	L	58 - 62	1
Macator	87215 0	titan shiny	shiny	280	S	51 - 55	1
Macator	87216 7	titan shiny	shiny	300	M	52 - 58	1
Macator	87217 4	titan shiny	shiny	360	L	58 - 62	1
Macator	87242 6	steel blue	shiny	280	S	51 - 55	1
Macator	87243 3	steel blue	shiny	300	M	52 - 58	1
Macator	87244 0	steel blue	shiny	360	L	58 - 62	1
Macator	87229 7	signal yellow	shiny	280	S	51 - 55	1
Macator	87230 3	signal yellow	shiny	300	M	52 - 58	1
Macator	87231 0	signal yellow	shiny	360	L	58 - 62	1
Macator	67334 4	shiny rose	shiny	280	S	51 - 55	1
Macator	67335 1	shiny rose	shiny	300	M	52 - 58	1
Macator	67336 8	shiny rose	shiny	360	L	58 - 62	1
Macator	67328 3	race grey	shiny	280	S	51 - 55	1
Macator	67329 0	race grey	shiny	300	M	52 - 58	1
Macator	67330 6	race grey	shiny	360	L	58 - 62	1
Macator	67331 3	pearl white	shiny	280	S	51 - 55	1
Macator	67332 0	pearl white	shiny	300	M	52 - 58	1
Macator	67333 7	pearl white	shiny	360	L	58 - 62	1
Macator	67325 2	midnight blue	shiny	280	S	51 - 55	1
Macator	67326 9	midnight blue	shiny	300	M	52 - 58	1
Macator	67327 6	midnight blue	shiny	360	L	58 - 62	1
Macator	87218 1	gleam silver	shiny	280	S	51 - 55	1
Macator	87219 8	gleam silver	shiny	300	M	52 - 58	1
Macator	87220 4	gleam silver	shiny	360	L	58 - 62	1
Macator	87235 8	bordeaux red	shiny	280	S	51 - 55	1
Macator	87237 2	bordeaux red	shiny	300	M	52 - 58	1
Macator	87238 9	bordeaux red	shiny	360	L	58 - 62	1
Macator	87221 1	blaze red	shiny	280	S	51 - 55	1
Macator	87222 8	blaze red	shiny	300	M	52 - 58	1
Macator	87223 5	blaze red	shiny	360	L	58 - 62	1
Macator	91183 5	matt black	matt	240	S	51 - 55	1
Macator	91184 2	matt black	matt	270	M	52 - 58	1
Macator	91185 9	matt black	matt	300	L	58 - 62	1
Macator	95591 4	matt blue	matt	240	S	51 - 55	1
Macator	95592 1	matt blue	matt	270	M	52 - 58	1
Macator	95593 8	matt blue	matt	300	L	58 - 62	1
Macator	95588 4	matt titan	matt	240	S	51 - 55	1
Macator	95589 1	matt titan	matt	270	M	52 - 58	1
Macator	95590 7	matt titan	matt	300	L	58 - 62	1
Macator MIPS	89217 2	velvet black	shiny	370	L	58 - 62	1
Macator MIPS	89218 9	velvet black	shiny	320	M	52 - 58	1
Macator MIPS	89219 6	velvet black	shiny	290	S	51 - 55	1
Macator MIPS	89220 2	signal yellow	shiny	370	L	58 - 62	1
Macator MIPS	89221 9	signal yellow	shiny	320	M	52 - 58	1
Macator MIPS	89222 6	signal yellow	shiny	290	S	51 - 55	1
Macator MIPS	89223 3	polar white	matt	370	L	58 - 62	1
Macator MIPS	89224 0	polar white	matt	320	M	52 - 58	1
Macator MIPS	89225 7	polar white	matt	290	S	51 - 55	1
Macator MIPS	96148 9	pearl white	shiny	310	L	58 - 62	1
Macator MIPS	96147 2	pearl white	shiny	290	M	52 - 58	1
Macator MIPS	96146 5	pearl white	shiny	270	S	51 - 55	1
Macator MIPS	96149 6	shiny black	shiny	270	S	51 - 55	1
Macator MIPS	96150 2	shiny black	shiny	290	M	52 - 58	1
Macator MIPS	96151 9	shiny black	shiny	310	L	58 - 62	1

VTT



AIRDROP



Mips
concrete grey

Page 206

Mips
black gold

Page 206

Mips
polar white

Page 206

Mips
velvet black

Page 206

Mips
velvet black

Page 206

CLIFFHANGER



Ti silver

Page 208

concrete grey

Page 208

iced mint

Page 208

midnight blue

Page 208

pine green

Page 208

shiny white

Page 208



velvet black

Page 208

chalk grey

Page 208

wildberry red

Page 208

Mips
metallic copper

Page 208

Mips
concrete grey

Page 208

Mips
velvet black

Page 208



Mips
pine green

Page 208

Mips
shiny white

Page 208

Mips
iced mint

Page 208

Mips
velvet black

Page 208

Mips
shiny white

Page 208

MOVENTOR 2.0



wildberry red

Page 210

concrete grey

Page 210

iced mint

Page 210

midnight blue

Page 210

pine green

Page 210

shiny white

Page 210



chalk grey

Page 210

Ti silver

Page 210

MOVENTOR 2.0



velvet black

Page 210

metallic copper

Page 210

concrete grey

Page 210

iced mint

Page 210

pine green

Page 210

shiny white

Page 210



velvet black

Page 210

shiny white

Page 210

MODROP



chalk grey

Page 212

pine green

Page 212

velvet black

Page 212

concrete grey

Page 212

midnight blue

Page 212

dusky camel

Page 212



iced mint

Page 212

polar white

Page 212

wildberry red

Page 212

Ti silver

Page 212

metallic copper

Page 212

velvet black

Page 212



concrete grey

Page 212

shiny white

Page 212

pine green

Page 212

iced mint

Page 212

velvet black

Page 212

polar white

Page 212

MOTRIP



shiny white

Page 214

shiny black

Page 214

pine green

Page 214

midnight blue

Page 214

iced mint

Page 214

concrete grey

Page 214



MOTRIP

Mips



Mips



shiny black

shiny white

Page 214

Page 214



BUTEO

polar white

infra red

neon yellow

velvet black

Page 216

Page 216

Page 216

Page 216

AIRDROP

VUES



concrete grey



concrete grey



CARACTÉRISTIQUES



Zoom Ace FF



Visière amovible réglable en hauteur



Boucle double D



Protection des clavicules



Canal de son ambient

ACCESSOIRES

- Capteur Quin
- Masque Buteo

TECHNOLOGIE



VARIANTES



black gold

polar white

velvet black

velvet black

Article	EAN 4003318	couleur	Finition	Poids g	Taille	Tour de tête cm	Unité emb.
AirDrop MIPS	66254 6	black gold	matt	790	S M	52 - 58	1
AirDrop MIPS	66255 3	black gold	matt	890	L XL	58 - 62	1
AirDrop MIPS	66024 5	concrete grey	matt	790	S M	52 - 58	1
AirDrop MIPS	66026 9	concrete grey	matt	890	L XL	58 - 62	1
AirDrop MIPS	66022 1	polar white	matt	790	S M	52 - 58	1
AirDrop MIPS	66023 8	polar white	matt	890	L XL	58 - 62	1
AirDrop MIPS	65800 6	velvet black	matt	790	S M	52 - 58	1
AirDrop MIPS	66021 4	velvet black	matt	890	L XL	58 - 62	1
AirDrop MIPS QUIN	66287 4	velvet black	matt	795	S M	52 - 58	1
AirDrop MIPS QUIN	66288 1	velvet black	matt	895	L XL	58 - 62	1
Capteur Quin	68838 6						1



CLIFFHANGER

NEW

VUES



Ti silver



Ti silver



CARACTÉRISTIQUES



Zoom Ace MBT



Fidlock



TriVider



GoggFit



Visière réglable en hauteur

ACCESSOIRES

- Capteur Quin Slim

TECHNOLOGIE



VARIANTES



concrete grey

iced mint

midnight blue

pine green

shiny white

velvet black

chalk grey



wildberry red

metallic copper

concrete grey

velvet black

pine green

shiny white

iced mint



velvet black

shiny white

Article	EAN 4003318	couleur	Finition	Poids g	Taille	Tour de tête cm	Unité emb.
CliffHanger	65539 5	concrete grey	matt	300	S	51 - 55	1
CliffHanger	65540 1	concrete grey	matt	325	M	54 - 58	1
CliffHanger	65541 8	concrete grey	matt	365	L	57 - 61	1
CliffHanger	65537 1	iced mint	shiny	300	S	51 - 55	1
CliffHanger	65538 8	iced mint	shiny	325	M	54 - 58	1
CliffHanger	66695 7	iced mint	shiny	365	L	57 - 61	1
CliffHanger	65531 9	midnight blue	matt	300	S	51 - 55	1
CliffHanger	65532 6	midnight blue	matt	325	M	54 - 58	1
CliffHanger	65533 3	midnight blue	matt	365	L	57 - 61	1
CliffHanger	65534 0	pine green	matt	300	S	51 - 55	1
CliffHanger	65535 7	pine green	matt	325	M	54 - 58	1
CliffHanger	65536 4	pine green	matt	365	L	57 - 61	1
CliffHanger	65528 9	shiny white	shiny	300	S	51 - 55	1
CliffHanger	65529 6	shiny white	shiny	325	M	54 - 58	1
CliffHanger	65530 2	shiny white	shiny	365	L	57 - 61	1
CliffHanger	65525 8	velvet black	matt	300	S	51 - 55	1
CliffHanger	65526 5	velvet black	matt	325	M	54 - 58	1
CliffHanger	65527 2	velvet black	matt	365	L	57 - 61	1
CliffHanger	67242 2	Ti silver	matt	300	S	51 - 55	1
CliffHanger	67243 9	Ti silver	matt	325	M	54 - 58	1
CliffHanger	67244 6	Ti silver	matt	365	L	57 - 61	1
CliffHanger	66240 9	chalk grey	Matt	300	S	51 - 55	1
CliffHanger	66253 9	chalk grey	Matt	325	M	54 - 58	1
CliffHanger	67238 5	chalk grey	Matt	365	L	57 - 61	1
CliffHanger	67239 2	wildberry red	Matt	300	S	51 - 55	1
CliffHanger	67240 8	wildberry red	Matt	325	M	54 - 58	1
CliffHanger	67241 5	wildberry red	Matt	365	L	57 - 61	1
CliffHanger MIPS	65551 7	metallic copper	matt	330	S	51 - 55	1
CliffHanger MIPS	65552 4	metallic copper	matt	350	M	54 - 58	1
CliffHanger MIPS	65553 1	metallic copper	matt	390	L	57 - 61	1
CliffHanger MIPS	67248 4	pine green	matt	330	S	51 - 55	1
CliffHanger MIPS	67249 1	pine green	matt	350	M	54 - 58	1
CliffHanger MIPS	67306 1	pine green	matt	390	L	57 - 61	1
CliffHanger MIPS	67245 3	shiny white	shiny	330	S	51 - 55	1
CliffHanger MIPS	67246 0	shiny white	shiny	350	M	54 - 58	1
CliffHanger MIPS	67247 7	shiny white	shiny	390	L	57 - 61	1
CliffHanger MIPS	67310 8	iced mint	matt	330	S	51 - 55	1
CliffHanger MIPS	67507 2	iced mint	matt	350	M	54 - 58	1
CliffHanger MIPS	67508 9	iced mint	matt	390	L	57 - 61	1
CliffHanger MIPS	65554 8	concrete grey	matt	330	S	51 - 55	1
CliffHanger MIPS	66485 4	concrete grey	matt	350	M	54 - 58	1
CliffHanger MIPS	65555 5	concrete grey	matt	390	L	57 - 61	1
CliffHanger MIPS	65542 5	velvet black	matt	330	S	51 - 55	1
CliffHanger MIPS	65543 2	velvet black	matt	350	M	54 - 58	1
CliffHanger MIPS	65544 9	velvet black	matt	390	L	57 - 61	1
CliffHanger QUIN	65556 2	velvet black	matt	305	S	51 - 55	1
CliffHanger QUIN	65557 9	velvet black	matt	330	M	54 - 58	1
CliffHanger QUIN	65558 6	velvet black	matt	370	L	57 - 61	1
CliffHanger QUIN	65734 4	shiny white	shiny	305	S	51 - 55	1
CliffHanger QUIN	65737 5	shiny white	shiny	330	M	54 - 58	1
CliffHanger QUIN	65738 2	shiny white	shiny	370	L	57 - 61	1
Capteur Quin Slim	69319 9						1

VTT



MOVENTOR 2.0

NEW

VUES



wildberry red



wildberry red



CARACTÉRISTIQUES



Zoom Ace MTB



Boucle



GogFit



TriVider



Visière réglable en hauteur

ACCESSOIRES

- Housse ABUS
- Capteur Quin

TECHNOLOGIE



VARIANTES



concrete grey

iced mint

midnight blue

pine green

shiny white

chalk grey

Ti silver



velvet black

metallic copper

concrete grey

iced mint

pine green

shiny white

velvet black



shiny white

Article	EAN 4003318	couleur	Finition	Poids g	Taille	Tour de tête cm	Unité emb.
Moventor 2.0	65502 9	concrete grey	shiny	290	S	51 - 55	1
Moventor 2.0	65503 6	concrete grey	shiny	300	M	54 - 58	1
Moventor 2.0	65504 3	concrete grey	shiny	320	L	57 - 61	1
Moventor 2.0	65505 0	iced mint	shiny	290	S	51 - 55	1
Moventor 2.0	65506 7	iced mint	shiny	300	M	54 - 58	1
Moventor 2.0	65507 4	iced mint	shiny	320	L	57 - 61	1
Moventor 2.0	65496 1	midnight blue	shiny	290	S	51 - 55	1
Moventor 2.0	65497 8	midnight blue	shiny	300	M	54 - 58	1
Moventor 2.0	65498 5	midnight blue	shiny	320	L	57 - 61	1
Moventor 2.0	65499 2	pine green	shiny	290	S	51 - 55	1
Moventor 2.0	65500 5	pine green	shiny	300	M	54 - 58	1
Moventor 2.0	65501 2	pine green	shiny	320	L	57 - 61	1
Moventor 2.0	65493 0	shiny white	shiny	290	S	51 - 55	1
Moventor 2.0	65494 7	shiny white	shiny	300	M	54 - 58	1
Moventor 2.0	65495 4	shiny white	shiny	320	L	57 - 61	1
Moventor 2.0	65490 9	shiny white	matt	290	S	51 - 55	1
Moventor 2.0	65491 6	velvet black	matt	300	M	54 - 58	1
Moventor 2.0	65492 3	velvet black	matt	320	L	57 - 61	1
Moventor 2.0	74661 1	chalk grey	matt	290	S	51 - 55	1
Moventor 2.0	78600 6	chalk grey	matt	300	M	54 - 58	1
Moventor 2.0	83317 5	chalk grey	matt	320	L	57 - 61	1
Moventor 2.0	83318 2	wildberry red	matt	290	S	51 - 55	1
Moventor 2.0	83319 9	wildberry red	matt	300	M	54 - 58	1
Moventor 2.0	83320 5	wildberry red	matt	320	L	57 - 61	1
Moventor 2.0	83321 2	Ti silver	matt	290	S	51 - 55	1
Moventor 2.0	84127 9	Ti silver	matt	300	M	54 - 58	1
Moventor 2.0	84250 4	Ti silver	matt	320	L	57 - 61	1
Moventor 2.0 MIPS	65511 1	metallic copper	shiny	320	S	51 - 55	1
Moventor 2.0 MIPS	65512 8	metallic copper	shiny	330	M	54 - 58	1
Moventor 2.0 MIPS	65513 5	metallic copper	shiny	350	L	51 - 61	1
Moventor 2.0 MIPS	65508 1	velvet black	matt	320	S	51 - 55	1
Moventor 2.0 MIPS	65509 8	velvet black	matt	330	M	54 - 58	1
Moventor 2.0 MIPS	65510 4	velvet black	matt	350	L	57 - 61	1
Moventor 2.0 MIPS	65514 2	concrete grey	shiny	320	S	51 - 55	1
Moventor 2.0 MIPS	65515 9	concrete grey	shiny	330	M	54 - 58	1
Moventor 2.0 MIPS	65516 6	concrete grey	shiny	350	L	57 - 61	1
Moventor 2.0 MIPS	88487 0	iced mint	matt	320	S	51 - 55	1
Moventor 2.0 MIPS	88488 7	iced mint	matt	330	M	54 - 58	1
Moventor 2.0 MIPS	88493 1	iced mint	matt	350	L	57 - 61	1
Moventor 2.0 MIPS	87870 1	pine green	matt	320	S	51 - 55	1
Moventor 2.0 MIPS	88465 8	pine green	matt	330	M	54 - 58	1
Moventor 2.0 MIPS	88466 5	pine green	matt	350	L	57 - 61	1
Moventor 2.0 MIPS	84522 2	shiny white	shiny	320	S	51 - 55	1
Moventor 2.0 MIPS	84523 9	shiny white	shiny	330	M	54 - 58	1
Moventor 2.0 MIPS	85421 7	shiny white	shiny	350	L	57 - 61	1
Moventor 2.0 QUIN	65517 3	velvet black	matt	295	S	51 - 55	1
Moventor 2.0 QUIN	65518 0	velvet black	matt	305	M	54 - 58	1
Moventor 2.0 QUIN	65519 7	velvet black	matt	325	L	57 - 61	1
Moventor 2.0 QUIN	65520 3	shiny white	shiny	295	S	51 - 55	1
Moventor 2.0 QUIN	65521 0	shiny white	shiny	305	M	54 - 58	1
Moventor 2.0 QUIN	65522 7	shiny white	shiny	325	L	57 - 61	1
Capteur Quin	68838 6						1



MODROP

NEW

VUES



chalk grey



chalk grey



CARACTÉRISTIQUES



Zoom Ace MTB



Boucle



TriVider



GoggFit



Visière réglable en hauteur

ACCESSOIRES

- Housse ABUS
- Capteur Quin

TECHNOLOGIE



VARIANTES



pine green

velvet black

concrete grey

midnight blue

dusky camel

iced mint

polar white



wildberry red

Ti silver

metallic copper

velvet black

concrete grey

shiny white

pine green



iced mint

velvet black

polar white

Article	EAN 4003318	couleur	Finition	Poids g	Taille	Tour de tête cm	Unité emb.
MoDrop	64985 1	pine green	matt	310	S	51 - 55	1
MoDrop	64986 8	pine green	matt	330	M	54 - 58	1
MoDrop	64987 5	pine green	matt	360	L	57 - 61	1
MoDrop	64849 6	velvet black	matt	310	S	51 - 55	1
MoDrop	64851 9	velvet black	matt	330	M	54 - 58	1
MoDrop	64850 2	velvet black	matt	360	L	57 - 61	1
MoDrop	64852 6	concrete grey	matt	310	S	51 - 55	1
MoDrop	64853 3	concrete grey	matt	330	M	54 - 58	1
MoDrop	64854 0	concrete grey	matt	360	L	57 - 61	1
MoDrop	64861 8	midnight blue	matt	310	S	51 - 55	1
MoDrop	64863 2	midnight blue	matt	330	M	54 - 58	1
MoDrop	64871 7	midnight blue	matt	360	L	57 - 61	1
MoDrop	64857 1	dusky camel	matt	310	S	51 - 55	1
MoDrop	64858 8	dusky camel	matt	330	M	54 - 58	1
MoDrop	64859 5	dusky camel	matt	360	L	57 - 61	1
MoDrop	64988 2	iced mint	matt	310	S	51 - 55	1
MoDrop	64989 9	iced mint	matt	330	M	54 - 58	1
MoDrop	64990 5	iced mint	matt	360	L	57 - 61	1
MoDrop	66475 5	polar white	matt	310	S	51 - 55	1
MoDrop	66476 2	polar white	matt	330	M	54 - 58	1
MoDrop	66477 9	polar white	matt	360	L	57 - 61	1
MoDrop	67601 7	wildberry red	Matt	310	S	51 - 55	1
MoDrop	67612 3	wildberry red	Matt	330	M	54 - 58	1
MoDrop	68077 9	wildberry red	Matt	360	L	57 - 61	1
MoDrop	68981 9	Ti silver	Matt	310	S	51 - 55	1
MoDrop	69056 3	Ti silver	Matt	330	M	54 - 58	1
MoDrop	69079 2	Ti silver	Matt	360	L	57 - 61	1
MoDrop	67531 7	chalk grey	Matt	310	S	51 - 55	1
MoDrop	67585 0	chalk grey	Matt	330	M	54 - 58	1
MoDrop	67594 2	chalk grey	Matt	360	L	57 - 61	1
MoDrop MIPS	65739 9	velvet black	matt	340	S	51 - 55	1
MoDrop MIPS	65740 5	velvet black	matt	370	M	54 - 58	1
MoDrop MIPS	65741 2	velvet black	matt	390	L	57 - 61	1
MoDrop MIPS	65755 9	concrete grey	matt	340	S	51 - 55	1
MoDrop MIPS	65756 6	concrete grey	matt	370	M	54 - 58	1
MoDrop MIPS	65757 3	concrete grey	matt	390	L	57 - 61	1
MoDrop MIPS	65742 9	metallic copper	matt	340	S	51 - 55	1
MoDrop MIPS	65753 5	metallic copper	matt	370	M	54 - 58	1
MoDrop MIPS	65754 2	metallic copper	matt	390	L	57 - 61	1
MoDrop MIPS	69080 8	shiny white	shiny	340	S	51 - 55	1
MoDrop MIPS	69106 5	shiny white	shiny	370	M	54 - 58	1
MoDrop MIPS	69180 5	shiny white	shiny	390	L	57 - 61	1
MoDrop MIPS	69383 0	pine green	matt	340	S	51 - 55	1
MoDrop MIPS	69384 7	pine green	matt	370	M	54 - 58	1
MoDrop MIPS	72993 5	pine green	matt	390	L	57 - 61	1
MoDrop MIPS	72996 6	iced mint	matt	340	S	51 - 55	1
MoDrop MIPS	72997 3	iced mint	matt	370	M	54 - 58	1
MoDrop MIPS	72998 0	iced mint	matt	390	L	57 - 61	1
MoDrop QUIN	65797 9	polar white	matt	315	S	51 - 55	1
MoDrop QUIN	65798 6	polar white	matt	335	M	54 - 58	1
MoDrop QUIN	65799 3	polar white	matt	365	L	57 - 61	1
MoDrop QUIN	65758 0	velvet black	matt	315	S	51 - 55	1
MoDrop QUIN	65795 5	velvet black	matt	335	M	54 - 58	1
MoDrop QUIN	65796 2	velvet black	matt	365	L	57 - 61	1
Capteur Quin	68838 6						1



MOTRIP

NEW

VUES



shiny white



shiny white



CARACTÉRISTIQUES



Zoom Ace MTB



Boucle



GogFit



Visière réglable en hauteur

ACCESSOIRES

- Housse ABUS

TECHNOLOGIE



VARIANTES



shiny black



pine green



midnight blue



iced mint



concrete grey



Mips

shiny black



Mips

shiny white



Article	EAN 4003318	couleur	Finition	Poids g	Taille	Tour de tête cm	Unité emb.
MoTrip	64709 3	shiny white	shiny	320	S	51 - 55	1
MoTrip	64712 3	shiny white	shiny	340	M	54 - 58	1
MoTrip	64710 9	shiny white	shiny	350	L	57 - 61	1
MoTrip	64706 2	shiny black	shiny	320	S	51 - 55	1
MoTrip	64707 9	shiny black	shiny	340	M	54 - 58	1
MoTrip	64708 6	shiny black	shiny	350	L	57 - 61	1
MoTrip	64715 4	pine green	shiny	320	S	51 - 55	1
MoTrip	64720 8	pine green	shiny	340	M	54 - 58	1
MoTrip	64721 5	pine green	shiny	350	L	57 - 61	1
MoTrip	64711 6	midnight blue	shiny	320	S	51 - 55	1
MoTrip	64713 0	midnight blue	shiny	340	M	54 - 58	1
MoTrip	64714 7	midnight blue	shiny	350	L	57 - 61	1
MoTrip	64722 2	iced mint	shiny	320	S	51 - 55	1
MoTrip	64723 9	iced mint	shiny	340	M	54 - 58	1
MoTrip	66481 6	iced mint	shiny	350	L	57 - 61	1
MoTrip	64724 6	concrete grey	shiny	320	S	51 - 55	1
MoTrip	64754 3	concrete grey	shiny	340	M	54 - 58	1
MoTrip	64847 2	concrete grey	shiny	350	L	57 - 61	1
MoTrip MIPS	88496 2	shiny black	shiny	350	S	51 - 55	1
MoTrip MIPS	88499 3	shiny black	shiny	370	M	54 - 58	1
MoTrip MIPS	88508 2	shiny black	shiny	380	L	57 - 61	1
MoTrip MIPS	88821 2	shiny white	shiny	350	S	51 - 55	1
MoTrip MIPS	89177 9	shiny white	shiny	380	L	57 - 61	1
MoTrip MIPS	88977 6	shiny white	shiny	370	M	54 - 58	1

VTT



BUTEO



DONNÉES TECHNIQUES

- Revêtement anti-buée
- Elastique de 40 mm pour un ajustement sans glissement
- Couche de polaire pour un confort maximal
- Protège-nez pour un ajustement confortable et sûr
- Disponible avec des verres transparents et réfléchissants teintés

VARIANTES



infra red

neon yellow

velvet black

Article	EAN 4003318	couleur	Finition	Poids g	Taille	Unité emb.
Buteo infra red	68933 8	infra red		140	universal	1
Buteo neon yellow	68932 1	neon yellow		140	universal	1
Buteo polar white	68931 4	polar white		140	universal	1
Buteo velvet black	68930 7	velvet black		140	universal	1
Buteo Verre de rechange	68934 5	clear		15	universal	1
Buteo Verre de rechange	68935 2	smoky		15	universal	1
Buteo Verre de rechange	68936 9	red chrome		15	universal	1
Buteo Verre de rechange	68937 6	black chrome		15	universal	1



URBAIN



PEDELEC 2.0 ACE



champagne gold
Page 226



velvet black
Page 226



signal yellow
Page 226



pearl white
Page 226



midnight blue
Page 226



glacier blue
Page 226



race grey
Page 226



titan
Page 226



blaze red
Page 226



race grey
Page 228



velvet black
Page 228



signal yellow
Page 228



pearl white
Page 228



midnight blue
Page 228



glacier blue
Page 228



titan
Page 228



champagne gold
Page 228



blaze red
Page 228



velvet black
Page 228



signal yellow
Page 228



silver edition
Page 228



steel blue
Page 230



titan
Page 230



pearl white
Page 230



black edition
Page 230

PEDELEC 2.0

PEDELEC 1.1

HUD-Y ACE



velvet black

Page 232



shiny white

Page 232



goldfish orange

Page 232

HUD-Y



goldfish orange

Page 234



velvet black

Page 234



titan

Page 234



signal yellow

Page 234



race grey

Page 234



midnight blue

Page 234



flower white

Page 234



champagne gold

Page 234



shiny white

Page 234

URBAN-I 3.0 ACE



metallic copper

Page 236



velvet black

Page 236



goldfish orange

Page 236



polar white

Page 236

URBAN-I 3.0



monument grey

Page 238



velvet black

Page 238



titan

Page 238



street art

Page 238



polar white

Page 238



mellow mauve

Page 238

URBAN-1 3.0



living coral

Page 238



jade green

Page 238



glacier blue

Page 238



flower art

Page 238



core green

Page 238



core blue

Page 238



cannoli cream

Page 238



signal yellow

Page 238



signal silver

Page 238



signal orange

Page 238



velvet black

Page 238



titan

Page 238



signal yellow

Page 238

YOUN-1 ACE



metallic blue

Page 240



velvet black

Page 240



sparkling titan

Page 240



signal yellow

Page 240



rosé gold

Page 240



pearl white

Page 240



metallic silver

Page 240



metallic green

Page 240



glacier blue

Page 240



cherry red

Page 240

HYBAN 2.0 LED



signal glacier

Page 242



signal yellow

Page 242



signal silver

Page 242



signal black

Page 242

HYBAN 2.0 ACE



titan

Page 244



velvet black

Page 244



signal yellow

Page 244



polar white

Page 244

HYBAN 2.0



mellow mauve

Page 246



velvet black

Page 246



titan

Page 246



polar white

Page 246



monument grey

Page 246



living coral

Page 246



jade green

Page 246



glacier blue

Page 246



core green

Page 246



core blue

Page 246



cannoli cream

Page 246



chrome silver

Page 246



chrome rosé

Page 246



signal silver

Page 246



signal yellow

Page 246



signal orange

Page 246

HYBAN 2.0



Mips

velvet black

Page 246



Mips

titan

Page 246



Mips

signal yellow

Page 246

SKURB ACE



city vibes

Page 248



velvet black

Page 248



silver white

Page 248



jade green

Page 248



glacier blue

Page 248



Iriedaily plum

Page 248



Iriedaily black

Page 248

SKURB



midnight blue

Page 250



velvet black

Page 250



titan

Page 250



signal yellow

Page 250



signal orange

Page 250



pearl white

Page 250



Mips

velvet black

Page 250



Mips

polar white

Page 250



Mips

concrete grey

Page 250

SCRAPER 3.0 ACE



polar matt

Page 252



velvet black

Page 252



ultra blue

Page 252



signal orange

Page 252



ivy green

Page 252



concrete grey

Page 252



alaska grey

Page 252

SCRAPER 3.0



velvet black

Page 254



concrete grey

Page 254



ultra blue

Page 254



signal orange

Page 254



polar matt

Page 254

ADURO 2.0



midnight blue

Page 256



velvet black

Page 256



titan

Page 256



steel blue

Page 256



slate blue

Page 256



race white

Page 256



race grey

Page 256



race black

Page 256



neon yellow

Page 256



metallic copper

Page 256



maori
blackberry

Page 256



jade green

Page 256

ADURO 2.0



grit grey

Page 256



gold prism

Page 256



glare silver

Page 256



concrete grey

Page 256



blue art

Page 256



beige silhouette

Page 256



blue branches

Page 256



white triangle

Page 256



PEDELEC 2.0 ACE

NEW

VUES



champagne gold



champagne gold



CARACTÉRISTIQUES



Zoom Ace Urban



Fidlock



GlowStraps



Lumière USB



Capuche

ACCESSOIRES

- Housse ABUS
- Visière & kit hiver pour Pedelec 2.0

TECHNOLOGIE



VARIANTES



velvet black



signal yellow



pearl white



midnight blue



glacier blue



race grey



titan



blaze red



Article	EAN 4003318	couleur	Finition	Poids g	Taille	Tour de tête cm	Unité emb.
Pedelec 2.0 ACE	66732 9	velvet black	matt	390	S	51 - 55	1
Pedelec 2.0 ACE	81925 4	velvet black	matt	410	M	52 - 57	1
Pedelec 2.0 ACE	81929 2	velvet black	matt	430	L	56 - 62	1
Pedelec 2.0 ACE	66735 0	signal yellow	shiny	390	S	51 - 55	1
Pedelec 2.0 ACE	81928 5	signal yellow	shiny	410	M	52 - 57	1
Pedelec 2.0 ACE	81932 2	signal yellow	shiny	430	L	56 - 62	1
Pedelec 2.0 ACE	67337 5	pearl white	shiny	390	S	51 - 55	1
Pedelec 2.0 ACE	67338 2	pearl white	shiny	410	M	52 - 57	1
Pedelec 2.0 ACE	67339 9	pearl white	shiny	430	L	56 - 62	1
Pedelec 2.0 ACE	66736 7	midnight blue	matt	390	S	51 - 55	1
Pedelec 2.0 ACE	81927 8	midnight blue	matt	410	M	52 - 57	1
Pedelec 2.0 ACE	81931 5	midnight blue	matt	430	L	56 - 62	1
Pedelec 2.0 ACE	67340 5	glacier blue	matt	390	S	51 - 55	1
Pedelec 2.0 ACE	67341 2	glacier blue	matt	410	M	52 - 57	1
Pedelec 2.0 ACE	67342 9	glacier blue	matt	430	L	56 - 62	1
Pedelec 2.0 ACE	91909 1	race grey	shiny	390	S	51 - 55	1
Pedelec 2.0 ACE	91910 7	race grey	shiny	410	M	52 - 57	1
Pedelec 2.0 ACE	91911 4	race grey	shiny	430	L	56 - 62	1
Pedelec 2.0 ACE	91906 0	titan	matt	390	S	51 - 55	1
Pedelec 2.0 ACE	91907 7	titan	matt	410	M	52 - 57	1
Pedelec 2.0 ACE	91908 4	titan	matt	430	L	56 - 62	1
Pedelec 2.0 ACE	91912 1	champagne gold	shiny	390	S	51 - 55	1
Pedelec 2.0 ACE	91913 8	champagne gold	shiny	410	M	52 - 57	1
Pedelec 2.0 ACE	91914 5	champagne gold	shiny	430	L	56 - 62	1
Pedelec 2.0 ACE	91917 6	blaze red	shiny	390	S	51 - 55	1
Pedelec 2.0 ACE	91918 3	blaze red	shiny	410	M	52 - 57	1
Pedelec 2.0 ACE	91919 0	blaze red	shiny	430	L	56 - 62	1
Visière Pedelec 2.0 & Hyban 2.0	82888 1	gris			universelle		1
Visière Pedelec 2.0 & Hyban 2.0	82889 8	clear			universelle		1

Urban



PEDELEC 2.0

NEW

VUES



race grey



race grey



CARACTÉRISTIQUES



Zoom Ace Urban



Fidlock



GlowStraps



Lumière USB



Capuche

ACCESSOIRES

- Housse ABUS
- Visière & kit hiver pour Pedelec 2.0

TECHNOLOGIE



VARIANTES



velvet black

signal yellow

pearl white

midnight blue

glacier blue

titan

champagne gold



blaze red

velvet black

signal yellow

silver edition

Article	EAN 4003318	couleur	Finition	Poids g	Taille	Tour de tête cm	Unité emb.
Pedelec 2.0	40597 6	velvet black	matt	330	S	51 - 55	1
Pedelec 2.0	81919 3	velvet black	matt	350	M	52 - 57	1
Pedelec 2.0	81913 1	velvet black	matt	370	L	56 - 62	1
Pedelec 2.0	40595 2	signal yellow	shiny	330	S	51 - 55	1
Pedelec 2.0	81922 3	signal yellow	shiny	350	M	52 - 57	1
Pedelec 2.0	81916 2	signal yellow	shiny	370	L	56 - 62	1
Pedelec 2.0	40593 8	pearl white	shiny	330	S	51 - 55	1
Pedelec 2.0	40188 6	pearl white	shiny	350	M	52 - 57	1
Pedelec 2.0	40189 3	pearl white	shiny	370	L	56 - 62	1
Pedelec 2.0	40297 5	midnight blue	matt	330	S	51 - 55	1
Pedelec 2.0	81921 6	midnight blue	matt	350	M	52 - 57	1
Pedelec 2.0	81915 5	midnight blue	matt	370	L	56 - 62	1
Pedelec 2.0	40592 1	glacier blue	matt	330	S	51 - 55	1
Pedelec 2.0	40186 2	glacier blue	matt	350	M	52 - 57	1
Pedelec 2.0	40187 9	glacier blue	matt	370	L	56 - 62	1
Pedelec 2.0	91894 0	titan	matt	330	S	51 - 55	1
Pedelec 2.0	91895 7	titan	matt	350	M	52 - 57	1
Pedelec 2.0	91896 4	titan	matt	370	L	56 - 62	1
Pedelec 2.0	91900 8	champagne gold	shiny	330	S	51 - 55	1
Pedelec 2.0	91901 5	champagne gold	shiny	350	M	52 - 57	1
Pedelec 2.0	91902 2	champagne gold	shiny	370	L	56 - 62	1
Pedelec 2.0	91897 1	race grey	shiny	330	S	51 - 55	1
Pedelec 2.0	91898 8	race grey	shiny	350	M	52 - 57	1
Pedelec 2.0	91899 5	race grey	shiny	370	L	56 - 62	1
Pedelec 2.0	91903 9	blaze red	shiny	330	S	51 - 55	1
Pedelec 2.0	91904 6	blaze red	shiny	350	M	52 - 57	1
Pedelec 2.0	91905 3	blaze red	shiny	370	L	56 - 62	1
Pedelec 2.0 MIPS	89193 9	velvet black	matt	390	L	56 - 62	1
Pedelec 2.0 MIPS	89194 6	velvet black	matt	370	M	52 - 57	1
Pedelec 2.0 MIPS	89197 7	signal yellow	shiny	390	L	56 - 62	1
Pedelec 2.0 MIPS	89198 4	signal yellow	shiny	370	M	52 - 57	1
Pedelec 2.0 MIPS	89195 3	silver edition	matt	390	L	56 - 62	1
Pedelec 2.0 MIPS	89196 0	silver edition	matt	370	M	52 - 57	1

Urban



PEDELEC 1.1

VUES



steel blue



steel blue



CARACTÉRISTIQUES



Zoom Evo Adult



Fidlock



LED top



Capuche

ACCESSOIRES

- Housse ABUS

TECHNOLOGIE



VARIANTES



titan



pearl white



black edition

Article	EAN 4003318	couleur	Finition	Poids g	Taille	Tour de tête cm	Unité emb.
Pedelec 1.1	81907 0	titan	matt	350	M	52 - 57	1
Pedelec 1.1	81908 7	titan	matt	370	L	56 - 62	1
Pedelec 1.1	81909 4	steel blue	shiny	350	M	52 - 57	1
Pedelec 1.1	81910 0	steel blue	shiny	370	L	56 - 62	1
Pedelec 1.1	81911 7	pearl white	shiny	350	M	52 - 57	1
Pedelec 1.1	81912 4	pearl white	shiny	370	L	56 - 62	1
Pedelec 1.1	81905 6	black edition	matt	350	M	52 - 57	1
Pedelec 1.1	81906 3	black edition	matt	370	L	56 - 62	1



HUD-Y ACE

VUES



velvet black



velvet black



CARACTÉRISTIQUES



Zoom Ace Urban



Fidlock



TriVider



Feu arrière USB magnétique

ACCESSOIRES

- Housse ABUS
- Lumière USB
- Visière

TECHNOLOGIE



VARIANTES



shiny white



goldfish orange

Article	EAN 4003318	couleur	Finition	Poids g	Taille	Tour de tête cm	Unité emb.
HUD-Y ACE	91995 4	shiny white	shiny	400	S	51 - 55	1
HUD-Y ACE	91996 1	shiny white	shiny	430	M	54 - 58	1
HUD-Y ACE	91997 8	shiny white	shiny	460	L	57 - 61	1
HUD-Y ACE	91998 5	goldfish orange	shiny	400	S	51 - 55	1
HUD-Y ACE	91999 2	goldfish orange	shiny	430	M	54 - 58	1
HUD-Y ACE	04486 1	goldfish orange	shiny	460	L	57 - 61	1
HUD-Y ACE	91992 3	velvet black	matt	400	S	51 - 55	1
HUD-Y ACE	91993 0	velvet black	matt	430	M	54 - 58	1
HUD-Y ACE	91994 7	velvet black	matt	460	L	57 - 61	1
HUD-Y ACE Visières	82888 1	gris			universelle		1
HUD-Y ACE Visières	82889 8	clear			universelle		1
HUD-Y ACE Visières	82890 4				universelle		1



HUD-Y

VUES



goldfish orange



goldfish orange



CARACTÉRISTIQUES



Zoom Ace Urban



Fidlock



TriVider



Feu arrière USB magnétique



Visières flip flop

ACCESSOIRES

- Housse ABUS
- Lumière USB

TECHNOLOGIE



VARIANTES



velvet black



titan



signal yellow



race grey



midnight blue



flower white



champagne gold



shiny white

Article	EAN 4003318	couleur	Finition	Poids g	Taille	Tour de tête cm	Unité emb.
HUD-Y	91979 4	velvet black	matt	280	S	51 - 55	1
HUD-Y	66843 2	velvet black	matt	300	M	54 - 58	1
HUD-Y	66844 9	velvet black	matt	330	L	57 - 61	1
HUD-Y	91980 0	titan	matt	280	S	51 - 55	1
HUD-Y	66947 7	titan	matt	300	M	54 - 58	1
HUD-Y	67038 1	titan	matt	330	L	57 - 61	1
HUD-Y	91983 1	signal yellow	shiny	280	S	51 - 55	1
HUD-Y	67043 5	signal yellow	shiny	300	M	54 - 58	1
HUD-Y	67044 2	signal yellow	shiny	330	L	57 - 61	1
HUD-Y	91985 5	race grey	shiny	280	S	51 - 55	1
HUD-Y	67934 6	race grey	shiny	300	M	54 - 58	1
HUD-Y	67935 3	race grey	shiny	330	L	57 - 61	1
HUD-Y	91982 4	midnight blue	matt	280	S	51 - 55	1
HUD-Y	67041 1	midnight blue	matt	300	M	54 - 58	1
HUD-Y	67042 8	midnight blue	matt	330	L	57 - 61	1
HUD-Y	91981 7	flower white	shiny	280	S	51 - 55	1
HUD-Y	66944 6	flower white	shiny	300	M	54 - 58	1
HUD-Y	66945 3	flower white	shiny	330	L	57 - 61	1
HUD-Y	91984 8	champagne gold	matt	280	S	51 - 55	1
HUD-Y	67039 8	champagne gold	matt	300	M	54 - 58	1
HUD-Y	67040 4	champagne gold	matt	330	L	57 - 61	1
HUD-Y	91986 2	shiny white	shiny	280	S	51 - 55	1
HUD-Y	91987 9	shiny white	shiny	300	M	54 - 58	1
HUD-Y	91988 6	shiny white	shiny	330	L	57 - 61	1
HUD-Y	91989 3	goldfish orange	shiny	280	S	51 - 55	1
HUD-Y	91990 9	goldfish orange	shiny	300	M	54 - 58	1
HUD-Y	91991 6	goldfish orange	shiny	330	L	57 - 61	1

Urban



URBAN-I 3.0 ACE

VUES



metallic copper



metallic copper



CARACTÉRISTIQUES



Zoom Ace Urban



Fidlock



LED top



TriVider

ACCESSOIRES

- Housse ABUS
- Lumière USB

TECHNOLOGIE



VARIANTES



velvet black



goldfish orange



polar white

Article	EAN 4003318	couleur	Finition	Poids g	Taille	Tour de tête cm	Unité emb.
Urban-I 3.0 ACE	02940 0	velvet black	matt	250	S	51 - 55	1
Urban-I 3.0 ACE	02999 8	velvet black	matt	280	M	52 - 58	1
Urban-I 3.0 ACE	03244 8	velvet black	matt	300	L	56 - 61	1
Urban-I 3.0 ACE	03413 8	goldfish orange	shiny	250	S	51 - 55	1
Urban-I 3.0 ACE	03414 5	goldfish orange	shiny	280	M	52 - 58	1
Urban-I 3.0 ACE	03415 2	goldfish orange	shiny	300	L	56 - 61	1
Urban-I 3.0 ACE	03410 7	polar white	matt	250	S	51 - 55	1
Urban-I 3.0 ACE	03411 4	polar white	matt	280	M	52 - 58	1
Urban-I 3.0 ACE	03412 1	polar white	matt	300	L	56 - 61	1
Urban-I 3.0 ACE	03416 9	metallic copper	matt	250	S	51 - 55	1
Urban-I 3.0 ACE	03417 6	metallic copper	matt	280	M	52 - 58	1
Urban-I 3.0 ACE	03418 3	metallic copper	matt	300	L	56 - 61	1



URBAN-I 3.0

VUES



monument grey



monument grey



CARACTÉRISTIQUES



Zoom Ace Urban



Fidlock



LED top

ACCESSOIRES

- Housse ABUS
- Lumière USB

TECHNOLOGIE



VARIANTES



velvet black



titan



street art



polar white



mellow mauve



living coral



jade green



glacier blue



flower art



core green



core blue



cannoli cream



signal yellow



signal silver



signal orange



velvet black



titan



signal yellow

Article	EAN 4003318	couleur	Finition	Poids g	Taille	Tour de tête cm	Unité emb.
Urban-I 3.0	86857 3	velvet black	matt	250	S	51 - 55	1
Urban-I 3.0	86851 1	velvet black	matt	280	M	52 - 58	1
Urban-I 3.0	86852 8	velvet black	matt	300	L	56 - 61	1
Urban-I 3.0	86853 5	velvet black	matt	325	XL	61 - 65	1
Urban-I 3.0	86862 7	titan	matt	250	S	51 - 55	1
Urban-I 3.0	86863 4	titan	matt	280	M	52 - 58	1
Urban-I 3.0	86864 1	titan	matt	300	L	56 - 61	1
Urban-I 3.0	86865 8	titan	matt	325	XL	61 - 65	1
Urban-I 3.0	40192 3	street art	matt+shiny	250	S	51 - 55	1
Urban-I 3.0	40193 0	street art	matt+shiny	280	M	52 - 58	1
Urban-I 3.0	40194 7	street art	matt+shiny	300	L	56 - 61	1
Urban-I 3.0	40195 4	street art	matt+shiny	325	XL	61 - 65	1
Urban-I 3.0	86858 0	polar white	matt	250	S	51 - 55	1
Urban-I 3.0	86859 7	polar white	matt	280	M	52 - 58	1
Urban-I 3.0	86860 3	polar white	matt	300	L	56 - 61	1
Urban-I 3.0	86861 0	polar white	matt	325	XL	61 - 65	1
Urban-I 3.0	66720 6	monument grey	shiny	250	S	51 - 55	1
Urban-I 3.0	66721 3	monument grey	shiny	280	M	52 - 58	1
Urban-I 3.0	66722 0	monument grey	shiny	300	L	56 - 61	1
Urban-I 3.0	66723 7	monument grey	shiny	325	XL	61 - 65	1
Urban-I 3.0	66714 5	mellow mauve	shiny	250	S	51 - 55	1
Urban-I 3.0	66715 2	mellow mauve	shiny	280	M	52 - 58	1
Urban-I 3.0	66716 9	mellow mauve	shiny	300	L	56 - 61	1
Urban-I 3.0	86897 9	living coral	matt	250	S	51 - 55	1
Urban-I 3.0	86898 6	living coral	matt	280	M	52 - 58	1
Urban-I 3.0	88639 3	living coral	matt	300	L	56 - 61	1
Urban-I 3.0	86891 7	jade green	matt	250	S	51 - 55	1
Urban-I 3.0	86892 4	jade green	matt	280	M	52 - 58	1
Urban-I 3.0	86893 1	jade green	matt	300	L	56 - 61	1
Urban-I 3.0	86894 8	glacier blue	matt	250	S	51 - 55	1
Urban-I 3.0	86895 5	glacier blue	matt	280	M	52 - 58	1
Urban-I 3.0	86896 2	glacier blue	matt	300	L	56 - 61	1
Urban-I 3.0	40190 9	flower art	matt+shiny	250	S	51 - 55	1
Urban-I 3.0	40191 6	flower art	matt+shiny	280	M	52 - 58	1
Urban-I 3.0	64214 2	flower art	matt+shiny	300	L	56 - 61	1
Urban-I 3.0	86882 5	core green	matt	250	S	51 - 55	1
Urban-I 3.0	86883 2	core green	matt	280	M	52 - 58	1
Urban-I 3.0	86884 9	core green	matt	300	L	56 - 61	1
Urban-I 3.0	86885 6	core green	matt	325	XL	61 - 65	1
Urban-I 3.0	86878 8	core blue	matt	250	S	51 - 55	1
Urban-I 3.0	86879 5	core blue	matt	280	M	52 - 58	1
Urban-I 3.0	86880 1	core blue	matt	300	L	56 - 61	1
Urban-I 3.0	86881 8	core blue	matt	325	XL	61 - 65	1
Urban-I 3.0	66717 6	cannoli cream	shiny	250	S	51 - 55	1
Urban-I 3.0	66718 3	cannoli cream	shiny	280	M	52 - 58	1
Urban-I 3.0	66719 0	cannoli cream	shiny	300	L	56 - 61	1
Urban-I 3.0	86866 5	signal yellow	shiny	250	S	51 - 55	1
Urban-I 3.0	86867 2	signal yellow	shiny	280	M	52 - 58	1
Urban-I 3.0	86868 9	signal yellow	shiny	300	L	56 - 61	1
Urban-I 3.0	86869 6	signal yellow	shiny	325	XL	61 - 65	1
Urban-I 3.0	86874 0	signal silver	shiny	250	S	51 - 55	1
Urban-I 3.0	86875 7	signal silver	shiny	280	M	52 - 58	1
Urban-I 3.0	86876 4	signal silver	shiny	300	L	56 - 61	1
Urban-I 3.0	86877 1	signal silver	shiny	325	XL	61 - 65	1
Urban-I 3.0	86870 2	signal orange	shiny	250	S	51 - 55	1
Urban-I 3.0	86871 9	signal orange	shiny	280	M	52 - 58	1
Urban-I 3.0	86872 6	signal orange	shiny	300	L	56 - 61	1
Urban-I 3.0	86873 3	signal orange	shiny	325	XL	61 - 65	1
Urban-I 3.0 MIPS	89184 7	velvet black	matt	270	S	51 - 55	1
Urban-I 3.0 MIPS	89183 0	velvet black	matt	300	M	52 - 58	1
Urban-I 3.0 MIPS	89182 3	velvet black	matt	320	L	56 - 61	1
Urban-I 3.0 MIPS	89181 6	velvet black	matt	345	XL	61 - 65	1
Urban-I 3.0 MIPS	89187 8	titan	matt	270	S	51 - 55	1
Urban-I 3.0 MIPS	89186 1	titan	matt	300	M	52 - 58	1
Urban-I 3.0 MIPS	89185 4	titan	matt	320	L	56 - 61	1
Urban-I 3.0 MIPS	89188 5	titan	matt	345	XL	61 - 65	1
Urban-I 3.0 MIPS	89191 5	signal yellow	shiny	270	S	51 - 55	1
Urban-I 3.0 MIPS	89190 8	signal yellow	shiny	300	M	52 - 58	1
Urban-I 3.0 MIPS	89189 2	signal yellow	shiny	320	L	56 - 61	1
Urban-I 3.0 MIPS	89192 2	signal yellow	shiny	345	XL	61 - 65	1

YOUN-I ACE

VUES



metallic blue



metallic blue



CARACTÉRISTIQUES



Zoom Evo Adult



Boucle



LED top

ACCESSOIRES

- Housse ABUS
- Capuche Toplight

TECHNOLOGIE



VARIANTES



velvet black



sparkling titan



signal yellow



rosé gold



pearl white



metallic silver



metallic green



glacier blue



cherry red

Article	EAN 4003318	couleur	Finition	Poids g	Taille	Tour de tête cm	Unité emb.
Youn-I ACE	85693 8	velvet black	matt	250	S	48 - 54	1
Youn-I ACE	72612 5	velvet black	matt	270	M	52 - 57	1
Youn-I ACE	72613 2	velvet black	matt	300	L	56 - 61	1
Youn-I ACE	66783 1	sparkling titan	shiny	250	S	48 - 54	1
Youn-I ACE	66784 8	sparkling titan	shiny	270	M	52 - 57	1
Youn-I ACE	66788 6	sparkling titan	shiny	300	L	56 - 61	1
Youn-I ACE	66799 2	signal yellow	shiny	250	S	48 - 54	1
Youn-I ACE	66812 8	signal yellow	shiny	270	M	52 - 57	1
Youn-I ACE	66814 2	signal yellow	shiny	300	L	56 - 61	1
Youn-I ACE	66745 9	rosé gold	matt	250	S	48 - 54	1
Youn-I ACE	86943 3	rosé gold	matt	270	M	52 - 57	1
Youn-I ACE	66791 6	pearl white	shiny	250	S	48 - 54	1
Youn-I ACE	66792 3	pearl white	shiny	270	M	52 - 57	1
Youn-I ACE	66793 0	pearl white	shiny	300	L	56 - 61	1
Youn-I ACE	66742 8	metallic silver	matt	250	S	48 - 54	1
Youn-I ACE	81822 6	metallic silver	matt	270	M	52 - 57	1
Youn-I ACE	81823 3	metallic silver	matt	300	L	56 - 61	1
Youn-I ACE	66743 5	metallic green	matt	250	S	48 - 54	1
Youn-I ACE	81824 0	metallic green	matt	270	M	52 - 57	1
Youn-I ACE	81825 7	metallic green	matt	300	L	56 - 61	1
Youn-I ACE	66741 1	metallic blue	matt	250	S	48 - 54	1
Youn-I ACE	81820 2	metallic blue	matt	270	M	52 - 57	1
Youn-I ACE	81821 9	metallic blue	matt	300	L	56 - 61	1
Youn-I ACE	66775 6	glacier blue	shiny	250	S	48 - 54	1
Youn-I ACE	66776 3	glacier blue	shiny	270	M	52 - 57	1
Youn-I ACE	66777 0	glacier blue	shiny	300	L	56 - 61	1
Youn-I ACE	66773 2	cherry red	matt	250	S	48 - 54	1
Youn-I ACE	72616 3	cherry red	matt	270	M	52 - 57	1
Youn-I ACE	72617 0	cherry red	matt	300	L	56 - 61	1



HYBAN 2.0 LED

VUES



signal glacier



signal glacier



CARACTÉRISTIQUES



Zoom Ace Urban



Boucle



USB LED 360

ACCESSOIRES

- Housse ABUS
- Capuche Toplight

TECHNOLOGIE



VARIANTES



signal yellow



signal silver



signal black

Article	EAN 4003318	couleur	Finition	Poids g	Taille	Tour de tête cm	Unité emb.
Hyban 2.0 LED	61461 3	signal yellow	shiny	400	M	52 - 58	1
Hyban 2.0 LED	61462 0	signal yellow	shiny	455	L	56 - 61	1
Hyban 2.0 LED	61463 7	signal yellow	shiny	500	XL	58 - 63	1
Hyban 2.0 LED	61464 4	signal silver	shiny	400	M	52 - 58	1
Hyban 2.0 LED	61465 1	signal silver	shiny	455	L	56 - 61	1
Hyban 2.0 LED	61466 8	signal silver	shiny	500	XL	58 - 63	1
Hyban 2.0 LED	66711 4	signal glacier	matt	400	M	52 - 58	1
Hyban 2.0 LED	66712 1	signal glacier	matt	455	L	56 - 61	1
Hyban 2.0 LED	66713 8	signal glacier	matt	500	XL	58 - 63	1
Hyban 2.0 LED	61458 3	signal black	matt	400	M	52 - 58	1
Hyban 2.0 LED	61459 0	signal black	matt	455	L	56 - 61	1
Hyban 2.0 LED	61460 6	signal black	matt	500	XL	58 - 63	1



HYBAN 2.0 ACE

VUES



titan



titan



CARACTÉRISTIQUES



Zoom Ace Urban



Fidlock



LED top

ACCESSOIRES

- Housse ABUS
- Lumière USB
- Visière

TECHNOLOGIE



VARIANTES



velvet black



signal yellow



polar white

Article	EAN 4003318	couleur	Finition	Poids g	Taille	Tour de tête cm	Unité emb.
Hyban 2.0 ACE	86934 1	velvet black	matt	470	M	52 - 58	1
Hyban 2.0 ACE	86935 8	velvet black	matt	510	L	56 - 61	1
Hyban 2.0 ACE	86936 5	velvet black	matt	560	XL	58 - 63	1
Hyban 2.0 ACE	86937 2	titan	matt	470	M	52 - 58	1
Hyban 2.0 ACE	86938 9	titan	matt	510	L	56 - 61	1
Hyban 2.0 ACE	86939 6	titan	matt	560	XL	58 - 63	1
Hyban 2.0 ACE	86940 2	signal yellow	shiny	470	M	52 - 58	1
Hyban 2.0 ACE	86941 9	signal yellow	shiny	510	L	56 - 61	1
Hyban 2.0 ACE	86997 6	polar white	shiny	470	M	52 - 58	1
Hyban 2.0 ACE	86998 3	polar white	shiny	510	L	56 - 61	1
Visière Pedelec 2.0 & Hyban 2.0	82888 1	gris			universelle		1
Visière Pedelec 2.0 & Hyban 2.0	82889 8	clear			universelle		1



HYBAN 2.0

VUES



mellow mauve



mellow mauve



CARACTÉRISTIQUES



Zoom Ace Urban



Boucle



LED top

ACCESSOIRES

- Housse ABUS
- Lumière USB

TECHNOLOGIE



VARIANTES



velvet black



titan



polar white



monument grey



living coral



jade green



glacier blue



core green



core blue



cannoli cream



chrome silver



chrome rosé



signal silver



signal yellow



signal orange



velvet black



titan



signal yellow

Article	EAN 4003318	couleur	Finition	Poids g	Taille	Tour de tête cm	Unité emb.
Hyban 2.0	86899 3	velvet black	matt	400	M	52 - 58	1
Hyban 2.0	86900 6	velvet black	matt	460	L	56 - 61	1
Hyban 2.0	86901 3	velvet black	matt	500	XL	58 - 63	1
Hyban 2.0	86905 1	titan	matt	400	M	52 - 58	1
Hyban 2.0	86906 8	titan	matt	460	L	56 - 61	1
Hyban 2.0	86907 5	titan	matt	500	XL	58 - 63	1
Hyban 2.0	86902 0	polar white	shiny	400	M	52 - 58	1
Hyban 2.0	86903 7	polar white	shiny	460	L	56 - 61	1
Hyban 2.0	86904 4	polar white	shiny	500	XL	58 - 63	1
Hyban 2.0	66708 4	monument grey	shiny	400	M	52 - 58	1
Hyban 2.0	66709 1	monument grey	shiny	460	L	56 - 61	1
Hyban 2.0	66710 7	monument grey	shiny	500	XL	58 - 63	1
Hyban 2.0	66704 6	mellow mauve	shiny	400	M	52 - 58	1
Hyban 2.0	66705 3	mellow mauve	shiny	460	L	56 - 61	1
Hyban 2.0	86932 7	living coral	shiny	400	M	52 - 58	1
Hyban 2.0	86926 6	jade green	shiny	400	M	52 - 58	1
Hyban 2.0	86927 3	jade green	shiny	460	L	56 - 61	1
Hyban 2.0	86929 7	glacier blue	shiny	400	M	52 - 58	1
Hyban 2.0	86930 3	glacier blue	shiny	460	L	56 - 61	1
Hyban 2.0	86920 4	core green	shiny	400	M	52 - 58	1
Hyban 2.0	86921 1	core green	shiny	460	L	56 - 61	1
Hyban 2.0	86917 4	core blue	shiny	400	M	52 - 58	1
Hyban 2.0	86918 1	core blue	shiny	460	L	56 - 61	1
Hyban 2.0	66706 0	cannoli cream	shiny	400	M	52 - 58	1
Hyban 2.0	66707 7	cannoli cream	shiny	460	L	56 - 61	1
Hyban 2.0	86911 2	signal orange	shiny	400	M	52 - 58	1
Hyban 2.0	86912 9	signal orange	shiny	460	L	56 - 61	1
Hyban 2.0	86913 6	signal orange	shiny	480	XL	58 - 63	1
Hyban 2.0	86914 3	signal silver	shiny	400	M	52 - 58	1
Hyban 2.0	86915 0	signal silver	shiny	460	L	56 - 61	1
Hyban 2.0	86916 7	signal silver	shiny	480	XL	58 - 63	1
Hyban 2.0	86908 2	signal yellow	shiny	400	M	52 - 58	1
Hyban 2.0	86909 9	signal yellow	shiny	460	L	56 - 61	1
Hyban 2.0	86910 5	signal yellow	shiny	480	XL	58 - 63	1
Hyban 2.0 MIPS	89199 1	velvet black	matt	480	L	56 - 61	1
Hyban 2.0	40184 8	chrome silver	shiny	400	M	52 - 58	1
Hyban 2.0	40197 8	chrome silver	shiny	460	L	56 - 61	1
Hyban 2.0	40185 5	chrome rosé	shiny	400	M	52 - 58	1
Hyban 2.0 MIPS	89200 4	velvet black	matt	420	M	52 - 58	1
Hyban 2.0 MIPS	89201 1	velvet black	matt	500	XL	58 - 63	1
Hyban 2.0 MIPS	89202 8	titan	matt	480	L	56 - 61	1
Hyban 2.0 MIPS	89203 5	titan	matt	420	M	52 - 58	1
Hyban 2.0 MIPS	89204 2	titan	matt	500	XL	58 - 63	1
Hyban 2.0 MIPS	89205 9	signal yellow	shiny	480	L	56 - 61	1
Hyban 2.0 MIPS	89206 6	signal yellow	shiny	420	M	52 - 58	1
Hyban 2.0 MIPS	89207 3	signal yellow	shiny	500	XL	58 - 63	1

Urbain



SKURB ACE

VUES



city vibes



city vibes



CARACTÉRISTIQUES



Zoom Ace MTB



Boucle



TECHNOLOGIE



VARIANTES



velvet black

silver white

jade green

glacier blue

Iriedaily plum

Iriedaily black

Article	EAN 4003318	couleur	Finition	Poids g	Taille	Tour de tête cm	Unité emb.
Skurb ACE	40385 9	velvet black	matt+shiny	310	S	52 - 56	1
Skurb ACE	40386 6	velvet black	matt+shiny	320	M	55 - 59	1
Skurb ACE	40387 3	velvet black	matt+shiny	340	L	58 - 61	1
Skurb ACE	40394 1	silver white	matt+shiny	310	S	52 - 56	1
Skurb ACE	40395 8	silver white	matt+shiny	320	M	55 - 59	1
Skurb ACE	40396 5	silver white	matt+shiny	340	L	58 - 61	1
Skurb ACE	40391 0	jade green	matt+shiny	310	S	52 - 56	1
Skurb ACE	40392 7	jade green	matt+shiny	320	M	55 - 59	1
Skurb ACE	40393 4	jade green	matt+shiny	340	L	58 - 61	1
Skurb ACE	40388 0	glacier blue	matt+shiny	310	S	52 - 56	1
Skurb ACE	40389 7	glacier blue	matt+shiny	320	M	55 - 59	1
Skurb ACE	40390 3	glacier blue	matt+shiny	340	L	58 - 61	1
Skurb ACE	40400 9	Iriedaily plum	matt+shiny	310	S	52 - 56	1
Skurb ACE	40401 6	Iriedaily plum	matt+shiny	320	M	55 - 59	1
Skurb ACE	40397 2	Iriedaily black	matt+shiny	310	S	52 - 56	1
Skurb ACE	40398 9	Iriedaily black	matt+shiny	320	M	55 - 59	1
Skurb ACE	40399 6	Iriedaily black	matt+shiny	340	L	58 - 61	1
Skurb ACE	96455 8	city vibes	shiny	300	S	52 - 56	1
Skurb ACE	96456 5	city vibes	shiny	310	M	55 - 59	1
Skurb ACE	96457 2	city vibes	shiny	340	L	58 - 61	1



SKURB

VUES



midnight blue



midnight blue



CARACTÉRISTIQUES



Zoom Ace MTB



Boucle

TECHNOLOGIE



VARIANTES



velvet black



titan



signal yellow



signal orange



pearl white



velvet black



polar white



concrete grey

Article	EAN 4003318	couleur	Finition	Poids g	Taille	Tour de tête cm	Unité emb.
Skurb	40367 5	velvet black	matt	300	S	52 - 56	1
Skurb	40368 2	velvet black	matt	310	M	55 - 59	1
Skurb	40369 9	velvet black	matt	340	L	58 - 61	1
Skurb	40370 5	titan	matt	300	S	52 - 56	1
Skurb	40371 2	titan	matt	310	M	55 - 59	1
Skurb	40372 9	titan	matt	340	L	58 - 61	1
Skurb	40382 8	signal yellow	shiny	300	S	52 - 56	1
Skurb	40383 5	signal yellow	shiny	310	M	55 - 59	1
Skurb	40384 2	signal yellow	shiny	340	L	58 - 61	1
Skurb	40379 8	signal orange	shiny	300	S	52 - 56	1
Skurb	40380 4	signal orange	shiny	310	M	55 - 59	1
Skurb	40381 1	signal orange	shiny	340	L	58 - 61	1
Skurb	40373 6	pearl white	shiny	300	S	52 - 56	1
Skurb	40374 3	pearl white	shiny	310	M	55 - 59	1
Skurb	40375 0	pearl white	shiny	340	L	58 - 61	1
Skurb	40376 7	midnight blue	shiny	300	S	52 - 56	1
Skurb	40377 4	midnight blue	shiny	310	M	55 - 59	1
Skurb	40378 1	midnight blue	shiny	340	L	58 - 61	1
Skurb MIPS	40627 0	velvet black	matt	360	S	52 - 56	1
Skurb MIPS	40628 7	velvet black	matt	380	M	55 - 59	1
Skurb MIPS	40629 4	velvet black	matt	410	L	58 - 61	1
Skurb MIPS	40624 9	polar white	matt	360	S	52 - 56	1
Skurb MIPS	40625 6	polar white	matt	380	M	55 - 59	1
Skurb MIPS	40626 3	polar white	matt	410	L	58 - 61	1
Skurb MIPS	40630 0	concrete grey	matt	360	S	52 - 56	1
Skurb MIPS	40631 7	concrete grey	matt	380	M	55 - 59	1
Skurb MIPS	40632 4	concrete grey	matt	410	L	58 - 61	1



SCRAPER 3.0 ACE

VUES



polar matt



polar matt



CARACTÉRISTIQUES



Zoom Ace Urban



Boucle

ACCESSOIRES

- Housse ABUS
- Scraper 3.0 kit hiver

TECHNOLOGIE



VARIANTES



velvet black



ultra blue



signal orange



ivy green



concrete grey



alaska grey

Article	EAN 4003318	couleur	Finition	Poids g	Taille	Tour de tête cm	Unité emb.
Scraper 3.0 ACE	81770 0	velvet black	matt	460	M	54 - 58	1
Scraper 3.0 ACE	81771 7	velvet black	matt	510	L	57 - 61	1
Scraper 3.0 ACE	81774 8	ultra blue	matt	460	M	54 - 58	1
Scraper 3.0 ACE	81775 5	ultra blue	matt	510	L	57 - 61	1
Scraper 3.0 ACE	81778 6	signal orange	matt	460	M	54 - 58	1
Scraper 3.0 ACE	81779 3	signal orange	matt	510	L	57 - 61	1
Scraper 3.0 ACE	81780 9	polar matt	matt	460	M	54 - 58	1
Scraper 3.0 ACE	81781 6	polar matt	matt	510	L	57 - 61	1
Scraper 3.0 ACE	86961 7	ivy green	shiny	460	M	54 - 58	1
Scraper 3.0 ACE	86962 4	ivy green	shiny	510	L	57 - 61	1
Scraper 3.0 ACE	81772 4	concrete grey	matt	460	M	54 - 58	1
Scraper 3.0 ACE	81773 1	concrete grey	matt	510	L	57 - 61	1
Scraper 3.0 ACE	86959 4	alaska grey	shiny	460	M	54 - 58	1
Scraper 3.0 ACE	86960 0	alaska grey	shiny	510	L	57 - 61	1



SCRAPER 3.0

VUES



velvet black



velvet black



CARACTÉRISTIQUES



Zoom Ace Urban



Boucle

ACCESSOIRES

- Housse ABUS
- Scrapper 3.0
kit hiver

TECHNOLOGIE



VARIANTES



concrete grey



ultra blue



signal orange



polar matt

Article	EAN 4003318	couleur	Finition	Poids g	Taille	Tour de tête cm	Unité emb.
Scraper 3.0	81758 8	velvet black	matt	450	M	54 - 58	1
Scraper 3.0	81759 5	velvet black	matt	490	L	57 - 62	1
Scraper 3.0	81760 1	concrete grey	matt	450	M	54 - 58	1
Scraper 3.0	81761 8	concrete grey	matt	490	L	57 - 62	1
Scraper 3.0	81762 5	ultra blue	matt	450	M	54 - 58	1
Scraper 3.0	81763 2	ultra blue	matt	490	L	57 - 62	1
Scraper 3.0	81766 3	signal orange	matt	450	M	54 - 58	1
Scraper 3.0	81767 0	signal orange	matt	490	L	57 - 62	1
Scraper 3.0	81768 7	polar matt	matt	450	M	54 - 58	1
Scraper 3.0	81769 4	polar matt	matt	490	L	57 - 62	1



ADURO 2.0

VUES



midnight blue



midnight blue



CARACTÉRISTIQUES



Zoom Evo Adult



Boucle



LED

ACCESSOIRES

- Capuche
- Housse ABUS

TECHNOLOGIE



VARIANTES



Article	EAN 4003318	couleur	Finition	Poids g	Taille	Tour de tête cm	Unité emb.
Aduro 2.0	82665 8	velvet black	matt	275	S	51 - 55	1
Aduro 2.0	72544 9	velvet black	matt	295	M	52 - 58	1
Aduro 2.0	72545 6	velvet black	matt	325	L	58 - 62	1
Aduro 2.0	86977 8	titan	matt	275	S	51 - 55	1
Aduro 2.0	86978 5	titan	matt	295	M	52 - 58	1
Aduro 2.0	86979 2	titan	matt	325	L	58 - 62	1
Aduro 2.0	82664 1	steel blue	matt	275	S	51 - 55	1
Aduro 2.0	81933 9	steel blue	matt	295	M	52 - 58	1
Aduro 2.0	81937 7	steel blue	matt	325	L	58 - 62	1
Aduro 2.0	63987 6	slate blue	matt	275	S	51 - 55	1
Aduro 2.0	63988 3	slate blue	matt	295	M	52 - 58	1
Aduro 2.0	63989 0	slate blue	matt	325	L	58 - 62	1
Aduro 2.0	72550 0	race white	matt	295	M	52 - 58	1
Aduro 2.0	72551 7	race white	matt	325	L	58 - 62	1
Aduro 2.0	82662 7	race grey	matt	275	S	51 - 55	1
Aduro 2.0	72548 7	race grey	matt	295	M	52 - 58	1
Aduro 2.0	72549 4	race grey	matt	325	L	58 - 62	1
Aduro 2.0	82661 0	race black	matt	275	S	51 - 55	1
Aduro 2.0	72546 3	race black	matt	295	M	52 - 58	1
Aduro 2.0	72547 0	race black	matt	325	L	58 - 62	1
Aduro 2.0	82659 7	neon yellow	shiny	275	S	51 - 55	1
Aduro 2.0	81934 6	neon yellow	shiny	295	M	52 - 58	1
Aduro 2.0	81938 4	neon yellow	shiny	325	L	58 - 62	1
Aduro 2.0	81935 3	metallic copper	matt	295	M	52 - 58	1
Aduro 2.0	81939 1	metallic copper	matt	325	L	58 - 62	1
Aduro 2.0	82658 0	maori blackberry	matt	275	S	51 - 55	1
Aduro 2.0	72558 6	maori blackberry	matt	295	M	52 - 58	1
Aduro 2.0	72559 3	maori blackberry	matt	325	L	58 - 62	1
Aduro 2.0	63985 2	jade green	matt	295	M	52 - 58	1
Aduro 2.0	63986 9	jade green	matt	325	L	58 - 62	1
Aduro 2.0	63981 4	grit grey	matt	275	S	51 - 55	1
Aduro 2.0	63982 1	grit grey	matt	295	M	52 - 58	1
Aduro 2.0	63983 8	grit grey	matt	325	L	58 - 62	1
Aduro 2.0	86983 9	gold prism	shiny	275	S	51 - 55	1
Aduro 2.0	86984 6	gold prism	shiny	295	M	52 - 58	1
Aduro 2.0	86980 8	glare silver	matt	275	S	51 - 55	1
Aduro 2.0	86981 5	glare silver	matt	295	M	52 - 58	1
Aduro 2.0	86982 2	glare silver	matt	325	L	58 - 62	1
Aduro 2.0	82657 3	concrete grey	matt	275	S	51 - 55	1
Aduro 2.0	81936 0	concrete grey	matt	295	M	52 - 58	1
Aduro 2.0	81940 7	concrete grey	matt	325	L	58 - 62	1
Aduro 2.0	82656 6	blue art	shiny	275	S	51 - 55	1
Aduro 2.0	72770 2	blue art	shiny	295	M	52 - 58	1
Aduro 2.0	72771 9	blue art	shiny	325	L	58 - 62	1
Aduro 2.0	95686 7	beige silhouette	shiny	275	S	51 - 55	1
Aduro 2.0	95687 4	beige silhouette	shiny	295	M	52 - 58	1
Aduro 2.0	95684 3	blue branches	shiny	275	S	51 - 55	1
Aduro 2.0	95685 0	blue branches	shiny	295	M	52 - 58	1
Aduro 2.0	95688 1	white triangle	shiny	275	S	51 - 55	1
Aduro 2.0	95689 8	white triangle	shiny	295	M	52 - 58	1
Aduro 2.0	95690 4	midnight blue	shiny	275	S	51 - 55	1
Aduro 2.0	95691 1	midnight blue	shiny	295	M	52 - 58	1
Aduro 2.0	95692 8	midnight blue	shiny	325	L	58 - 62	1

Urbain



ENFANTS



YOUDROP FF



sage green

Page 262



velvet black

Page 262



midnight blue

Page 262



chalk grey

Page 262

YOUDROP



sage green

Page 264



shiny black

Page 264



icon yellow

Page 264



wildberry red

Page 264

YOUN-I 2.0



cool grey

Page 266



velvet black

Page 266



street art

Page 266



sparkling titan

Page 266



sparkling pink

Page 266



sparkling green

Page 266



sparkling blue

Page 266



signal yellow

Page 266



polar white

Page 266



living coral

Page 266



grey star

Page 266



blue anchor

Page 266



grey flash

Page 266



glacier blue

Page 266



flower art

Page 266



cherry heart

Page 266



blaze red

Page 266



black violett

Page 266



rose gold

Page 266



midnight blue

Page 266



iced mint

Page 266

YOUN-I MIPS



Mips

velvet black

Page 268



Mips

sparkling green

Page 268



Mips

polar matt

Page 268

MOUNTZ



midnight blue

Page 270



velvet black

Page 270



polar white

Page 270



shrimp orange

Page 270



celeste green

Page 270



fuchsia pink

Page 270



glacier blue

Page 270



russet red

Page 270



jade green

Page 270

SKURB KID



green jungle

Page 272



shiny pink

Page 272



shiny green

Page 272



shiny red

Page 272



midnight blue

Page 272



goldfish orange

Page 272



shiny black

Page 272



cream summer

Page 272



white crowns

Page 272



grey stars

Page 272

SMILEY 3.0 ACE LED



velvet black

Page 274



shiny white

Page 274



shiny grey

Page 274



royal purple

Page 274



royal green

Page 274



royal blue

Page 274

SMILEY 3.0 LED



blue car

Page 276



rose strawberry

Page 276



grey space

Page 276



blue rainbow

Page 276

SMILEY 3.0



pink butterfly

Page 278



shiny yellow

Page 278



shiny red

Page 278



shiny pink

Page 278



shiny orange

Page 278



shiny green

Page 278



shiny blue

Page 278



rose princess

Page 278



purple star

Page 278



orange monster

Page 278



grey police

Page 278



grey horse

Page 278



green robo

Page 278



green nordic

Page 278



blue whale

Page 278



blue croco

Page 278

YOUDROP FF

VUES



sage green



sage green



CARACTÉRISTIQUES



Zoom Ace Youdrop



Visière velcro



Mentonnière amovible



Réfecteur

TECHNOLOGIE



VARIANTES



velvet black



midnight blue



chalk grey

Article	EAN 4003318	couleur	Finition	Poids g	Taille	Tour de tête cm	Unité emb.
YouDrop FF	03421 3	sage green	matt	440	S	48 - 55	1
YouDrop FF	03419 0	velvet black	matt	440	S	48 - 55	1
YouDrop FF	03420 6	midnight blue	matt	440	S	48 - 55	1
YouDrop FF	03422 0	chalk grey	matt	440	S	48 - 55	1



YOUDROP

VUES



sage green



sage green



CARACTÉRISTIQUES



Zoom Ace Youdrop



Réflecteur



Visière velcro

ACCESSOIRES

- Housse ABUS

TECHNOLOGIE



VARIANTES



shiny black



icon yellow



wildberry red

Article	EAN 4003318	couleur	Finition	Poids g	Taille	Tour de tête cm	Unité emb.
YouDrop	03423 7	shiny black	shiny	310	S	48 - 55	1
YouDrop	03426 8	icon yellow	shiny	310	S	48 - 55	1
YouDrop	03431 2	sage green	shiny	310	S	48 - 55	1
YouDrop	03425 1	wildberry red	shiny	310	S	48 - 55	1



YOUN-I 2.0

VUES



cool grey



cool grey



CARACTÉRISTIQUES



Zoom Ace Urban



Boucle



LED top

ACCESSOIRES

- Housse ABUS
- Lumière USB



Vainqueur du test de Stiftung Warentest

TECHNOLOGIE



VARIANTES



Article	EAN 4003318	couleur	Finition	Poids g	Taille	Tour de tête cm	Unité emb.
Youn-l 2.0	40150 3	velvet black	matt	240	S	48 - 54	1
Youn-l 2.0	40151 0	velvet black	matt	260	M	52 - 57	1
Youn-l 2.0	67047 3	street art	matt+shiny	240	S	48 - 54	1
Youn-l 2.0	67048 0	street art	matt+shiny	260	M	52 - 57	1
Youn-l 2.0	40170 1	sparkling titan	shiny	240	S	48 - 54	1
Youn-l 2.0	40171 8	sparkling titan	shiny	260	M	52 - 57	1
Youn-l 2.0	40164 0	sparkling pink	shiny	240	S	48 - 54	1
Youn-l 2.0	40165 7	sparkling pink	shiny	260	M	52 - 57	1
Youn-l 2.0	40160 2	sparkling green	shiny	240	S	48 - 54	1
Youn-l 2.0	40161 9	sparkling green	shiny	260	M	52 - 57	1
Youn-l 2.0	40158 9	sparkling blue	shiny	240	S	48 - 54	1
Youn-l 2.0	40159 6	sparkling blue	shiny	260	M	52 - 57	1
Youn-l 2.0	40162 6	signal yellow	shiny	240	S	48 - 54	1
Youn-l 2.0	40163 3	signal yellow	shiny	260	M	52 - 57	1
Youn-l 2.0	40152 7	polar white	shiny	240	S	48 - 54	1
Youn-l 2.0	40153 4	polar white	shiny	260	M	52 - 57	1
Youn-l 2.0	40156 5	living coral	shiny	240	S	48 - 54	1
Youn-l 2.0	40157 2	living coral	shiny	260	M	52 - 57	1
Youn-l 2.0	63810 7	grey star	matt+shiny	240	S	48 - 54	1
Youn-l 2.0	63811 4	grey star	matt+shiny	260	M	52 - 57	1
Youn-l 2.0	91890 2	cool grey	matt	240	S	48 - 54	1
Youn-l 2.0	91891 9	cool grey	matt	260	M	52 - 57	1
Youn-l 2.0	63812 1	grey flash	matt+shiny	240	S	48 - 54	1
Youn-l 2.0	63813 8	grey flash	matt+shiny	260	M	52 - 57	1
Youn-l 2.0	40154 1	glacier blue	shiny	240	S	48 - 54	1
Youn-l 2.0	40155 8	glacier blue	shiny	260	M	52 - 57	1
Youn-l 2.0	67045 9	flower art	matt+shiny	240	S	48 - 54	1
Youn-l 2.0	67046 6	flower art	matt+shiny	260	M	52 - 57	1
Youn-l 2.0	63808 4	cherry heart	matt+shiny	240	S	48 - 54	1
Youn-l 2.0	63809 1	cherry heart	matt+shiny	260	M	52 - 57	1
Youn-l 2.0	63814 5	blue anchor	matt+shiny	240	S	48 - 54	1
Youn-l 2.0	63815 2	blue anchor	matt+shiny	260	M	52 - 57	1
Youn-l 2.0	40168 8	blaze red	shiny	240	S	48 - 54	1
Youn-l 2.0	40169 5	blaze red	shiny	260	M	52 - 57	1
Youn-l 2.0	40166 4	black violet	shiny	240	S	48 - 54	1
Youn-l 2.0	40167 1	black violet	shiny	260	M	52 - 57	1
Youn-l 2.0	91888 9	rose gold	matt	240	S	48 - 54	1
Youn-l 2.0	91889 6	rose gold	matt	260	M	52 - 57	1
Youn-l 2.0	91885 8	midnight blue	matt	240	S	48 - 54	1
Youn-l 2.0	91887 2	midnight blue	matt	260	M	52 - 57	1
Youn-l 2.0	91892 6	iced mint	matt	240	S	48 - 54	1
Youn-l 2.0	91893 3	iced mint	matt	260	M	52 - 57	1



YOUN-I MIPS

VUES



velvet black



velvet black



CARACTÉRISTIQUES



Zoom Evo Kids



Boucle



LED top

ACCESSOIRES

- Housse ABUS
- Lumière USB
- Capuche de pluie Toplight

TECHNOLOGIE



VARIANTES



sparkling green



polar matt

Article	EAN 4003318	couleur	Finition	Poids g	Taille	Tour de tête cm	Unité emb.
Youn-I MIPS	38811 8	velvet black	matt	260	S	48 - 54	1
Youn-I MIPS	38812 5	velvet black	matt	280	M	52 - 57	1
Youn-I MIPS	38813 2	sparkling green	shiny	260	S	48 - 54	1
Youn-I MIPS	38814 9	sparkling green	shiny	280	M	52 - 57	1
Youn-I MIPS	38809 5	polar matt	matt	260	S	48 - 54	1
Youn-I MIPS	38810 1	polar matt	matt	280	M	52 - 57	1



MOUNTZ

VUES



midnight blue



midnight blue



CARACTÉRISTIQUES



Zoom Ace Urban



Boucle

ACCESSOIRES

- Housse ABUS

TECHNOLOGIE



VARIANTES



velvet black



polar white



shrimp orange



celeste green



fuchsia pink



glacier blue



russet red



jade green

Article	EAN 4003318	couleur	Finition	Poids g	Taille	Tour de tête cm	Unité emb.
MountZ	86965 5	velvet black	matt	245	S	48 - 54	1
MountZ	86966 2	velvet black	matt	280	M	52 - 57	1
MountZ	86967 9	polar white	matt	245	S	48 - 54	1
MountZ	86968 6	polar white	matt	280	M	52 - 57	1
MountZ	86969 3	midnight blue	shiny	245	S	48 - 54	1
MountZ	86970 9	midnight blue	shiny	280	M	52 - 57	1
MountZ	86971 6	shrimp orange	shiny	245	S	48 - 54	1
MountZ	86972 3	shrimp orange	shiny	280	M	52 - 57	1
MountZ	86975 4	celeste green	shiny	245	S	48 - 54	1
MountZ	86976 1	celeste green	shiny	280	M	52 - 57	1
MountZ	86973 0	fuchsia pink	shiny	245	S	48 - 54	1
MountZ	86974 7	fuchsia pink	shiny	280	M	52 - 57	1
MountZ	40174 9	glacier blue	matt	245	S	48 - 54	1
MountZ	40175 6	glacier blue	matt	280	M	52 - 57	1
MountZ	40178 7	russet red	matt	245	S	48 - 54	1
MountZ	40179 4	russet red	matt	280	M	52 - 57	1
MountZ	40180 0	jade green	matt	245	S	48 - 54	1
MountZ	40181 7	jade green	matt	280	M	52 - 57	1



SKURB KID

VUES



green jungle



green jungle



CARACTÉRISTIQUES



Zoom Evo Kids



Boucle



USB LED top

ACCESSOIRES

- Housse ABUS
- Lumière USB

TECHNOLOGIE



VARIANTES



shiny pink

shiny green

shiny red

midnight blue

goldfish orange

shiny black

cream summer

white crowns

grey stars

Article	EAN 4003318	couleur	Finition	Poids g	Taille	Tour de tête cm	Unité emb.
Skurb Kid	04452 6	shiny pink	shiny	240	S	45 - 50	1
Skurb Kid	04650 6	shiny pink	shiny	250	M	50 - 55	1
Skurb Kid	04428 1	shiny green	shiny	240	S	45 - 50	1
Skurb Kid	04440 3	shiny green	shiny	250	M	50 - 55	1
Skurb Kid	04300 0	shiny red	shiny	240	S	45 - 50	1
Skurb Kid	04426 7	shiny red	shiny	250	M	50 - 55	1
Skurb Kid	04283 6	midnight blue	shiny	240	S	45 - 50	1
Skurb Kid	04289 8	midnight blue	shiny	250	M	50 - 55	1
Skurb Kid	04677 3	goldfish orange	shiny	240	S	45 - 50	1
Skurb Kid	04678 0	goldfish orange	shiny	250	M	50 - 55	1
Skurb Kid	04296 6	shiny black	shiny	240	S	45 - 50	1
Skurb Kid	04298 0	shiny black	shiny	250	M	50 - 55	1
Skurb Kid	04679 7	cream summer	shiny	240	S	45 - 50	1
Skurb Kid	04680 3	cream summer	shiny	250	M	50 - 55	1
Skurb Kid	04681 0	white crowns	shiny	240	S	45 - 50	1
Skurb Kid	04718 3	white crowns	shiny	250	M	50 - 55	1
Skurb Kid	04744 2	grey stars	shiny	240	S	45 - 50	1
Skurb Kid	04746 6	grey stars	shiny	250	M	50 - 55	1
Skurb Kid	04772 5	green jungle	shiny	240	S	45 - 50	1
Skurb Kid	04774 9	green jungle	shiny	250	M	50 - 55	1



SMILEY 3.0 ACE LED

VUES



velvet black



velvet black



CARACTÉRISTIQUES



Zoom Ace Kids



Boucle



USB LED top

ACCESSOIRES

- Housse ABUS
- Lumière USB

TECHNOLOGIE



VARIANTES



shiny white

shiny grey

royal purple

royal green

royal blue

Article	EAN 4003318	couleur	Finition	Poids g	Taille	Tour de tête cm	Unité emb.
Smiley 3.0 ACE LED	67714 4	shiny white	shiny	230	S	45 - 50	1
Smiley 3.0 ACE LED	67715 1	shiny white	shiny	250	M	50 - 55	1
Smiley 3.0 ACE LED	67716 8	shiny grey	shiny	230	S	45 - 50	1
Smiley 3.0 ACE LED	67717 5	shiny grey	shiny	250	M	50 - 55	1
Smiley 3.0 ACE LED	67712 0	royal purple	shiny	230	S	45 - 50	1
Smiley 3.0 ACE LED	67713 7	royal purple	shiny	250	M	50 - 55	1
Smiley 3.0 ACE LED	67710 6	royal green	shiny	230	S	45 - 50	1
Smiley 3.0 ACE LED	67711 3	royal green	shiny	250	M	50 - 55	1
Smiley 3.0 ACE LED	67708 3	royal blue	shiny	230	S	45 - 50	1
Smiley 3.0 ACE LED	67709 0	royal blue	shiny	250	M	50 - 55	1
Smiley 3.0 ACE LED	66228 7	velvet black	matt	230	S	45 - 50	1
Smiley 3.0 ACE LED	66239 3	velvet black	matt	250	M	50 - 55	1



SMILEY 3.0 LED

VUES



blue car



blue car



CARACTÉRISTIQUES



Zoom Ace Kids



Boucle



USB LED top

ACCESSOIRES

- Housse ABUS
- Lumière USB

TECHNOLOGIE



VARIANTES



rose strawberry



grey space



blue rainbow

Article	EAN 4003318	couleur	Finition	Poids g	Taille	Tour de tête cm	Unité emb.
Smiley 3.0 LED	67706 9	rose strawberry	shiny	230	S	45 - 50	1
Smiley 3.0 LED	67707 6	rose strawberry	shiny	250	M	50 - 55	1
Smiley 3.0 LED	67298 9	grey space	shiny	230	S	45 - 50	1
Smiley 3.0 LED	67299 6	grey space	shiny	250	M	50 - 55	1
Smiley 3.0 LED	67300 9	blue rainbow	shiny	230	S	45 - 50	1
Smiley 3.0 LED	67301 6	blue rainbow	shiny	250	M	50 - 55	1
Smiley 3.0 LED	67296 5	blue car	shiny	230	S	45 - 50	1
Smiley 3.0 LED	67297 2	blue car	shiny	250	M	50 - 55	1



SMILEY 3.0

VUES



pink butterfly



pink butterfly



CARACTÉRISTIQUES



Zoom Ace Kids



Boucle

ACCESSOIRES

- Housse ABUS
- Lumière USB

TECHNOLOGIE



VARIANTES



shiny yellow



shiny red



shiny pink



shiny orange



shiny green



shiny blue



rose princess



purple star



orange monster



grey police



grey horse



green robo



green nordic



blue whale



blue croco

Article	EAN 4003318	couleur	Finition	Poids g	Taille	Tour de tête cm	Unité emb.
Smiley 3.0	67277 4	shiny yellow	shiny	220	S	45 - 50	1
Smiley 3.0	67278 1	shiny yellow	shiny	240	M	50 - 55	1
Smiley 3.0	67273 6	shiny red	shiny	220	S	45 - 50	1
Smiley 3.0	67274 3	shiny red	shiny	240	M	50 - 55	1
Smiley 3.0	67271 2	shiny pink	shiny	220	S	45 - 50	1
Smiley 3.0	67272 9	shiny pink	shiny	240	M	50 - 55	1
Smiley 3.0	67275 0	shiny orange	shiny	220	S	45 - 50	1
Smiley 3.0	67276 7	shiny orange	shiny	240	M	50 - 55	1
Smiley 3.0	67279 8	shiny green	shiny	220	S	45 - 50	1
Smiley 3.0	67280 4	shiny green	shiny	240	M	50 - 55	1
Smiley 3.0	67294 1	shiny blue	shiny	220	S	45 - 50	1
Smiley 3.0	67295 8	shiny blue	shiny	240	M	50 - 55	1
Smiley 3.0	67250 7	rose princess	shiny	220	S	45 - 50	1
Smiley 3.0	67251 4	rose princess	shiny	240	M	50 - 55	1
Smiley 3.0	67259 0	purple star	shiny	220	S	45 - 50	1
Smiley 3.0	67260 6	purple star	shiny	240	M	50 - 55	1
Smiley 3.0	67257 6	pink butterfly	shiny	220	S	45 - 50	1
Smiley 3.0	67258 3	pink butterfly	shiny	240	M	50 - 55	1
Smiley 3.0	67265 1	orange monster	shiny	220	S	45 - 50	1
Smiley 3.0	67266 8	orange monster	shiny	240	M	50 - 55	1
Smiley 3.0	67269 9	grey police	shiny	220	S	45 - 50	1
Smiley 3.0	67270 5	grey police	shiny	240	M	50 - 55	1
Smiley 3.0	67252 1	grey horse	shiny	220	S	45 - 50	1
Smiley 3.0	67253 8	grey horse	shiny	240	M	50 - 55	1
Smiley 3.0	67267 5	green robo	shiny	220	S	45 - 50	1
Smiley 3.0	67268 2	green robo	shiny	240	M	50 - 55	1
Smiley 3.0	67255 2	green nordic	shiny	220	S	45 - 50	1
Smiley 3.0	67256 9	green nordic	shiny	240	M	50 - 55	1
Smiley 3.0	67261 3	blue whale	shiny	220	S	45 - 50	1
Smiley 3.0	67262 0	blue whale	shiny	240	M	50 - 55	1
Smiley 3.0	67263 7	blue croco	shiny	220	S	45 - 50	1
Smiley 3.0	67264 4	blue croco	shiny	240	M	50 - 55	1



ACCESSOIRES DE CASQUE



**KIT HIVER
SCRAPER 3.0**



Page 284

**KIT HIVER
PEDELEC 2.0**



Page 284

KIT HIVER



Page 284

CASQUETTE



autumn black

Page 285

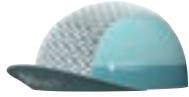

porto blue

Page 285



italian white

Page 285



adventure blue

Page 285

CAPUCHE



Page 285

CAPUCHE TOPLIGHT



Page 285

VISIÈRE



Gamechanger
TT & TRI

Page 286

**IN-VIZZ
ASCENT VISIÈRE**



Page 286

VISIÈRE



Hyban+

Page 286

VISIÈRE



Pedelec 2.0, Hyban
2.0, Hud-Y Ace

Page 287

VISIÈRE



Buteo

Page 287

LUMIÈRE USB



Hud-Y

Page 287

LUMIÈRE USB



Smiley 3.0,
Skurb Kid

Page 288

LUMIÈRE USB



Urban-l 3.0, Hyban
2.0, Youn-l 2.0

Page 288

**CAMERA MOUNT
MONTRAILER**



Page 288

**SPRAY NETTOYANT
PAD FRESH MS**

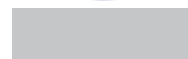

Page 289

QUIN SENSOR



Page 289

HOUSE ABUS



Page 289

**HOUSE DE CASQUE
PREMIUM**



Page 290

**SET D'AUTOCOLLANTS
RÉFLECTANTS**



Urban-l 3.0,
Hyban 2.0

Page 290



KIT HIVER SCRAPER 3.0



Kit d'hiver comprenant des oreillettes, un cache-vent et un bonnet en polaire

UTILISATION

- Bonnet molletonné avec protection des oreilles, qui remplace les mousses de protection habituelles dans le casque et protège du froid
- Cache-oreilles supplémentaire qui peut être attaché au casque

Article	EAN 4003318	couleur	Taille	Unité emb.
Kit Hiver Scrapper 3.0	81804 2	velvet black	M	1
Kit Hiver Scrapper 3.0	81805 9	velvet black	L	1
Kit Hiver Scrapper 3.0	81806 6	polar matt	M	1
Kit Hiver Scrapper 3.0	81807 3	polar matt	L	1
Kit Hiver Scrapper 3.0	81808 0	ultra blue	M	1
Kit Hiver Scrapper 3.0	81809 7	ultra blue	L	1
Kit Hiver Scrapper 3.0	81810 3	signal orange	M	1
Kit Hiver Scrapper 3.0	81811 0	signal orange	L	1

KIT HIVER PEDELEC 2.0



UTILISATION

- Cache-oreilles supplémentaire qui peut être attaché au casque

Article	EAN 4003318	couleur	Taille	Unité emb.
Kit Hiver Pedelec 2.0	83482 0		universelle	1

KIT HIVER



UTILISATION

- Bonnet rembourré équipé de protections pour les oreilles; il se fixe à l'intérieur du casque à la place du rembourrage standard et protège ainsi du froid.

Article	EAN 4003318	couleur	Taille	Unité emb.
Kit Hiver	48876 4	noir	M	1
Kit Hiver	48877 1	noir	L	1
Kit Hiver Smiley	48874 0	noir	S	1
Kit Hiver Smiley	48875 7	noir	M	1

CASQUETTE



autumn black



porto blue



italian white



adventure blue

UTILISATION

- 100% fabriqué en Italie
- Grand bandeau antibactérien de 20mm de largeur
- Bandeau élastique pour un ajustement optimal
- Matière douce et confortable
- Tissu spécifique pour un séchage rapide
- 65% polyester// 35% coton
- ★ • Partie centrale de la casquette en mailles de filet 100% polyester

Article	EAN 4003318	couleur	Taille	Tour de tête cm	Unité emb.
Casquette	96907 2	autumn black	S	51-55	1
Casquette	96047 5	autumn black	M/L	56-61	1
Casquette	96909 6	porto blue	S	51-55	1
Casquette	96048 2	porto blue	M/L	56-61	1
Casquette	96908 9	italian white	S	51-55	1
Casquette	96049 9	italian white	M/L	56-61	1
Casquette	96906 5	adventure blue	S	51-55	1
Casquette	96046 8	adventure blue	M/L	56-61	1

CAPUCHE



UTILISATION

- Matériau imperméable de couleur vive pour être visible par très mauvais temps et lorsque les conditions sont mauvaises
- Larges bandes réfléchissantes pour une meilleure visibilité pendant la nuit
- Equipée d'un élastique pour un parfait ajustage de la capuche à la taille du casque
- Capuche universelle jaune vif. Forme optimisée pour la plupart des casques, notamment ceux équipés d'une visière

Article	EAN 4003318	couleur	Taille	Unité emb.
Capuche	52151 5	jaune	universelle	1
Capuche	52154 6	noir	universelle	1

CAPUCHE TOPLIGHT



UTILISATION

- La capuche Toplight s'adapte sur tous les casques avec une lumière LED sur le haut
- Grâce à son tissu transparent, la lumière LED reste bien visible

Article	EAN 4003318	couleur	Taille	Unité emb.
Capuche Toplight	39849 0	noir	universelle	1

VISIÈRE GAMECHANGER TT/TRI



Clair

Fumée

chrome

UTILISATION

- Visière anti-buée grâce à une bonne ventilation, pour une vue toujours dégagée
- Les aimants dans le casque et sur le haut de la visière permettent un maintien ferme
- La grande visière permet une vision claire et dégagée vers l'avant
- Visière disponible en trois versions
- Le design et la conception de la visière font qu'elle s'intègre parfaitement dans le casque pour améliorer encore l'aérodynamisme

Article	EAN 4003318	couleur	Taille	Unité emb.
Visière claire	67936 0	claire	S	1
Visière claire	67937 7	claire	M	1
Visière claire	67938 4	claire	L	1
Visière fumée	67939 1	fumée	S	1
Visière fumée	67940 7	fumée	M	1
Visière fumée	67941 4	fumée	L	1
Visière chrome	67942 1	chrome	S	1
Visière chrome	67943 8	chrome	M	1
Visière chrome	67944 5	chrome	L	1

IN-VIZZ ASCENT VISIÈRE



Article	EAN 4003318	couleur	Taille	Unité emb.
Visière de rechange	38887 3	gris	universelle	1

HYBAN+ VISIÈRE



Article	EAN 4003318	couleur	Taille	Unité emb.
Hyban+ Fixation de visière	76435 6	gris	universelle	1
Hyban+ Visière	76436 3	claire	universelle	1
Fixation pour visière Hyban+	77325 9		universelle	1

VISIÈRE PEDELEC 2.0 & HYBAN 2.0



Article	EAN 4003318	couleur	Taille	Unité emb.
Fixation de visière Pedelec 2.0 / Hyban 2.0	82888 1	gris	universelle	1
Visière Pedelec 2.0 & Hyban 2.0	82889 8	claire	universelle	1
Visière Pedelec 2.0 & Hyban 2.0	82890 4		universelle	1

VISIÈRE BUTEO



UTILISATION

- Revêtement anti-buée
- Disponible avec visière claire, fumée ou effet miroir

Article	EAN 4003318	couleur	Taille	Unité emb.
Buteo Visière claire	68934 5	claire	universelle	1
Buteo Visière smoky	68935 2	smoky	universelle	1
Buteo Visière black chrome	68936 9	red chrome	universelle	1
Buteo Visière red chrome	68937 6	black chrome	universelle	1

LUMIÈRE USB HUD-Y



UTILISATION

- Lumière de recharge rechargeable pour le casque HUD-Y
- Augmente la visibilité dans l'obscurité et au crépuscule

Article	EAN 4003318	couleur	Taille	Unité emb.
Lumière USB HUD-Y	69446 2			1

LUMIÈRE USB SMILEY 3.0/SKURB KID



UTILISATION

- Lumière de rechange rechargeable pour casque Smiley 3.0 et Skurb Kid
- Augmente la visibilité dans l'obscurité et au crépuscule

Article	EAN 4003318	couleur	Taille	Unité emb.
Lumière USB Smiley 3.0/Skurb Kid	69445 5			1
Lumière USB Smiley 3.0/Skurb Kid	91108 8			1

LUMIÈRE USB URBAN- I 3.0/HYBAN 2.0/YOUN- I 2.0



UTILISATION

- Lumière de rechange rechargeable pour plusieurs modèles de casques
- Augmente la visibilité dans l'obscurité et au crépuscule

Article	EAN 4003318	couleur	Taille	Unité emb.
Lumière USB Urban-I 3.0/Hyban 2.0/Youn-I 2.0	88781 9			1

SUPPORT CAMÉRA MONTRAILER



Article	EAN 4003318	couleur	Taille	Unité emb.
Support Caméra MonTrailer	80492 2		universelle	1

SPRAY NETTOYANT - PAD FRESH MS



Article	EAN 4003318	couleur	Taille	Unité emb.
Spray Nettoyant - Pad Fresh MS	79188 8		30ml	1

QUIN SENSOR



Quin Sensor Slim

Quin Sensor

UTILISATION

- Capteurs de collision - cinq capteurs de contrôle évaluent constamment les données pendant l'utilisation et détectent les situations dangereuses
- IntelliSleep - si aucun mouvement n'est détecté pendant cinq minutes, la puce se met automatiquement en veille et économise de la batterie
- Bluetooth 5.0 - portée sans fil garantie de 20 mètres pour assurer une connexion stable avec le smartphone.
- Couplage automatique du casque QUIN avec le smartphone dès que la puce QUIN détecte un mouvement.
- Batterie rechargeable - mode de charge rapide de quatre heures via micro USB et jusqu'à un mois d'autonomie

Article	EAN 4003318	couleur	Taille	Unité emb.
Quin Sensor Slim	69319 9			1
Quin Sensor	68838 6			1

HOUSSE DE CASQUE PREMIUM



UTILISATION

- Sacoche de transport logotée pour casque
- Poche intérieure faite de tissu protecteur

Article	EAN 4003318	couleur	Taille	Unité emb.
Housse de casque premium	78592 4	noir	universelle	1

HOUSSE ABUS SPORTIV



Article	EAN 4003318	couleur	Taille	Unité emb.
Housse ABUS sportiv	68451 7	noir	universelle	1

SET D'AUTOCOLLANTS RÉFLECTEURS



Set d'autocollants
réflecteurs
URBAN-I 3.0



Set d'autocollants
réflecteurs
HYBAN 2.0

UTILISATION

- Ensemble de stickers réfléchissants pour casque afin d'être visible dans l'obscurité

Article	EAN 4003318	couleur	Taille	Unité emb.
Set d'autocollants réflecteurs HYBAN 2.0	88782 6	argent		1
Set d'autocollants réflecteurs URBAN-I 3.0	88783 3	argent		1



LUMINO



**LUMINO
NIGHT VEST**



yellow

Page 294

**LUMINO
DAY VEST**



red

Page 294

URBAN VEST



silver

Page 295

REFLEX VEST



yellow

Page 295

URBAN VEST KIDS



silver

Page 296

REFLEX VEST KIDS



yellow

Page 296

NIGHT COVER



yellow

Page 297

X-URBAN COVER



yellow/silver

Page 297

EASY MAGNET LIGHT



yellow

Page 298

LUMINO REFLEX BELT



yellow

Page 298

INDICATOR LIGHT



yellow

Page 299

ACTIVE BAR



yellow/black

Page 299

REFLEX WRAP



yellow

Page 300

REFLEX BAND



yellow

Page 300

RAINCAP



yellow

Page 301



black

Page 301

VESTE LUMINO NIGHT



VARIANTES



DONNÉES TECHNIQUES

- 100% polyester
- Matériau jaune fluorescent qui brille dès qu'il est éclairé
- Le matériau résistant aux UV reste lumineux même après des années d'utilisation
- Visibilité de 150 mètres la nuit et de 100 mètres le jour
- Avec feu arrière USB intégré composé de quatre puissantes LED rouges - rechargeable via mini-USB
- ★ La lumière LED éclaire jusqu'à 10 heures (fonction lumière continue et clignotante sur simple pression d'un bouton)
- La fermeture éclair de qualité assure une bonne tenue sur le corps
- Testé selon la norme européenne EN 1150:1999
- Dos allongé et bonne tenue

Article	EAN 4003318	couleur	Taille	Unité emb.
Lumino Night Vest yellow M	96020 8	jaune	M	1
Lumino Night Vest yellow L	96021 5	jaune	L	1
Lumino Night Vest yellow XL	96022 2	jaune	XL	1
Lumino Night Vest yellow XXL	96023 9	jaune	XXL	1
Lumino Night Vest yellow XXXL	96024 6	jaune	XXXL	1

LUMINO DAY VEST



DONNÉES TECHNIQUES

- 100% polyester
- Matériau rouge fluorescent qui brille dès qu'il est éclairé
- Le matériau résistant aux UV brille même après des années d'utilisation.
- Quatre bandes hautement réfléchissantes pour une très bonne visibilité de nuit, mais aussi une très bonne visibilité de jour.
- Visibilité de 150 mètres la nuit et de 100 mètres le jour
- ★ La fermeture éclair de qualité assure une bonne tenue sur le corps
- Testé selon la norme européenne EN 17353:2020 (AB3)
- Dos allongé et bonne tenue

Article	EAN 4003318	couleur	Taille	Unité emb.
Lumino Day Vest red M	96026 0	rouge	M	1
Lumino Day Vest red L	96027 7	rouge	L	1
Lumino Day Vest red XL	96028 4	rouge	XL	1
Lumino Day Vest red XXL	96029 1	rouge	XXL	1
Lumino Day Vest red XXXL	96031 4	rouge	XXXL	1

LUMINO URBAN VEST



DONNÉES TECHNIQUES

- 100% polyester
- Gilet haute visibilité entièrement réfléchissant : La quasi-totalité de la surface du gilet de haute visibilité est éclairée par les phares.
- Rayures coordonnées en couleur
- Visibilité de 150 mètres dans l'obscurité
- Testé selon la norme européenne EN 17353:2020 (B3)
- La fermeture éclair de marque assure une bonne tenue sur le corps
- Dos allongé et bonne tenue

Article	EAN 4003318	couleur	Taille	Unité emb.
Lumino Urban Vest silver M	69937 5	argent	M	1
Lumino Urban Vest silver L	69938 2	argent	L	1
Lumino Urban Vest silver XL	69944 3	argent	XL	1
Lumino Urban Vest silver XXL	90943 6	argent	XXL	1
Lumino Urban Vest silver XXXL	96034 5	argent	XXXL	1

LUMINO REFLEX VEST



DONNÉES TECHNIQUES

- 100% polyester
- Matériau jaune fluorescent qui brille dès qu'il est éclairé
- Le matériau résistant aux UV brille même après des années d'utilisation.
- Quatre bandes hautement réfléchissantes pour une très bonne visibilité de nuit, mais aussi une très bonne visibilité de jour.
- Visibilité de 150 mètres la nuit et de 100 mètres le jour
- Très bonne tenue grâce à la fermeture éclair de marque qui fonctionne bien
- Testé selon la norme européenne EN 17353:2020 (AB3)
- Dos allongé et bonne tenue

Article	EAN 4003318	couleur	Taille	Unité emb.
Lumino Reflex Vest yellow M	69928 3	jaune	M	1
Lumino Reflex Vest yellow L	69935 1	jaune	L	1
Lumino Reflex Vest yellow XL	69936 8	jaune	XL	1
Lumino Reflex Vest yellow XXL	90942 9	jaune	XXL	1
Lumino Reflex Vest yellow XXXL	96033 8	jaune	XXXL	1

LUMINO URBAN VEST



DONNÉES TECHNIQUES

- 100% polyester
- Gilet haute visibilité entièrement réfléchissant : La quasi-totalité de la surface du gilet de haute visibilité est éclairée par les phares.
- Rayures coordonnées en couleur
- Visibilité de 150 mètres dans l'obscurité
- Testé selon la norme européenne EN 17353:2020 (B3)
- La fermeture éclair de qualité assure une bonne tenue sur le corps
- Dos allongé et bonne tenue

Article	EAN 4003318	couleur	Taille	Unité emb.
Lumino Urban Vest Kids argenté S	69948 1	argent	S	1
Lumino Urban Vest Kids argenté M	69949 8	argent	M	1
Lumino Urban Vest Kids argenté L	69950 4	argent	L	1

LUMINO REFLEX VEST



DONNÉES TECHNIQUES

- 100% polyester
- Matériau jaune fluorescent qui brille dès qu'il est éclairé
- Le matériau résistant aux UV brille même après des années d'utilisation.
- Quatre bandes hautement réfléchissantes pour une très bonne visibilité de nuit, mais aussi une très bonne visibilité de jour.
- Visibilité de 150 mètres la nuit et de 100 mètres le jour
- La fermeture éclair de qualité assure une bonne tenue sur le corps
- Testé selon la norme européenne EN 17353:2020 (AB3)
- Dos allongé et bonne tenue

Article	EAN 4003318	couleur	Taille	Unité emb.
Lumino Reflex Kids jaune S	69945 0	jaune	S	1
Lumino Reflex Kids jaune M	69946 7	jaune	M	1
Lumino Reflex Kids jaune L	69947 4	jaune	L	1

LUMINO NIGHT COVER



DONNÉES TECHNIQUES

- Housse de pluie pour sac à dos avec feu arrière USB intégré - composé de quatre puissantes LED rouges
- Fonction de lumière continue et clignotante par simple pression d'un bouton
- Rechargeable via mini USB
- La lumière LED brille jusqu'à 10 heures (après la charge)
- 2 sangles élastiques réglables pour s'adapter au sac à dos
- Visibilité de 150 mètres la nuit et de 100 mètres le jour
- Adapté au temps pluvieux grâce à un extérieur entièrement soudé et étanche
- Housse de pluie imperméable

Article	EAN 4003318	couleur	Taille	Unité emb.
Lumino Night Cover jaune	69954 2	jaune		1

LUMINO X- URBAN COVER



DONNÉES TECHNIQUES

- Matériau jaune fluorescent qui brille dès qu'il est éclairé
- Bandes hautement réfléchissantes pour une très bonne visibilité de nuit, mais aussi une très bonne visibilité de jour.
- Visibilité de 150 mètres la nuit et de 100 mètres le jour
- 2 sangles élastiques réglables pour s'adapter au sac à dos
- Adapté au temps pluvieux grâce à un extérieur entièrement soudé et étanche
- Housse de pluie imperméable

Article	EAN 4003318	couleur	Taille	Unité emb.
Lumino X-Urban Cover jaune/argenté	69955 9	jaune/argent		1

LUMINO EASY MAGNET LIGHT



DONNÉES TECHNIQUES

- Fonction lumière permanente et lumière clignotante par simple pression sur un bouton
- Rechargeable via mini USB
- Matériau brillant de haute qualité, jaune avec 4 LED rouges
- La bande lumineuse peut être facilement fermée à l'aide de la fermeture magnétique
- La lumière LED brille jusqu'à 10 heures (après la charge)
- Adapté au temps pluvieux grâce à un extérieur entièrement soudé et étanche
- Visibilité de 150 mètres la nuit et de 100 mètres le jour
- Testé selon la norme européenne EN 13356:2001

Article	EAN 4003318	couleur	Taille	Unité emb.
Lumino Easy Magnet Light jaune	69960 3	jaune		1

CEINTURE LUMINO REFLEX



DONNÉES TECHNIQUES

- 100% polyester
- Matériau jaune fluorescent qui brille dès qu'il est éclairé
- Bande fortement réfléchissante pour une très bonne visibilité de nuit, mais aussi de jour.
- Le matériau résistant aux UV reste lumineux même après des années d'utilisation
- Visibilité de 150 mètres la nuit et de 100 mètres le jour
- ★ Réglage flexible de la taille grâce à quatre points de réglage

Article	EAN 4003318	couleur	Taille	Unité emb.
Lumino Reflex Belt yellow	96025 3	jaune		1

LUMINO INDICATOR LIGHT



DONNÉES TECHNIQUES

- Fonction de lumière continue et clignotante par simple pression d'un bouton
- Pile remplaçable CR2032 incluse
- Matériau brillant de haute qualité, jaune avec 4 LED rouges puissantes
- Avec une fermeture Velcro pratique permettant de l'attacher à divers objets
- Fonctionne jusqu'à 100 heures
- Adapté au temps pluvieux grâce à un extérieur entièrement soudé et étanche

Article	EAN 4003318	couleur	Taille	Unité emb.
Lumino Indicator Light jaune	69958 0	jaune		1

LUMINO ACTIVE BAR



DONNÉES TECHNIQUES

- Fonction de lumière continue et clignotante par simple pression d'un bouton
- Pile remplaçable CR2032 incluse
- Fonctionne jusqu'à 100 heures
- Adapté au temps pluvieux grâce à un extérieur entièrement soudé et étanche
- Testé selon la norme européenne EN 13356:2001
- Visibilité de 150 mètres la nuit et de 100 mètres le jour

Article	EAN 4003318	couleur	Taille	Unité emb.
Lumino Active Bar jaune/noir	69957 3	jaune/noir		1

LUMINO REFLEX WRAP



DONNÉES TECHNIQUES

- Matériau jaune fluorescent qui brille dès qu'il est éclairé
- Deux bandes hautement réfléchissantes pour une très bonne visibilité de nuit, mais aussi une très bonne visibilité de jour.
- Matériau résistant aux UV (conforme aux exigences de la norme européenne EN2471), brille même après des années d'utilisation.
- Visibilité de 150 mètres la nuit et de 100 mètres le jour
- Flexible grâce à la fermeture Velcro (de 82 à 108 cm de circonférence environ)

Article	EAN 4003318	couleur	Taille	Unité emb.
Lumino Reflex Wrap jaune	69952 8	jaune		1

BANDE LUMINO REFLEX



DONNÉES TECHNIQUES

- Bande réfléchissante à enrouler
- Matériau jaune fluorescent qui brille dès qu'il est éclairé
- Le matériau résistant aux UV reste lumineux même après des années d'utilisation
- Dos en velours doux
- 2 bandes réfléchissantes incluses dans l'emballage
- Idéal pour une fixation au bras, à la cheville ou même au panier du vélo
- ★ En tant que bande de pantalon, elle protège également le pantalon de la saleté provenant du plateau ou de la chaîne

Article	EAN 4003318	couleur	Taille	Unité emb.
Bande Lumino Reflex jaune	96035 2	jaune		1

CAPUCHE



VARIANTES



yellow



black

DONNÉES TECHNIQUES

- Matériau imperméable de couleur vive pour être visible par très mauvais temps et lorsque les conditions sont mauvaises
- Larges bandes réfléchissantes pour une meilleure visibilité pendant la nuit
- Equipée d'un élastique pour un parfait ajustage de la capuche à la taille du casque

Article	EAN 4003318	couleur	Taille	Unité emb.
Capuche	52151 5	jaune	universelle	1
Capuche	52154 6	noir	universelle	1

AMÉNAGER LE MAGASIN AVEC SUCCÈS

Du point de vue de la psychologie de vente, la manière dont vous aménagez votre magasin est décisive pour votre succès commercial. Nous vous aidons à aménager votre surface de vente de manière conviviale. Ainsi, vous assurez des ventes réussies non seulement aujourd'hui, mais aussi à l'avenir. Car vos clients reviendront toujours.

1. SE DÉMARQUER

Assurez-vous que votre magasin se distingue de la masse et faites en sorte que vos clients se sentent à l'aise dans votre magasin grâce à une atmosphère confortable.

2. CONVAINCRE PAR LA QUALITÉ

Une longue expérience, des processus de développement bien pensés et des matériaux de haute qualité sont décisifs aussi bien pour les produits eux-mêmes que pour les moyens de présentation.

ABUS vous propose les deux.

3. SE SOUVENIR

Créez des expériences qui vont au-delà de la simple mise à disposition et de la vente de marchandises. Toucher, essayer - partir à la découverte. C'est là que réside votre avantage, surtout par rapport au commerce en ligne.



NOUS VOUS ACCOMPAGNONS DANS LA VENTE

Vos besoins en tant que revendeur sont très importants pour nous. Notre nouveau système de mobilier est donc conçu pour refléter au mieux la marque ABUS, tout en vous laissant la liberté pour votre stratégie de vente et de vos surfaces commerciales.

CONCEPTION MODULAIRE :

Hauteur, largeur, emplacement du produit, placement dans la pièce, dans un coin ou contre le mur : C'est vous qui décidez !

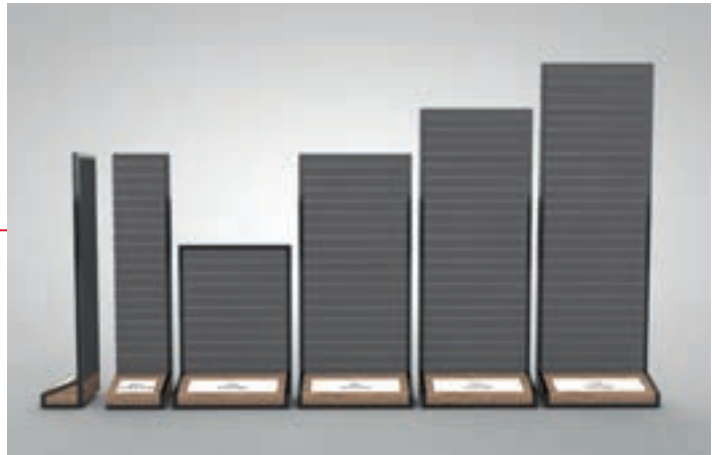

NOMBREUX MODULES :

Attirer l'attention, catégoriser, informer - combinez les outils selon vos besoins.

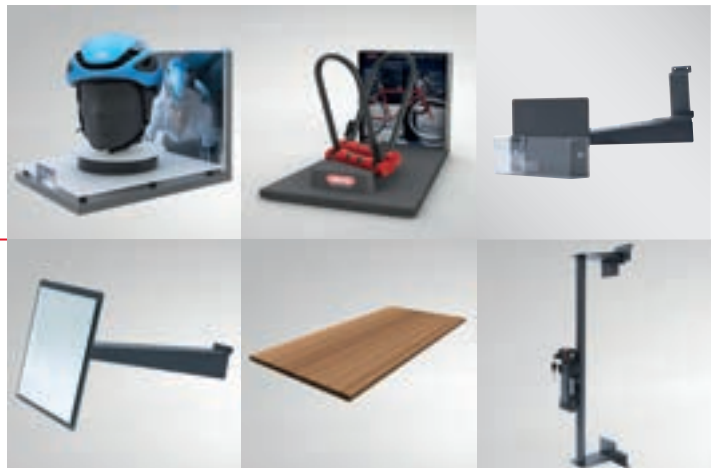

DESIGN MODERNE :

Des éléments en métal et en bois combinés dans un look épuré „fait-main“ - le concept de design de votre magasin ne sera pas perturbé.

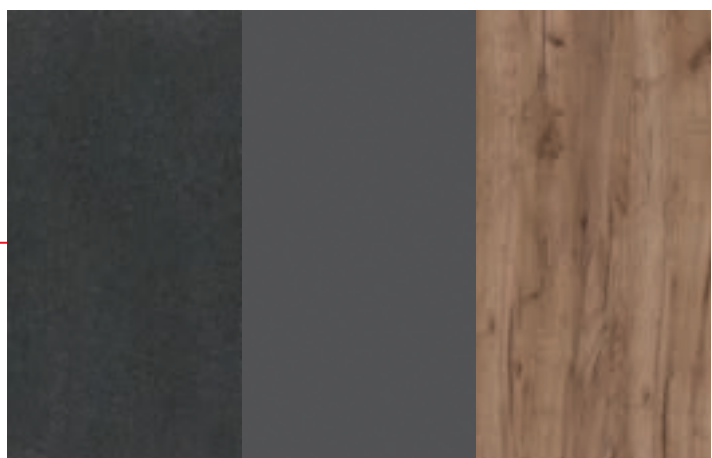

Revêtement en
poudre DB703
structure fine

Gris graphite
Kronospan décor
0162

Chêne tabac
artisanal
Décor Kronospan
K004

CRÉEZ DÈS MAINTENANT VOTRE ESPACE DE VENTE PERSONNEL ABUS !

AFFICHAGE MURAL

Exploitez pleinement la hauteur et la largeur de vos murs pour mettre en valeur les casques de vélo ABUS.



DIMENSIONS DU PRÉSENTOIR MURAL

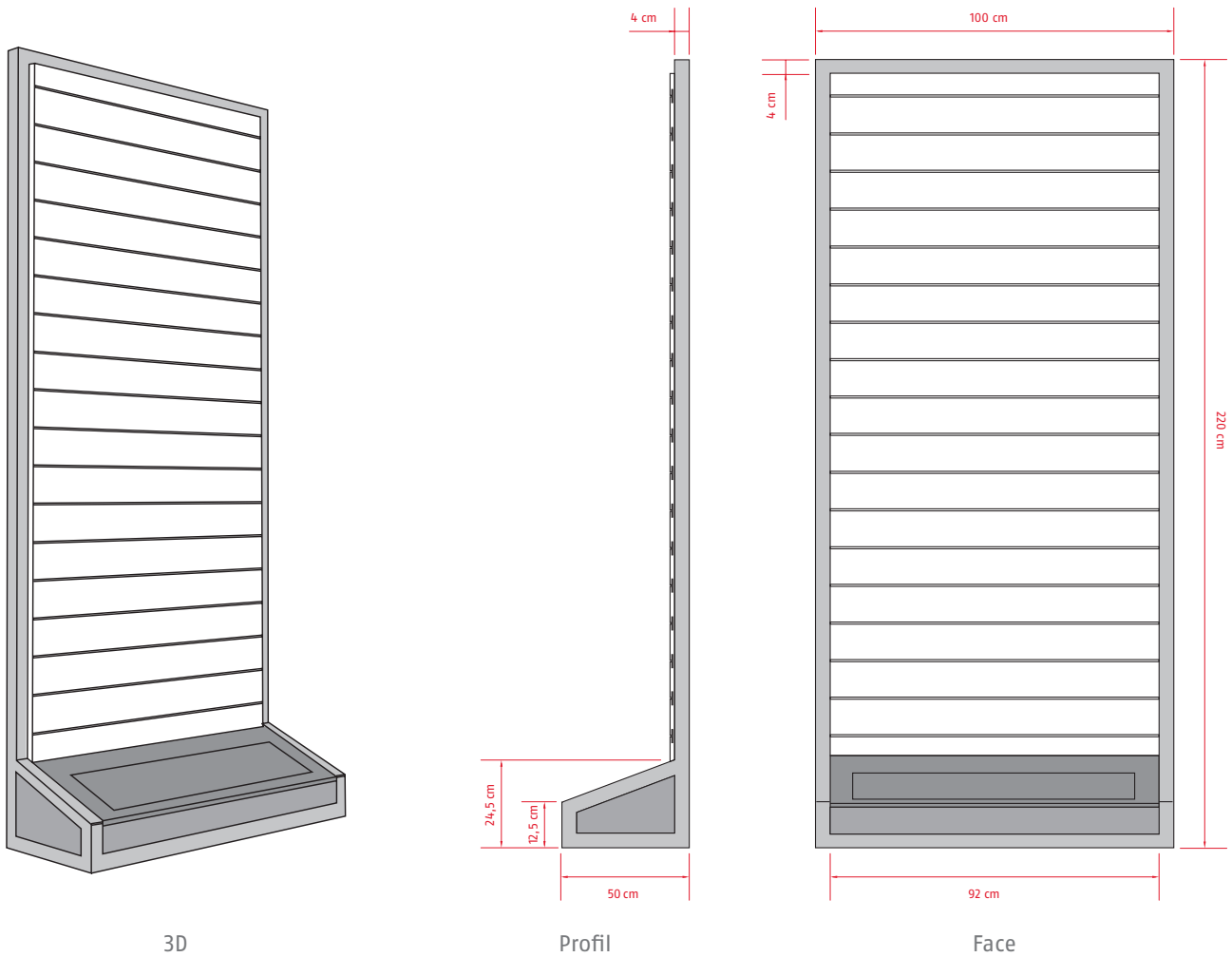

3D

Profil

Face

CARACTÉRISTIQUES PRÉSENTOIR MURAL:

Disponible en largeur de 100 cm ou 50 cm

La hauteur peut être augmentée par paliers de 40 cm avec des entretoises supplémentaires

Mur à lamelles avec possibilité d'alimentation électrique pour l'éclairage, etc.



Base en aspect bois avec incrustations interchangeables

En option avec couvercle amovible (peut être utilisé comme goulotte/ espace de rangement)

Possibilité d'utiliser des éléments d'image sur toute la surface

PRÉSENTOIR AUTOPORTANT

Développez et structurez la catégorie des casques avec des présentoirs autoportants - par exemple pour les nouveaux produits et les offres spéciales.



DIMENSIONS DU PRÉSENTOIR AUTONOME

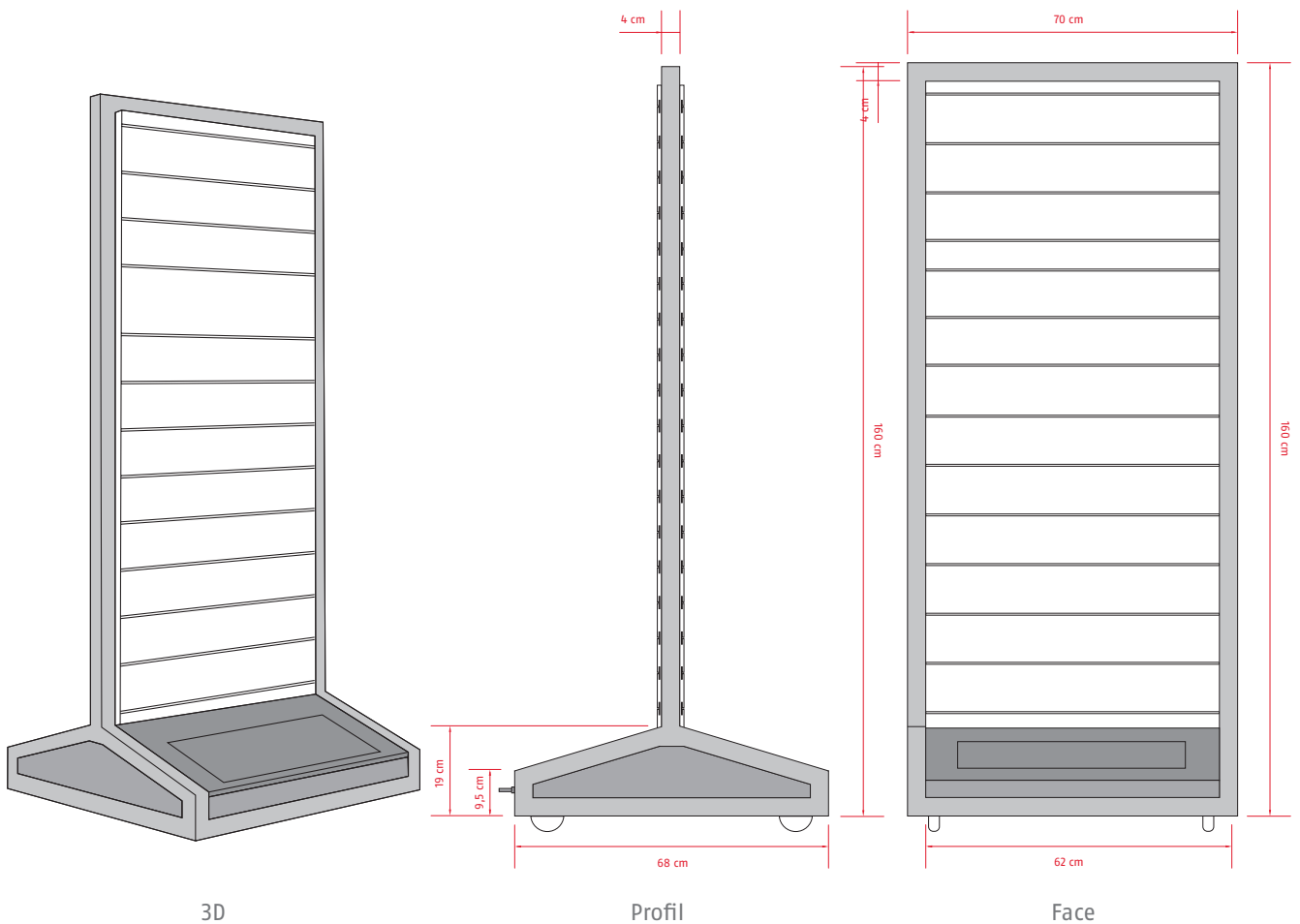

CARACTÉRISTIQUES PRÉSENTOIR AUTONOME:

Utilisation/équipement double face possible

Hauteur extensible de 140 cm, 180 cm, et 200 cm
Largeur: 70 cm, profondeur: 68 cm

Mur à lamelles avec possibilité d'alimentation électrique pour l'éclairage, etc.



Base en aspect bois avec incrustations interchangeables

En option avec couvercle amovible (peut être utilisé comme goulotte/ espace de rangement)

Roulettes en option pour déplacer facilement le présentoir

COMPLÉMENTS

Développez votre affichage avec divers modules complémentaires pour un placement et des expériences-produits personnalisés.

ORIENTATION

Rendez la marque ABUS visible de loin et catégorisez les casques pour vélos afin que vos clients s'y retrouvent plus facilement.

PRODUIT

Combinez différents crochets, supports et surligneurs pour présenter votre gamme ABUS d'une manière peu encombrante et accrocheuse.

EXTRAS

Utilisez des extras pour compléter l'expérience-produit de votre clientèle et accélérer la décision d'achat.

LES AJOUTS SUIVANTS SONT DISPONIBLES POUR LES CASQUES DE VÉLO ET ANTIVOLS DE VÉLO :



Logo ABUS
Une face, à suspendre (50 cm)



Plaques métallique et feuille magnétique pour la catégorie Route, Offroad



Cadre extensible pour photos



Étagère en bois
(50 cm et 100 cm)

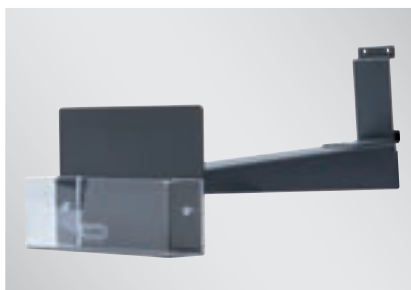

Porte-brochures



Éclairage

LES AJOUTS SUIVANTS SONT DISPONIBLES POUR LES CASQUES DE VÉLO :

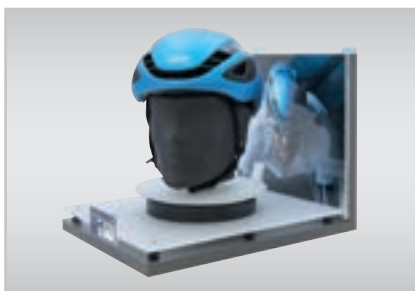

Tête de modèle de surligneur, rotative et éclairée



Véritable miroir



Base en aspect bois avec incrustations interchangeables

LES AJOUTS SUIVANTS SONT DISPONIBLES POUR LES ANTIVOLS DE VÉLO :

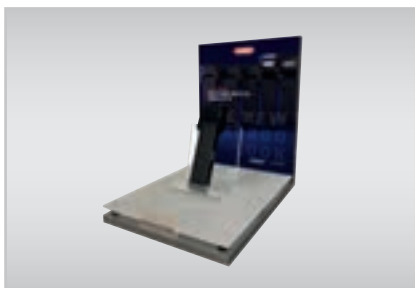

Attachement de surligneur Bordo



Attachement de surligneur U-lock



Testeur d'antivol, double hauteur

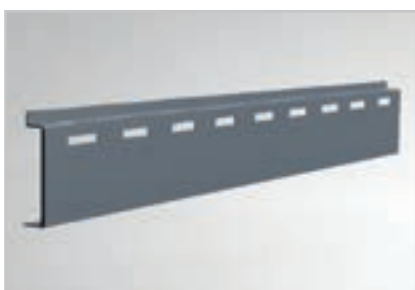

Poutre transversale lourde
(50 cm et 100 cm)

OPTIMISATION - SIGNALÉTIQUE - ÉMOTION - EXPÉRIENCE LE TOUT EN HARMONIE

Notre nouveau système de présentation offre de nombreuses possibilités de combinaison.
Vous pouvez choisir et équiper vos présentoirs en fonction de votre assortiment et de vos locaux.



FONCTIONNALITÉ ET L'ÉMOTION EN HARMONIE

Bien combinés, les différents éléments offrent de nombreux avantages.



Parfait équilibre entre la proportion de produits et d'éléments visuels adaptés à l'assortiment

Large choix d'images éclairées pour les cadres en toile tendue

Facilité d'orientation du client grâce aux balisages de linéaire par catégorie de produits



Affichages interchangeables avec des informations sur les produits pour guider le client

Espace de rangement dans le socle pour entreposer proprement des produits

AUTRES PRÉSENTOIRS ET SUPPORTS PUBLICITAIRES

Équipez votre magasin d'autres éléments ABUS en fonction de vos besoins. Qu'il s'agisse de présentoirs ou de supports publicitaires généraux, nous vous proposons un choix large et de qualité pour soutenir au mieux les ventes.

GÉNÉRAL



MAISON DE JARDIN

B: 225cm, H: 120cm, T: 200cm



DRAPEAU DE PLAGE

H: 200 cm



POUR LES CASQUES



PRÉSENTOIR MODULAIRE

Présentoir de casques avec supports à fixation variable pour atteindre jusqu'à 30 casques
H: 200 cm

PAILLASSON

B: 120 cm, H: 75 cm

POUR LES ANTIVOLS



PLAQUE DE PORTE

770A SmartX
B: 23 cm, H: 28 cm



DEMO-DISPLAY

6500A SmartX
B: 24 cm, H: 30 cm



SI VOUS ÊTES INTÉRESSÉ, N'HÉSITEZ PAS À CONTACTER VOTRE REPRÉSENTANT COMMERCIAL OU NOTRE PERSONNEL DE BUREAU.

PLV ONEKEY



AUTOCOLLANT DE FENETRE
B: 28 cm, H: 73 cm

STOP-RAYON
B: 10 cm, H: 9 cm



ACCROCHE GUIDON
B: 10 cm, H: 29 cm



TAPIS DE SOURIS
B: 42 cm, H: 30 cm

ROLL-UP

B: 85 cm, H: 215 cm



PLV LUMINO



PRESENTOIR LUMINO
B: 40 cm, H: 185 cm,
T: 40 cm



PRESENTOIR LUMINO
B: 65 cm, H: 54 cm,
T: 21 cm

PLV VTT



PLV POUR BROCHE

B: 26 cm, H: 26 cm

POSTER FORMAT A3

B: 30 cm, H: 29 cm



ACCROCHE GUIDON

B: 11 cm, H: 25 cm

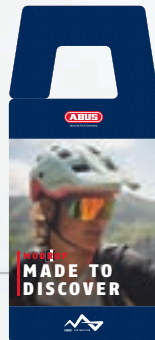

TAPIS DE SOURIS

B: 59 cm, H: 20 cm



TOTEM MODROP

B: 50 cm, H: 215 cm, T: 42 cm

SI VOUS ÊTES INTÉRESSÉ, N'HÉSITEZ PAS À CONTACTER VOTRE REPRÉSENTANT COMMERCIAL OU NOTRE PERSONNEL DE BUREAU.

INDEX

Article	Page	Article	Page	Article	Page
Antivols		Antivols		Supports d'antivols et sacoches	
64 TITALIUM™	141	IVEN Chain 8210	54	Bandes de serrage LH	160
70 & 70IB	142	IVEN Steel-0-Flex™ 8200	75	Basico ST 5200	162
145	140	IVERA Cable 7220	92	Chain Bag ST 2012	156
147TSA	143	IVERA Chain 7210	55	EaZy KF™	149
402	25	IVERA Chain 7210 Color	55	Fidlock FL	158
440 Alarm	22	IVERA Steel-0-Flex™ 7200	76	Fidlock TexFL	158
770A SmartX™	15	IVY Chain 9210	49	GH 50	150
1200 Web	67	IvyTex Adapter Chain	111	IVERA RBU	155
1500 Web	67	KeyGarage™ 767	139	KF	160
1850	132	KeyGarage™ 787	137	Oryde ST 2085	161
3406C	97	KeyGarage™ 787 BIG	136	Oryde ST 2100	162
3406K	97	KeyGarage™ 787 BIG LED	136	Oryde ST 2200	161
3506C	91	KeyGarage™ 787 LED	137	Oryde ST 2250	161
3506K	91	KeyGarage™ 797	138	Quick Store QST	156
4408C	96	KeyGarage™ 797 LED	138	QuickSnap	159
4408K	96	KeyGarage™ Smart 787	135	QuickSnap RBU	159
4650S / SL	107	KeyGarage™ Smart 797	135	Saddlefix QST	156
4650X / XL	106	Microflex 6615K	81	Saddlefix SH SF	151
6206K Goose Lock	71	Numerino 5410C	95	SCLL	157
6806K Classic	62	Numero 5510C	89	Selle Royale (5C,5K,6C,6K)	158
8808C	53	PHANTOM™ 8950	86	SH 5700 BORDO™	153
ACH 2.0 Adaptor Chain	110	PHANTOM™ 8960	78	SH 5700 uGrip BORDO™ BIG	153
ADAPTOR CABLE	110	Primo 5410K	95	SH 6000 BORDO™	152
AFS625	133	Primo 5510K	89	SH 6000 BORDO™ Big	153
Alarmbox 2.0	122	PRO AMPARO 4750 S / SL	105	SH 6055 BORDO™ Lite	154
Alarmbox RC	123	PRO AMPARO 4750 X / XL	104	SH 6500 BORDO™ BIG	152
Booster 6512K	88	PRO SHIELD XPlus™ 5955	102	SH 6500K BORDO™	151
BORDO GRANIT XPlus™ 6500	32	PRO TECTIC™ 4960	108	SH B	148
BORDO GRANIT™ 6500K	33	PS88	133	SH FL	152
BORDO GRANIT™ 6500KA	31	Racer 6412K	94	SH6500A SmartX™	151
BORDO™ 6000C	38	Raydo Pro 1450	87	Shackle Clamp	150
BORDO™ 6000C LED	39	SHIELD XPlus™ 5755L	103	Snap Cage	157
BORDO™ 6000K	35	Sportflex 2504	128	SR 6055 BORDO™	154
BORDO™ 6000KA	34	Star 4508C	90	ST 5700 uGrip BORDO™	155
BORDO™ 6000PZ	36 - 37	Star 4508K	90	ST 5850/5650/4960	157
BORDO™ 6500A SmartX	30	Steel-0-Chain™ 4804C	66	ST 5950 2.0	162
BORDO™ Lite 6055C	43	Steel-0-Chain™ 4804C SYMBOLS	66	ST 6000 BORDO™	154
BORDO™ Lite 6055K	42	Steel-0-Chain™ 4804K	65	ST 6000 BORDO™ Big	155
Catena 6806K	59	Steel-0-Chain™ 5805C	64	TexKF Mini	159
Catena 6806K Color	60	Steel-0-Chain™ 5805K	63	UGH 02	150
Catena 6806K Neon	59	Steel-0-Chain™ 8807K	56	URB	160
Catena 6806K Reflective	61	Steel-0-Chain™ 9808K	52	USH 540 / 470 / 460 / 440A	149
Centuro 860	77	Steel-0-Chain™ 9809K	51	USKF	149
Chain Claw 10	121	Steel-0-Flex™ 950	74		
CityChain™ 1010	50	Steel-0-Flex™ Raydo Pro 1460	79		
Cobra™	132	Steel-0-Flex™ Tresor 1360	80		
Combiflex™	129	TECTIC™ 496	109		
Combiflex™ Adventure	130	Tresor 1385	57		
Combiflex™ Travelguard	130	Tresor 1385 Color	58		
Combiloop 205	131	Tresor 6412C	94		
Diskus® 20	143	Tresor 6512C	88		
Diskus® 24IB	142	Tresorflex 6615C	81		
Facilo 32	24	uGrip BORDO™ 5700 Combo	41		
GRANIT CityChain XPlus™ 1060	48	uGrip BORDO™ 5700K	40		
GRANIT XPlus™ 540	17	Ultimate 420	20		
GRANIT™ 460	21	Ultra 410	23		
GRANIT™ Plus 470	19	Ultra 410 Combo	23		
GRANIT™ Plus 640	18	WA 50	127		
GRANIT™ Power 58	14	WBA 60	127		
GRANIT™ WBA 100	126	WCH90	125		
GRANIT™ WBA 75	126				

INDEX

Article Casques	Page	Article Lumino	Page
Aduro 2.0	256 - 257	Active Bar	299
Airbreaker	182 - 183	Easy Magnet Light	298
AirDrop	206 - 207	Indicator Light	299
Aventor QUIN	196 - 197	Lumino Day Vest	294
Buteo	216 - 217	Lumino Night Vest	294
BUTEO Visière	287	Lumino Reflex Belt	298
Camera Mount MonTrailer	288	Night Cover	297
Capuche	285	Raincap	301
Capuche Toplight	285	Reflex Band	300
CliffHanger	208 - 209	Reflex Vest	295
GameChanger	188 - 189	Reflex Vest Kids	296
GameChanger TRI	186 - 187	Reflex Wrap	300
GameChanger TT	184 - 185	Urban Vest	295
GameChanger TT&Tri Visor	286	Urban Vest Kids	296
Housse ABUS	289	X-Urban Cover	297
Housse ABUS sportif	290		
HUD-Y	234 - 235		
HUD-Y ACE	232 - 233		
Hyban 2.0	246 - 247		
Hyban 2.0 ACE	244 - 245		
Hyban 2.0 LED	242 - 243		
Hyban+ Visière	286		
In-Vizz Ascent Visière	286		
Kit Hiver	284		
Kit Hiver Pedelec 2.0	284		
Kit Hiver Scraper 3.0	284		
Lumière USB	288		
Lumière USB HUD-Y	287		
Lumière USB Smiley 3.0/Skurb Kid	288		
Macator	200 - 201		
MoDrop	212 - 213		
MoTrip	214 - 215		
MountZ	270 - 271		
Moventor 2.0	210 - 211		
Pedelec 1.1	230 - 231		
Pedelec 2.0	228 - 229		
Pedelec 2.0 ACE	226 - 227		
Pedelec 2.0/Hyban 2.0/HUD-Y ACE Visière	287		
PowerDome	194 - 195		
PowerDome ACE	192 - 193		
QUIN Sensor	289		
Race Cap	285		
Scraper 3.0	254 - 255		
Scraper 3.0 ACE	252 - 253		
Set d'autocollants réflecteurs	290		
Skurb	250 - 251		
Skurb ACE	248 - 249		
Skurb Kid	272 - 273		
Smiley 3.0	278 - 279		
Smiley 3.0 ACE LED	274 - 275		
Smiley 3.0 LED	276 - 277		
Spray Nettoyant - Pad Fresh MS	289		
StormChaser	190 - 191		
Urban-I 3.0	238 - 239		
Urban-I 3.0 ACE	236 - 237		
Viantor	198 - 199		
YouDrop	264 - 265		
YouDrop FF	262 - 263		
Youn-I 2.0	266 - 267		
Youn-I ACE	240 - 241		
Youn-I MIPS	268 - 269		

CARTE DE NOS COMMERCIAUX PAR SECTEUR

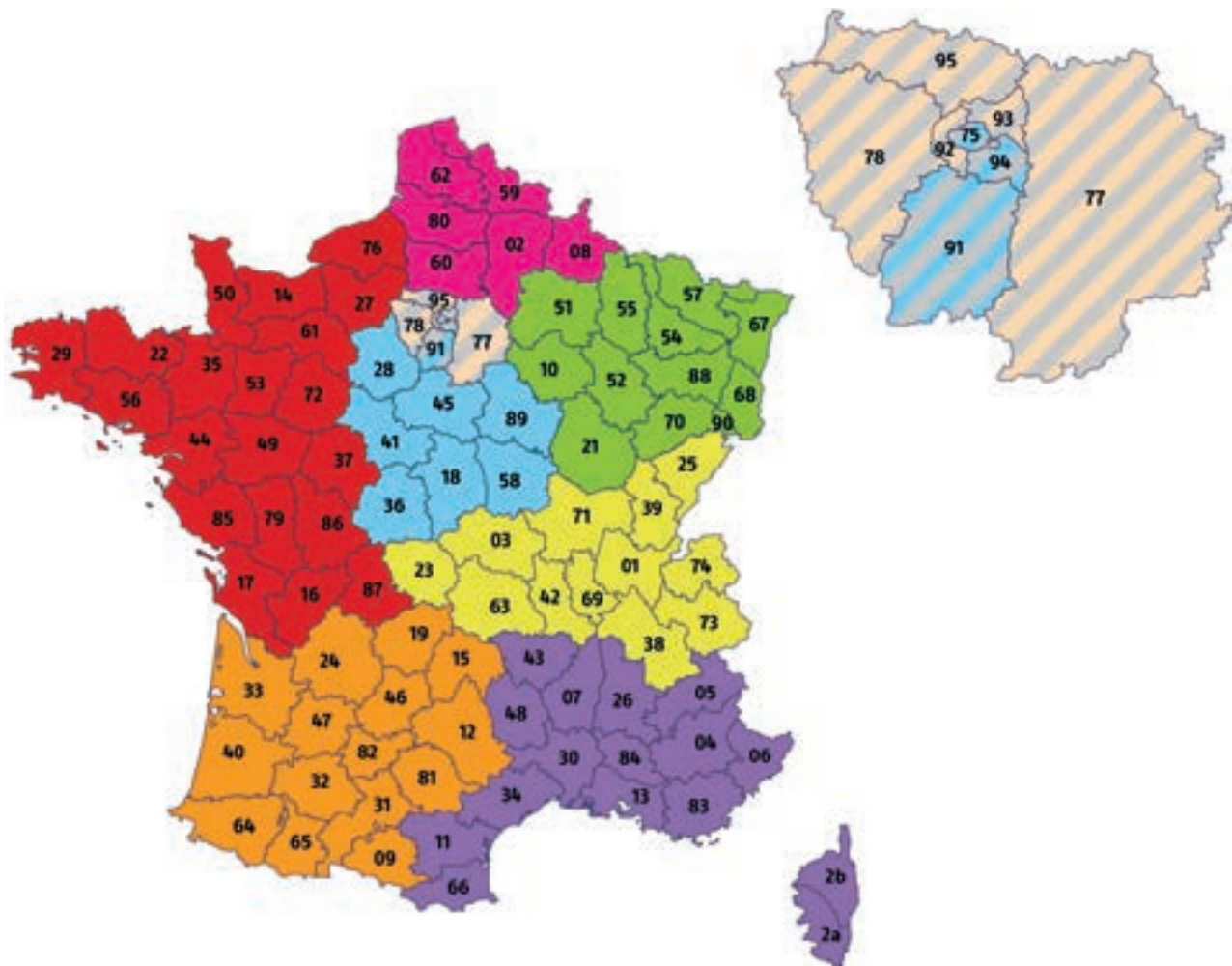

● SECTEUR IDF ET CENTRE
Thierry JEANSON
 Tél. : 06 17 82 47 09
 Mail : thierry.jeanson@abus.fr
 Assistante service client :
 Virginie PINARDEL - Tél. : 01 49 61 67 68

● SECTEUR OUEST
Germain LAMBERT
 Tél. : 06 17 82 47 22
 Mail : germain.lambert@abus.fr
 Assistante service client :
 Laetitia TELLEZ - Tél. : 01 49 61 23 20

● SECTEUR IDF
Sabrina HARROSH
 Tél. : 06 21 35 80 02
 Mail : sabrina.harrosh@abus.fr
 Assistante service client :
 Manon UHEL - Tél. : 01 49 61 67 77

● SECTEUR NORD-EST
David PFENNIG
 Tél. : 06 17 82 47 12
 Mail : david.pfennig@abus.fr
 Assistante service client :
 Émeline PHIBEL - Tél. : 01 49 61 68 06

● SECTEUR CENTRE-EST
Pierre RUDY
 Tél. : 06 17 82 47 28
 Mail : pierre.rudy@abus.fr
 Assistante service client :
 Service client - Tél. : 01 49 61 23 16

● SECTEUR NORD
Damien MONNIER
 Tél. : 06 21 35 80 13
 Mail : damien.monnier@abus.fr
 Assistante service client :
 Virginie PINARDEL - Tél. : 01 49 61 67 68

● SECTEUR SUD-OUEST
Séverine JOUAN CHAVANT
 Tél. : 06 17 82 46 75
 Mail : severine.jouan@abus.fr
 Assistant service client :
 Virgile KOUAO - Tél. : 01 49 61 23 17

● SECTEUR SUD-CENTRE / SUD-EST
Jean-François GALFRE
 Tél. : 06 17 82 47 35
 Mail : jean-francois.galfre@abus.fr
 Assistant service client :
 Virgile KOUAO - Tél. : 01 49 61 23 17

● SECTEUR IDF (Uniquement Moto)
Jérôme YON
 Tél. : 06 23 91 31 69
 Mail : jerome.yon@abus.fr
 Assistante service client :
 Virginie PINARDEL - Tél. : 01 49 61 67 68

POUR PASSER VOS COMMANDES :

Mail : serviceclients@abus.fr

OU

Web : partner-fr.abus.com



Security Tech Germany



© ABUS | FRANCE S.A.S
abus.com

15, voie de la Gravière
94290 Villeneuve le Roi
France
contact@abus-france.fr
+33 (0)1 49 61 67 67

Imprimé sur du papier issu de forêts durables. Sous réserve de modifications techniques et de présentation.
Nous déclinons toute responsabilité pour des erreurs d'impression. © ABUS 2022



KAT MoSi 2023 Gesamt
FR ohne Preise

