



Security Tech Germany



OCCUPATIONAL SAFETY

LOCKOUT / TAGOUT WITH SYSTEM

Is your company ready for LoTo?



PROTECT THE LIVES OF YOUR EMPLOYEES

Ensure a safe working environment!

With a complete lockout/tagout system, you can ensure that your employees are able to perform maintenance work without worrying about their safety or fearing for their lives. This provides added security, which not only helps to prevent accidents caused by the unexpected start-up of machinery and equipment, but also encourages employees to deal with hazards consciously and safely and optimises internal processes.

In addition to a targeted lockout/tagout configuration, the choice of suitable locking systems and devices determines the level of safety for your employees. ABUS offers an extensive range of suitable padlocks and locking devices which meet lockout/tagout requirements, giving you and your employees the good feeling of security.

The new highlights of our lockout/tagout range:

- **THE NEW 76 SERIES SAFETY LOCK**
The new dimension with over 150,000 guaranteed key variations
- **THE ABUS LOCKPOINT**
The flexible and adaptable storage solution to provide lockout locks for your employees
- **E245**
The first lockout device for motor circuit breakers in the world
- **THE NEW V500 UNIVERSAL VALVE LOCKOUT DEVICE**
for every type and size of ball valve handle
- **B810 PERMIT REDBOX™**
combines permit to work with storing your machinery locks
- **THE NEW T100/150 LOTO TAGS BY ABUS**
delivered in a resealable dispenser box

Click here for the
ABUS LoTo movie:





11-316

35

DANGER

**LOCKED
OUT**

DO NOT REMOVE

ABUS



THE SAFETY LOCKS 76 SERIES 74 SERIES 72 SERIES

The safety locks are the versatile cornerstones of lockout/tagout processes. They make for clear and direct communication, as they immediately signal that: "This area of the machine is blocked off from unauthorised access." In this way, you can prevent injuries and fatal accidents.

PS88
35421 2

We recommend our ABUS maintenance spray PS88 for the maintenance of your locking cylinder





TECHNOLOGY & DETAILS

- Solid aluminium body: lightweight yet stable and durable
- Plastic casing in 10 different colours ●●●●●●●●●●
- Automatic locking for user convenience and key retention function for greater safety
- Large variety of shackles: Steel, steel with plastic casing, stainless steel, plastic or flexible cable
- Precision cylinder with 8 pins
- Extremely resilient, coated brass key

THE ADDED VALUE FOR YOU

It's not just the high number of guaranteed key variations that speak for the new 76 series: the V-shaped incisions in the key provide absolute precision, thus increasing security during the locking process.



76 SERIES SAFETY LOCKS THE INNOVATION OF SAFETY LOCKS

The 76 series characterises a new dimension when it comes to lockout/tagout. With the world innovation, the 8-pin cylinder, over 200,000 guaranteed key variations are possible. In order to meet your requirements for a wide range of applications, the lock is available with 9 different shackle variants.

This way, no wish is left unfulfilled. Locking authorisations at various levels are also just as easy to achieve as mapping complex structures. Aspects where conventional master key systems leave something to be desired are where the new 76 series really takes off.



76BS/40

- Steel shackle
- Diameter: 4.76 mm
- Shackle height 38 mm and 75 mm

The **all-rounder** for a variety of applications.



76/40

- Shackle made of steel with plastic casing
- Diameter: 6.5 mm
- Shackle height 38 mm and 75 mm

Use with sensitive or delicate equipment. The **plastic casing protects against scratches** and also acts as **electrical insulation**.



76IB/40

- Stainless-steel shackle
- Diameter: 4.76 mm
- Shackle height 38 mm and 75 mm

Use in situations in which a **weather-resistant lock** is required, or when the ambient conditions call for a **stainless-steel shackle** due to the liquids or substances used.



76PS/40

- Plastic shackle
- Diameter: 4.92 mm
- Shackle height 38 mm

With this shackle, the lock becomes an "electrician's lock". Thanks to its non-conductive properties, it provides adequate **protection against electric flashovers**. In addition, it is the lightest lock in the series thanks to the weightless shackle.

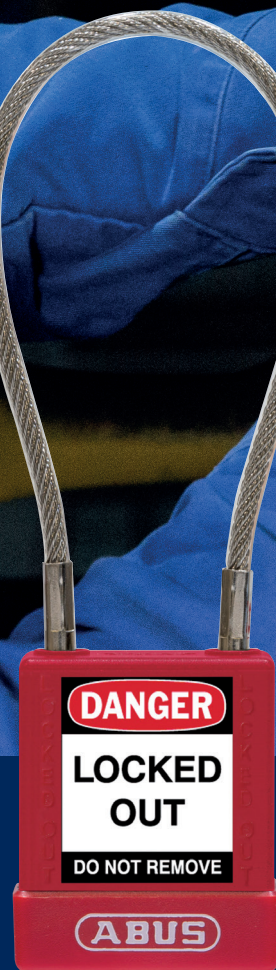

76/40CAB

- Stainless-steel cable with plastic casing
- Diameter: 4.76 mm
- Cable length 20 or 40 cm

Not a rigid shackle. **With a flexible cable**, this lock is suitable for **locking out several points at the same time** or when the locking points are difficult to access. The cables are available **in a choice of 20 cm or 40 cm lengths**.



Over 200,000
guaranteed
key differs

Item	Item description	EAN 4003318	PL dimensions in mm			Locking elements	Weight in kg			
			Lock body thickness	Total height	Shackle thick- ness					
76BS/40	76BS/40 ● red	84781 3	40	90	22	20	39	4.76	8	0.125
76BS/40	● yellow 84782 0	76BS/40	● orange 84785 1	76BS/40	● black 84788 2					
76BS/40	● green 84783 7	76BS/40	● purple 84786 8	76BS/40	● grey 84789 9					
76BS/40	● blue 84784 4	76BS/40	○ white 84787 5	76BS/40	● brown 84790 5					
76/40	76/40 ● red	84768 4	40	91	22	19	38	6.5	8	0.126
76/40	● yellow 84769 1	76/40	● orange 84772 1	76/40	● black 84775 2					
76/40	● green 84770 7	76/40	● purple 84773 8	76/40	● grey 84776 9					
76/40	● blue 84771 4	76/40	○ white 84774 5	76/40	● brown 84777 6					
76IB/40	76IB/40 ● red	84794 3	40	90	22	20	39	4.76	8	0.124
76IB/40	● yellow 84795 0	76IB/40	● orange 84798 1	76IB/40	● black 84801 8					
76IB/40	● green 84796 7	76IB/40	● purple 84799 8	76IB/40	● grey 84802 5					
76IB/40	● blue 84797 4	76IB/40	○ white 84800 1	76IB/40	● brown 84803 2					
76PS/40	76PS/40 ● red	84807 0	40	90	22	20	39	4.92	8	0.108
76PS/40	● yellow 84808 7	76PS/40	● orange 84811 7	76PS/40	● black 84814 8					
76PS/40	● green 84809 4	76PS/40	● purple 84812 4	76PS/40	● grey 84815 5					
76PS/40	● blue 84810 0	76PS/40	○ white 84813 1	76PS/40	● brown 84816 2					
76/40HB75	76/40HB75 ● red	84820 9	40	128	22	19	75	6.5	8	0.136
76/40HB75	● yellow 84822 3	76/40HB75	● orange 84829 2	76/40HB75	● black 84832 2					
76/40HB75	● green 84826 1	76/40HB75	● purple 84830 8	76/40HB75	● grey 84833 9					
76/40HB75	● blue 84828 5	76/40HB75	○ white 84831 5	76/40HB75	● brown 84834 6					
76BS/40HB75	76BS/40HB75 ● red	84838 4	40	127	22	20	76	4.76	8	0.134
76BS/40HB75	● yellow 84839 1	76BS/40HB75	● orange 84842 1	76BS/40HB75	● black 84845 2					
76BS/40HB75	● green 84840 7	76BS/40HB75	● purple 84843 8	76BS/40HB75	● grey 84846 9					
76BS/40HB75	● blue 84841 4	76BS/40HB75	○ white 84844 5	76BS/40HB75	● brown 84847 6					
76IB/40HB75	76IB/40HB75 ● red	84851 3	40	127	22	20	76	4.76	8	0.132
76IB/40HB75	● yellow 84852 0	76IB/40HB75	● orange 84855 1	76IB/40HB75	● black 84858 2					
76IB/40HB75	● green 84853 7	76IB/40HB75	● purple 84856 8	76IB/40HB75	● grey 84859 9					
76IB/40HB75	● blue 84854 4	76IB/40HB75	○ white 84857 5	76IB/40HB75	● brown 84860 5					
76/40CAB20	76/40CAB20 ● red	84864 3	40	flexible	22	flexible	flexible up to 90	4.76	8	0.117
76/40CAB20	● yellow 84865 0	76/40CAB20	● orange 84868 1	76/40CAB20	● black 84871 1					
76/40CAB20	● green 84866 7	76/40CAB20	● purple 84869 8	76/40CAB20	● grey 84872 8					
76/40CAB20	● blue 84867 4	76/40CAB20	○ white 84870 4	76/40CAB20	● brown 84873 5					
76/40CAB40	76/40CAB40 ● red	84877 3	40	flexible	22	flexible	flexible up to 190	4.76	8	0.122
76/40CAB40	● yellow 84878 0	76/40CAB40	● orange 84881 0	76/40CAB40	● black 84884 1					
76/40CAB40	● green 84879 7	76/40CAB40	● purple 84882 7	76/40CAB40	● grey 84885 8					
76/40CAB40	● blue 84880 3	76/40CAB40	○ white 84883 4	76/40CAB40	● brown 84886 5					
VARIANTS:										
	LockReg	LockReg: Closure numbers are noted and saved								
	GL	LockReg expanded: Closure numbers are noted and saved, incl. code marking on the lock								
	GL	76/40 keyed alike								
	GL according to design	76/40 keyed alike according to specification								
	MK / GMK	76/40 master key system codified								
		76/40 general master key system codified								
	SupportBox	Delivery in SupportBox (see page 44)								



Item	Item description	EAN 4003318	PL dimensions in mm					Locking elements	Weight in kg	
			Lock body thickness	Total height	Lock thick- ness	Clear shackle width	Clear shackle height			Shackle thick- ness
74/40	74/40 ● red	59108 2	40	90	20	19	38	6.5	6	0.1
74/40	● yellow 59110 5	74/40	● orange 59113 6		74/40	● black 59111 2				
74/40	● green 59112 9	74/40	● purple 59115 0		74/40	● grey 58979 9				
74/40	● blue 59109 9	74/40	○ white 58978 2		74/40	● brown 59114 3				
74BS/40	74BS/40 ● red	77569 7	40	89	20	20	39	4.76	6	0.099
74BS/40	● yellow 77567 3	74BS/40	● orange 77572 7		74BS/40	● black 77575 8				
74BS/40	● green 77570 3	74BS/40	● purple 77573 4		74BS/40	● grey 77576 5				
74BS/40	● blue 77571 0	74BS/40	○ white 77574 1		74BS/40	● brown 77577 2				
74/40HB/75	74/40HB/75 ● red	59116 7	40	126	20	19	75	6.5	6	0.11
74/40HB75	● yellow 58031 4	76/40HB75	● orange 58985 0		74/40HB75	● black 58980 5				
74/40HB75	● green 58984 3	74/40HB75	● purple 58986 7		74/40HB75	● grey 58988 1				
74/40HB75	● blue 59117 4	74/40HB75	○ white 58987 4		74/40HB75	● brown 58032 1				
74BS/40HB/75	74BS/40HB/75 ● red	79584 8	40	125	20	20	76	4.76	6	0.108
74BS/40HB75	● yellow 85581 8	74BS/40HB75	● orange 85583 2		74BS/40HB75	● black 85586 3				
74BS/40HB75	● green 85582 5	74BS/40HB75	● purple 58986 7		74BS/40HB75	● grey 85598 6				
74BS/40HB75	● blue 82561 3	74BS/40HB75	○ white 85585 6		74BS/40HB75	● brown 85599 3				
74LB/40	74LB/40 ● red	34970 6	40	120	20	19	38	6.5	6	0.109
74LB/40	● yellow 50335 1	74LB/40	● orange 50332 0		74LB/40	● black 50299 6				
74LB/40	● green 50306 1	74LB/40	● purple 50333 7		74LB/40	● grey 50309 2				
74LB/40	● blue 50300 9	74LB/40	○ white 50334 4		74LB/40	● brown 50305 4				
VARIANTS:										
	LockReg	LockReg: Closure numbers are noted and saved								
		LockReg expanded: Closure numbers are noted and saved, incl. code marking on the lock								
	GL	74/40 keyed alike								
	GL according to design	74/40 keyed alike according to specification								
	MK / GMK	74/40 master key system codified								
		74/40 general master key system codified								
	SupportBox	Delivery in SupportBox (see page 44)								

74 SERIES SAFETY LOCKS DUST PROOF

The 74 series is the long-established, tried-and-tested safety lock in our range. The 10 different colours provide you with ample scope to outline your organisation and prevent mix-ups. Thanks to the use of FDA-tested lubricant and the excellent detectability, the 74 series is also suitable for use in the food industry.



74/40 red



74/40 open

TECHNOLOGY & DETAILS

- Aluminium body: very lightweight yet sturdy
- Plastic casing in 10 different colours 
- Automatic locking for user convenience and key retention function for greater safety
- Precision cylinder with six pins
- Electrically insulated, extremely heat-resistant – use even in hot and electrical environments
- Thanks to FDA-approved lubricant and good detectability, it is suitable for the food industry

THE ADDED VALUE FOR YOU

Not a conventional plastic lock – thanks to the aluminium body, the 74 series is significantly more durable and long-lasting.

72/40 SAFETY LOCKS EXCELLENT ENGRAVING PROPERTIES

The 8 intense colours of the 72 series provide a high recognition factor. Since it can be combined with the 74 series within one master key system, it forms the optimal expansion to the safety lock series.



72/40

72/40HB75

72/1B40

TECHNOLOGY & DETAILS

- Lock body made from special aluminium – light weight but high security
- Available in eight different colours ●●●●●●●●
- Automatic locking without a key by pressing down on the shackle
- Resistant anodised layer instead of eloxal.

THE ADDED VALUE FOR YOU

Locks from the 72/40 series are an alternative to the plastic-covered safety locks. Anodised bodies for excellent corrosion protection and brilliant colours, great engraving properties and large engraving surfaces offer an abundance of design freedom for the various applications in your business.



Item	Item description	EAN 4003318	Padlock dimensions in mm						Locking elements	Weight in kg
			Width of lock body	Total height	Depth of lock body	Horizontal shackle clearance	Vertical shackle clearance	Shackle diameter		
72/40	72/40 ● red	43602 4	38.5	73	19	20	26	6.5	6	0.114
72/40	● yellow 43603 1	72/40	● orange	43601 7	72/40	● brown	01832 9	6.5	6	0.114
72/40	● green 43600 0	72/40	● purple	43598 0						
72/40	● blue 43599 7	72/40	● black	43959 9						
72/40HB40	72/40HB40 ● red	43608 6	38.5	86	19	20	40	6.5	6	0.12
72/40HB40	● yellow 43609 3	72/40HB40	● orange	43607 9	72/40HB40	● brown	01836 7	6.5	6	0.12
72/40HB40	● green 43606 2	72/40HB40	● purple	43604 8						
72/40HB40	● blue 43605 5	72/40HB40	● black	43960 5						
72/40HB75	72/40HB75 ● red	18691 2	38.5	121	19	20	75	6.5	6	0.139
72/40HB75	● yellow 18692 9	72/40HB75	● orange	74190 6	72/40HB75	● brown	85600 6	6.5	6	0.139
72/40HB75	● green 70556 4	72/40HB75	● purple	81147 0						
72/40HB75	● blue 70555 7	72/40HB75	● black	70554 0						
Aluminium shackle	72AS/40 colour, all colours	on request	38.5	73	19	20	26	6.5	6	0.097
	72AS/40HB40 colour, all colours	on request	38.5	86	19	20	40	6.5	6	0.099
Stainless- steel shackle	72IB/40 colour, all colours	on request	38.5	73	19	20	26	6.5	6	0.115
	72IB/40HB40 colour, all colours	on request	38.5	86	19	20	40	6.5	6	0.121
	72IB/40HB75 colour, all colours	on request	38.5	121	19	20	75	6.5	6	0.138
Versions										
	LockReg	LockReg: Key codes are noted and saved.								
		LockReg enlarged: Key codes are noted and saved, lock body is engraved with key code.								
	KA	72/40 keyed alike								
	KA according to sample	72/40 keyed alike according to specification								
	Keying Systems	72/40 master key system with coined key codes at the key head								
		72/40 grand master key system with coined key codes at the key head								
	Support box	Shipment in support-box (min. 90 locks)								

72/30 SAFETY LOCKS SIMPLE, COMPACT ADDITION

For situations in which the selected safety locks are too large, 72/30 locks are the ideal addition. With a body width of only 32 mm and a shackle diameter of 4.76 mm, they also fit in cabinets or small eyelets.



72/30



72/30HB50



72/30CAB

TECHNOLOGY & DETAILS

- Very lightweight and yet robust thanks to its aluminium body
- 8 different colours 
- With key retention for increased safety
- Resistant eloxal layer provides good corrosion protection
- Resistant anodised layer provides good corrosion resistance.

THE ADDED VALUE FOR YOU

The locks of the 72 series are extremely robust yet still light thanks to their aluminium body. With the various shackle variants, they are thus the perfect addition to the rest of the safety locks, as they fit easily into every environment.

Item	Item description	EAN 4003318	PL dimensions in mm					Locking elements	Weight in kg	
			Lock body thickness	Total height	Lock thickness	Clear shackle width	Clear shackle height			Shackle thickness
72/30	72/30 ● red	82209 4	32	65	16	17	26.5	4.76	5	0.066
72/30	● yellow 82210 0	72/30	● orange	82220 9	72/30	● brown	82223 0			
72/30	● green 82218 6	72/30	● purple	82221 6						
72/30	● blue 82219 3	72/30	● black	82222 3						
72/30HB50	72/30HB50 ● red	87445 1	32	89	16	17	51	4.76	5	0.069
72/30HB50	● yellow 87447 5	72/30HB50	● orange	87449 9	72/30HB50	● brown	87452 9			
72/30HB50	● green 87448 2	72/30HB50	● purple	87450 5						
72/30HB50	● blue 87446 8	72/30HB50	● black	87451 2						
72AS/30HB38	72AS/30HB38 ● red	87453 6	32	78	16	17	39	4.76	5	0.055
72AS/30HB38	● yellow 87455 0	72AS/30HB38	● orange	87457 4	72AS/30HB38	● brown	87460 4			
72AS/30HB38	● green 87456 7	72AS/30HB38	● purple	87458 1						
72AS/30HB38	● blue 87454 3	72AS/30HB38	● black	87459 8						
72IB/30	72IB/30 ● red	87461 1	32	65	16	17	26.5	4.76	5	0.066
72IB/30	● yellow 87463 5	72IB/30	● orange	87465 9	72IB/30	● brown	87468 0			
72IB/30	● green 87464 2	72IB/30	● purple	87466 6						
72IB/30	● blue 87462 8	72IB/30	● black	87467 3						
72IB/30HB50	72IB/30HB50 ● red	87469 7	32	89	16	17	51	4.76	5	0.069
72IB/30HB50	● yellow 87471 0	72IB/30HB50	● orange	87473 4	72IB/30HB50	● brown	87476 5			
72IB/30HB50	● green 87472 7	72IB/30HB50	● purple	87474 1						
72IB/30HB50	● blue 87470 3	72IB/30HB50	● black	87475 8						
72/30CAB20 Cable length 20 cm	72/30CAB20 ● red	87477 2	32	flexible	16	flexible	flexible up to 100	4.76	5	0.078
72/30CAB20	● yellow 87483 3	72/30CAB20	● orange	87480 2	72/30CAB20	● brown	87484 0			
72/30CAB20	● green 87479 6	72/30CAB20	● purple	87481 9						
72/30CAB20	● blue 87478 9	72/30CAB20	● black	87482 6						
72/30CAB40 Cable length 40 cm	72/30CAB40 ● red	87485 7	32	flexible	16	flexible	flexible up to 180	4.76	5	0.082
72/30CAB40	● yellow 87487 1	72/30CAB40	● orange	87489 5	72/30CAB40	● brown	87492 5			
72/30CAB40	● green 87488 8	72/30CAB40	● purple	87490 1						
72/30CAB40	● blue 87486 4	72/30CAB40	● black	87491 8						
Options:										
	LockReg	LockReg: Closure numbers are noted and saved.								
		LockReg expanded: Closure numbers are noted and saved, incl. code marking on the lock								
	GL	72/30 keyed alike								
	GL according to design	72/30 keyed alike according to specification								
	MK / GMK	72/30 master key system codified								
		72/30 general master key system codified								
	SupportBox	Delivery in SupportBox (see page 44)								

FOR THE PERFECT ORGANISATION SUPPORT – MASTER KEY SYSTEMS

MASTER KEY SYSTEMS

Why a MK system?

Such a system is required if a master key that can open all installed locks is desired, e.g. for carrying out a safe emergency opening.

In a master key system, keyed-different (KD) and keyed-alike (KA) sets as well as combinations of the two can be combined.

Why do we need this?

Carefully planned organisation of locks could save lives.

For example:

Personal identification locks (PIS) are ALWAYS keyed different (KD). So every employee has their own lock with their own key. This key will not fit into another employee's lock and vice versa. Machine identification locks (MIS) which are used to secure the machine against power reactivation can either be keyed different (KD) or keyed alike (KA) depending on your plans.

The use of a control key must be clearly regulated. It is locked away in a secure location (e.g. in a safe) and is only used if locks need to be opened in unforeseeable circumstances and the relevant employees are not present.

Allow our experts to advise you and find the perfect solution.

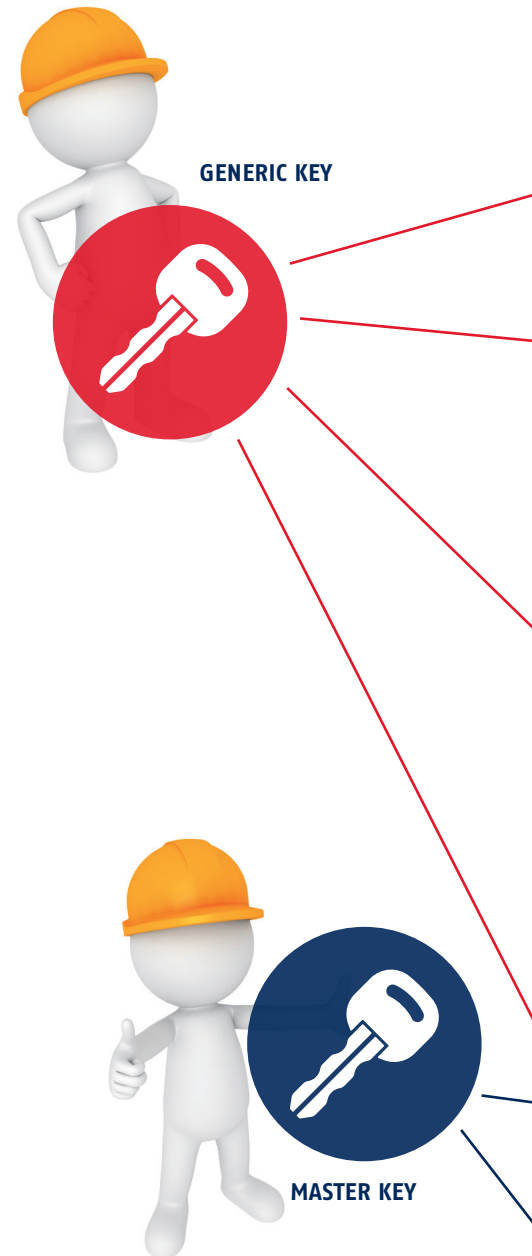

MACHINE IDENTIFICATION LOCKS

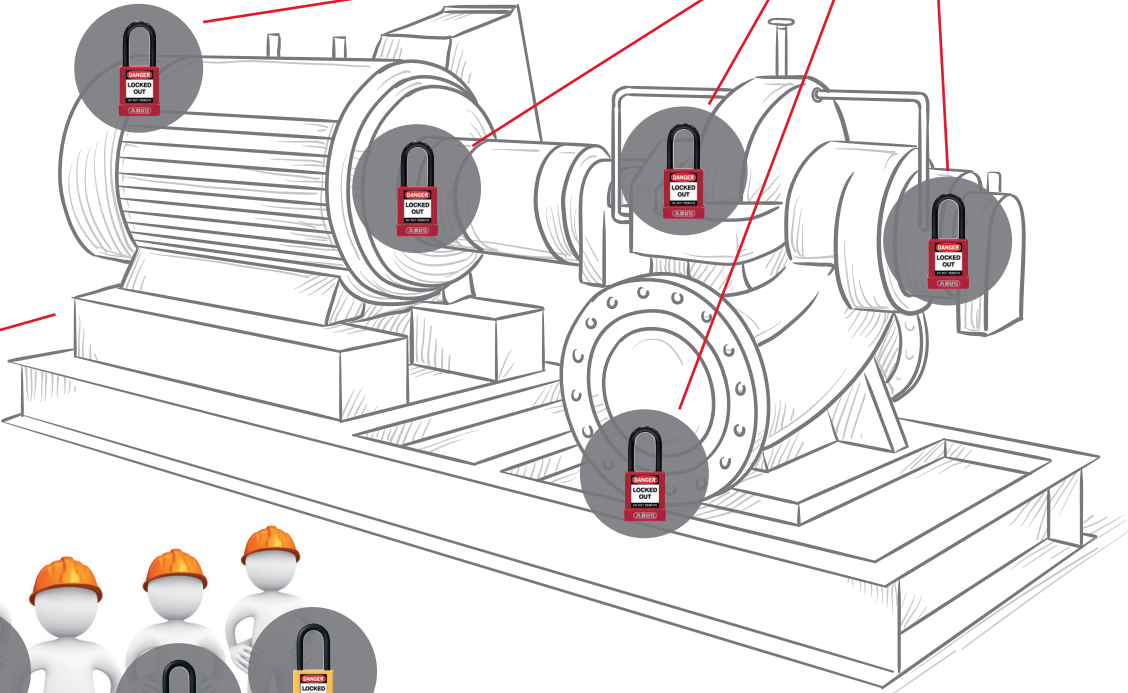

PERSONAL IDENTIFICATION LOCKS

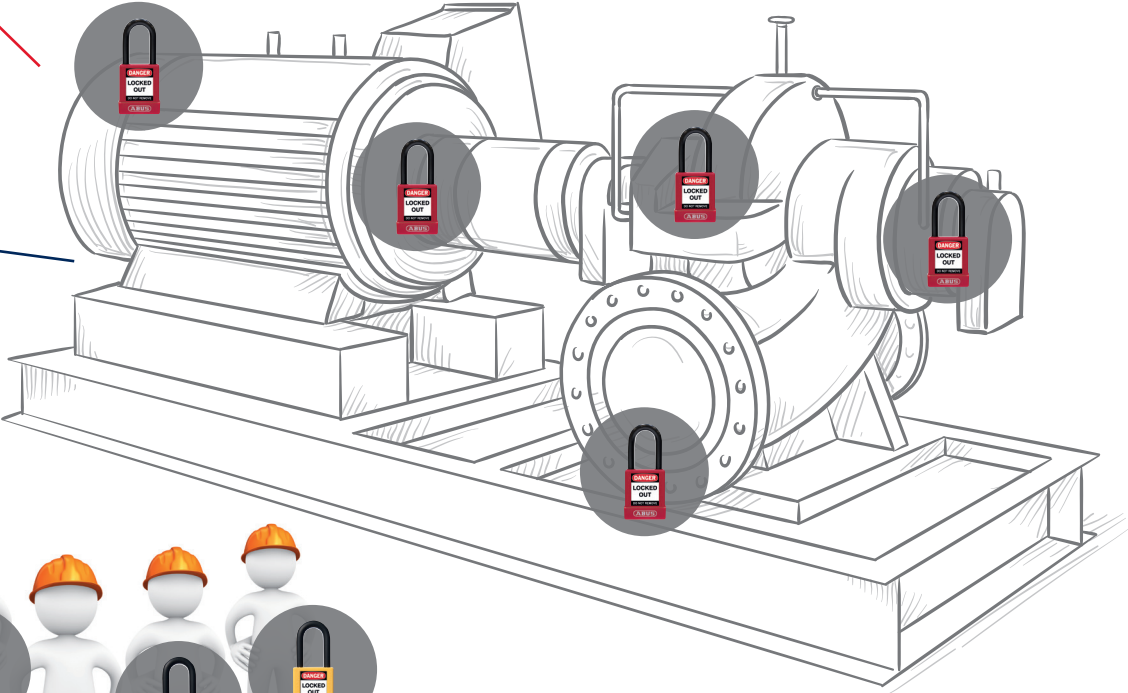



E201

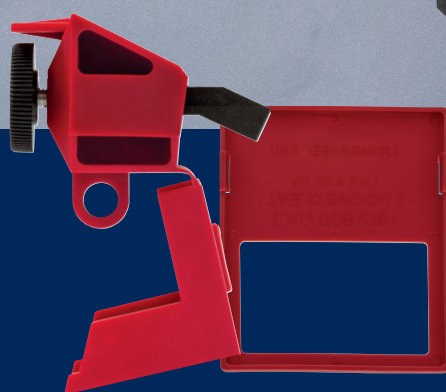

E211

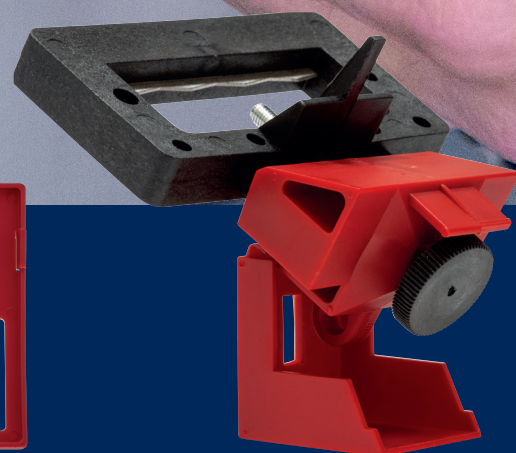

E212 open

TECHNOLOGY & DETAILS

- High-quality materials: durable, robust, non-conductive
- Easy to use with screw mechanism for safe (tool-free) mounting
- For padlocks with shackle diameters of up to 7 mm

THE ADDED VALUE FOR YOU

You can secure the E203 with a cable lock or a cable lockout. This allows you to lock several circuit breakers in a row.

THE LOCKOUTS FOR CIRCUIT BREAKERS

The small and handy circuit breaker lockouts are suitable for all standard and miniature circuit breakers. With the new E203 lockout, you can secure your circuit breakers vertically and horizontally via the multifunction eyelet. This enables you to lock several circuit breakers in a row using several lockouts and a cable lock.

In order to be able to lock out circuit breakers and disconnectors for 480 / 600V or even larger breakers, there are the new E211 and E212. They are applied in the same way as we are used to from E201. Thanks to the hand wheel for fixing on the circuit breaker, no additional tool is needed. Fast, safe and simple.

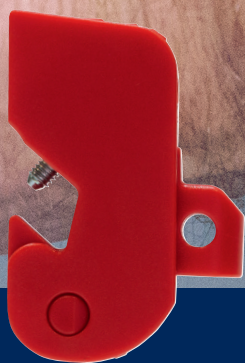

E203 closed

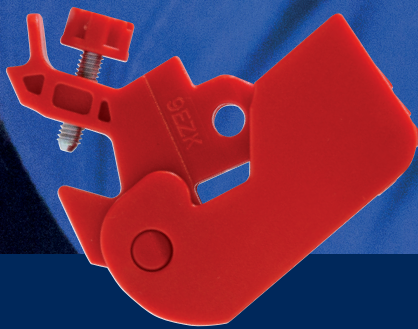

E203 opened

Item	Item description	EAN 4003318	Outer dimensions						Colour
			No. of padlock insert holes	Padlock insert holes in mm	Length mm	Width mm	Depth mm	Max thickness of connection rod:	
E203	Universal circuit breaker lockout device E203 for single-pole and multi-pole circuit breakers	77795 0	1*	5 or 7	53	35	17		red
E201	Circuit breaker lockout device for single-pole circuit breakers	00368 4	1	7	70	26	32	18 mm	red
E211	Circuit breaker lockout device for 480 V / 600 V breakers	64295 1	1	7	66	56	42	4.2 mm	red
E212	Circuit breaker lockout device for oversized breakers	64297 5	1	7	92	96	68	7.2	rot

*dependent on the shackle diameter



TECHNOLOGY & DETAILS

- The E245 is placed on the motor circuit breaker, clamped using the locking mechanism, and secured using a padlock
- For all motor circuit breakers with a height or switch front of 45 mm

THE ADDED VALUE FOR YOU

With the ABUS E245, you will achieve a significantly higher level of security when it comes to electrical isolation. Motor circuit breakers cannot simply be switched off any more simply be switched ON any more

With the ABUS E245, unsolvable becomes simply ingenious.



NEW IN THE LOTO WORLD. SIMPLY. INGENUOUS.

The first universal lockout device for motor circuit breakers.



E245

Item	Item description	EAN 4003318	Outer dimensions			Colour
			Length mm	Width mm	Depth mm	
E245	E245 motor circuit breaker lockout	89481 7	57	43	43	red/black



TECHNOLOGY & DETAILS

- Easy to use: The lockout device is screwed into the screw base and prevents the fuse cartridge from being inserted
- Includes a holder for padlocks with shackle diameters up to 6.5 mm
- Padlock holder can be rotated as required
- Includes a handy special key which can be stored on the fitted shackle if necessary

THE ADDED VALUE FOR YOU

- 2-in-1: Thanks to the stepped thread diameters, each locking device covers two standard screw threads:
- E218 for E14 and E18 threads (for D01 + D02 screw fuses, NEOZED System)
 - E233 for E27 and E33 threads (for DII + DIII screw fuses, DIAZED System).

THE LOCKOUTS FOR FUSES

E218 and E233 are the perfect choice for securing fuses. Several screw bases can be secured in series with the flexible holder using a cable lock. To ensure clear communication, the lockouts are equipped with a corresponding warning sign.



E233

E218

Item	Item description	EAN 4003318	Outer dimensions			Colour		
			Number of hanging points	Hanging points in mm	Length in mm		Width in mm	Depth in mm
E218	D0 fuse lockout for screw fuses D01+D02 (NEOZED system)	83677 0	1	7	52	25	25	red/ yellow
E233	D fuse lockout for screw fuses DII+DIII (DIAZED system)	83680 0	1	7	61	40	40	red/ yellow

THE LOCKS FOR VALVES

The ABUS valve lockouts cover the wide range of different valves. We can offer you the right solution for every valve.



TECHNOLOGY & DETAILS

Gate valve lockouts

- High-quality ABS: long-lasting, robust, non-conductive
- Five sizes: Handwheels of 1 to 13 inch valves
- Padlocks can be comfortably inserted thanks to the 9 mm hole diameter
- Release center piece for handwheels with spindle
- Self-adhesive warning labels in various languages

Ball valves

- Different versions depending on application scenario and operating steps

The universal solution which fits on every valve handle

- V500 – for virtually all handle sizes and shapes
- Creates a mounting point on the handle which is secured against a counterpoint using a cable lockout
- Wide adjustment range
- Large, specially shaped contact surfaces (rubberised on one side) for the ideal valve handle grip
- Ergonomically shaped rotary handle for quick adjustment
- Intuitive and user-friendly



THE ADDED VALUE FOR YOU

Products to secure a very wide range of valves enable quick and practical protection.



V303



V423



V442



V500



V500 set

Item	Item description	EAN 4003318	Outer dimensions					Other dimensions		Colour
			Number of hang- ing points	Hanging points in mm	Length in mm	Width in mm	Depth in mm	Inner height in mm	Inner Ø in mm	
V303	Gate valve lockout for straight way valves 1" to 2.5"	00362 2	1	9	120	78	35	28	70	red
V305	Gate valve lockout for straight way valves 2.5" to 5"	00364 6	1	9	184	143	49	35	131	red
V307	Gate valve lockout for straight way valves 5" to 6.5"	00365 3	1	9	228	184	54	39	172	red
V310	Gate valve lockout for straight way valves 6.5" to 10"	00366 0	1	9	322	272	73	61	268	red
V313	Gate valve lockout for straight way valves 10" to 13"	00367 7	1	9	416	368	73	55	358	red
V423	Small ball valve lockout 0.25" to 1", made of metal	00299 1	1	7	90	52	63			red
V426	Large ball valve lockout 1.25" to 3", made of metal	00300 4	1	7	148	125	122			red
V442	Small ball valve lockout, made of plastic	00452 0	1	7	136	109	78			red
V448	Large ball valve lockout, made of plastic	00453 7	1	8	307	220	113			red
V500	Universal ball valve lockout device	87151 1	1	7	75	72	36			red
V500 set	Universal ball valve lockout set with the C506 Safelex™ cable lockout device	87152 8	6	9						red/ black

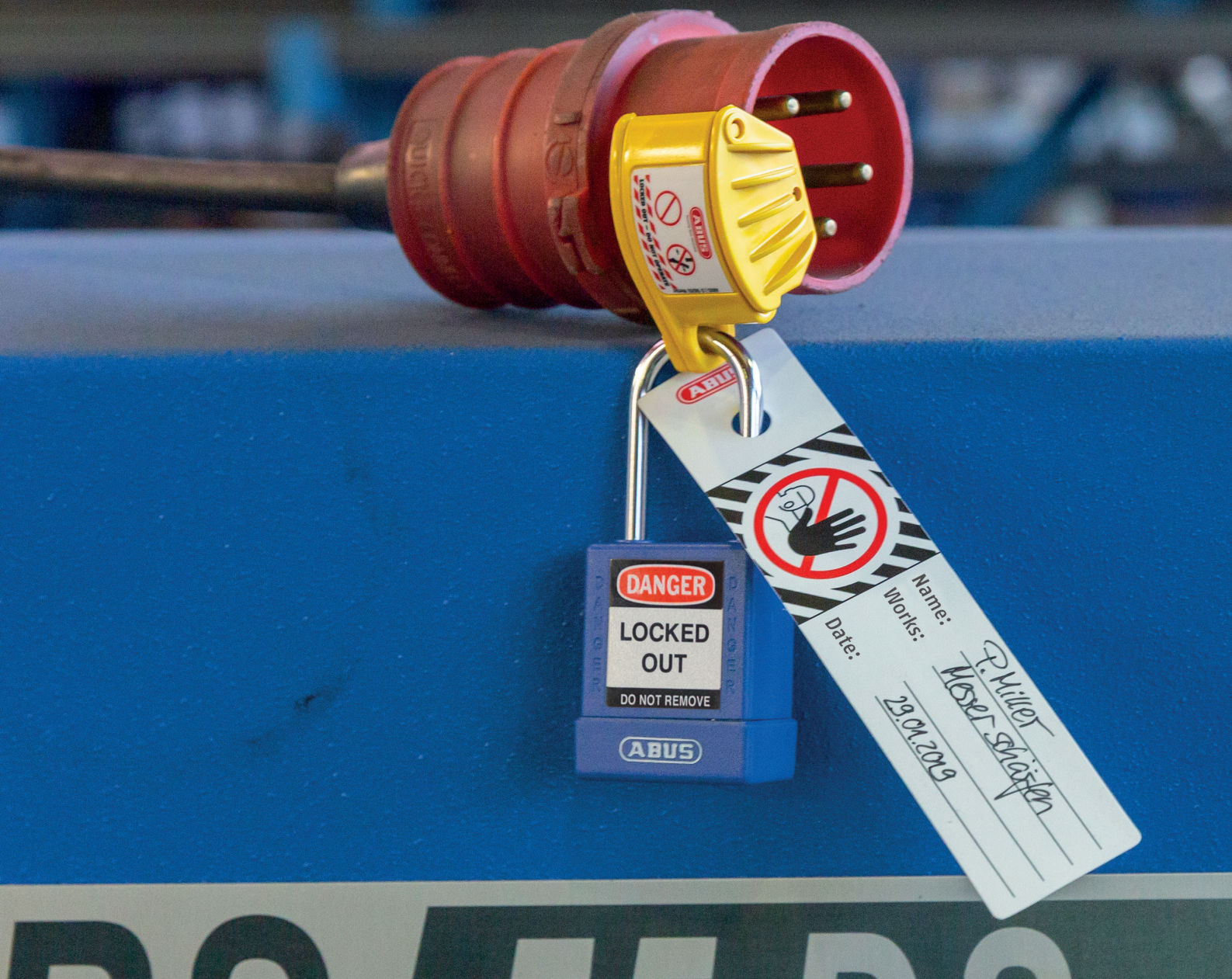

TECHNOLOGY & DETAILS

Plug locks

- Two sizes: for standard plug 110/220 V up to industrial plugs 550 V (a comparison of the plug and locking dimensions is recommended before ordering)
- Cable feed at both ends to secure plug connections
- For up to four padlocks with shackle diameters of up to 9 mm
- Pneumatic lockout P604, – Universally usable for all types of compressed air couplings

Gas cylinder lockout

- High-quality polypropylene: long-lasting, robust, non-conductive
- For a padlock with a shackle diameter of up to 9 mm

NEW

Control panel lockouts

- Lockouts to prevent the use of large plugs and control panels
- Available in two sizes
- Made of lightweight material (polyester)
- Closable thanks to the strap
- For padlocks with diameters of up to 7 mm

P600 plug lockout

- To lock out industrial plugs from 16A (3-pole) to 125A (5-pole)
- For a padlock
- Light, handy and space-saving

LOCKOUT DEVICES FOR CONNECTIONS

The ABUS product range is also expanding in the field of plug lockouts: the new P600 plug lockout for industrial plugs is space-saving, intuitive, and suitable for all standard plug sizes.

The new P604 pneumatic lockout device is a real all-rounder. Simple and intuitive to use, P604 encloses compressed air couplings of different shapes and sizes and is then secured with one or two padlocks. This prevents accidental or unauthorized coupling.



P600



P616

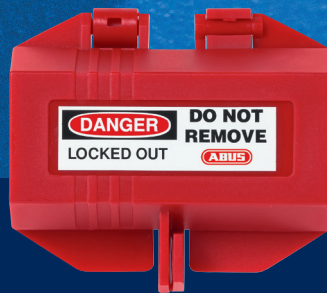

P110



P604



P606

Item	Item description	EAN 4003318	Outer dimensions			Other dimensions		Colour		
			Number of hanging points	Hanging points in mm	Length in mm	Width in mm	Depth in mm		Inner height in mm	Inner ø in mm
P110	Small plug lockout, up to 110 V	00450 6	2	9	88	80	50	43	12	red
P550	Large plug lockout	00451 3	4	9	177	118	83	74	25	red
P600	Universal industrial plug lockout 16-32 A (3-pole) and 60-125 A (5-pole)	85033 2	1	7	55	39	27			yellow
P604	Pneumatic lockout device	64296 8	2	8	196	34	5,4			
P606	Gas cylinder lockout	00449 0	1	9	164	127	95	152	80	yellow
P616	Small control panel lockout	86524 4	1	7	450	160	160			red
P625	Large control panel lockout	86525 1	1	7	450	250	250			red

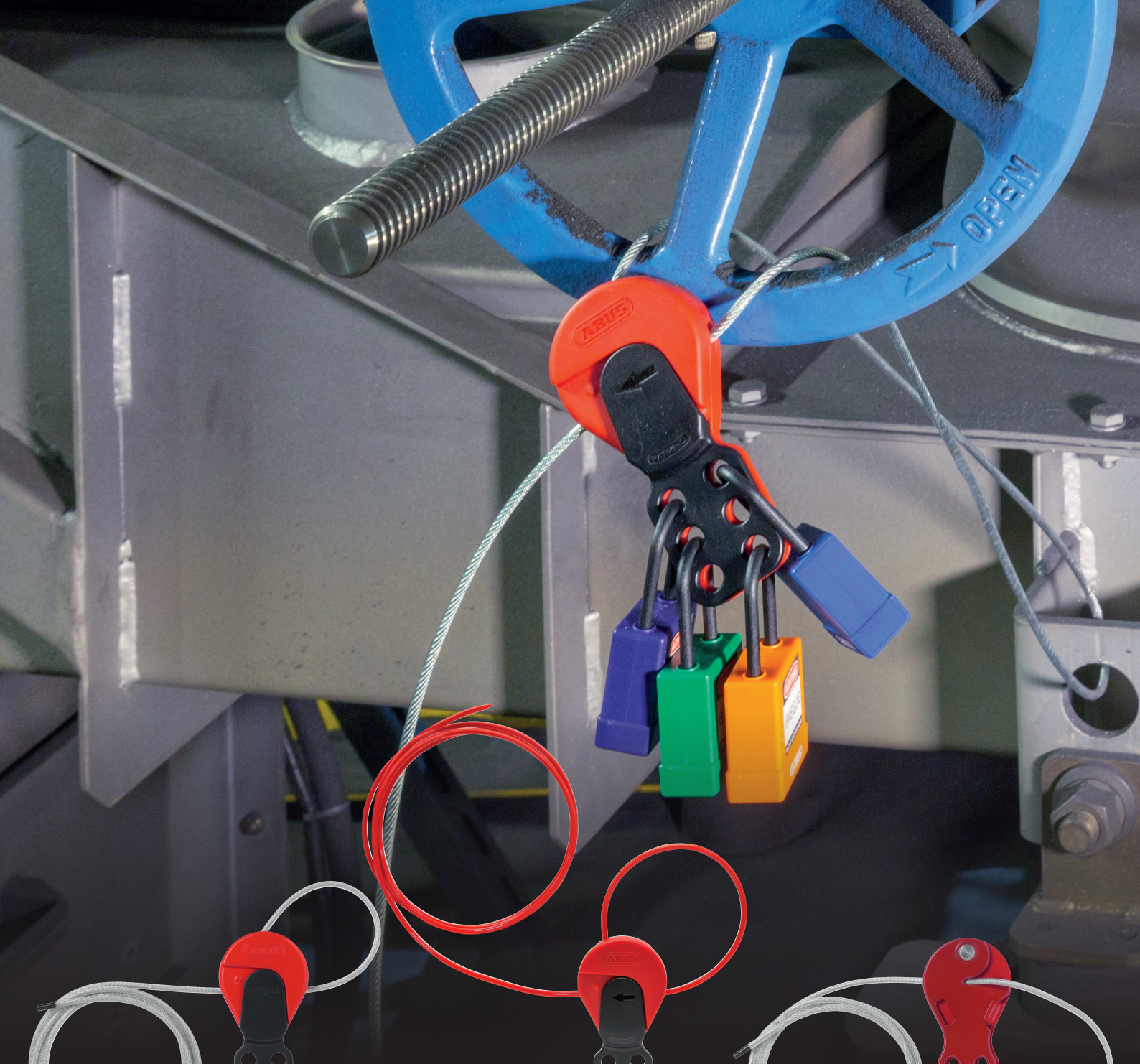

C503



C523



C553

TECHNOLOGY & DETAILS

Safelex™ universal cable lockout

- Simple, intuitive design
- Patented clamping mechanism for securely fixing the cable
- Retightening possible at any time, even when locked
- Either insulated metal cable or plastic cable – available in various lengths and interchangeable if necessary
- The nylon version is particularly suitable in the electrical sector
- For up to six padlocks

Standard cable lockouts

- Simple, intuitive design
- Insulated, replaceable metal cables in various lengths
- You can easily shorten the nylon cable on your own
- For up to six padlocks

THE ADDED VALUE FOR YOU

Is there no suitable locking solution at the moment? Sure there is – with the universal lockouts, you can secure everything for which there are special solutions.

THE UNIVERSAL SOLUTION – CABLE LOCKOUTS

With the cable lockouts, you can lock a very wide range of energy sources. From handwheels to ball valves. These lockouts are suitable for virtually all mechanical locking processes.

Item	Item description	EAN 4003318	Outer dimensions			Other dimensions		Colour		
			Number of hanging points	Hanging points in mm	Length in mm	Width in mm	Depth in mm		Cable length in cm	Cable Ø in mm
C503	Safelex™ universal cable lockout with 1 m coated steel cable	00347 9	6	9	128	61	26	100	4.1	red/black
C506	Safelex™ universal cable lockout with 2 m coated steel cable	00348 6	6	9	128	61	26	200	4.1	red/black
C509	Safelex™ universal cable lockout with 3 m coated steel cable	00349 3	6	9	128	61	26	300	4.1	red/black
C515	Safelex™ universal cable lockout with 5 m coated steel cable	00353 0	6	9	128	61	26	500	4.1	red/black
C523	Safelex™ universal cable lockout with 1 m non-conductive nylon cable	77842 1	6	9	128	61	26	100	4.6	red/black
C526	Safelex™ universal cable lockout with 2 m non-conductive nylon cable	77843 8	6	9	128	61	26	200	4.6	red/black
C553	Standard cable lockout with 1 m coated steel cable	00355 4	6	7	128	61	16	100	4.1	red
C556	Standard cable lockout with 2 m coated steel cable	00356 1	6	7	128	61	16	200	4.1	red
C559	Standard cable lockout with 3 m coated steel cable	00359 2	6	7	128	61	16	300	4.1	red
C565	Standard cable lockout with 5 m coated steel cable	00361 5	6	7	128	61	16	500	4.1	red
REPLACEMENT CABLE:										
C503SC	1 m replacement cable for C503 Safelex™	85615 0						100	4.1	
C506SC	2 m replacement cable for C506 Safelex™	85616 7						200	4.1	
C509SC	3 m replacement cable for C509 Safelex™	85617 4						300	4.1	
C515SC	5 m replacement cable for C515 Safelex™	85618 1						500	4.1	
C523SC	1 m replacement nylon cable for C523 Safelex™	85619 8						100	4.6	red
C526SC	2 m replacement nylon cable for C526 Safelex™	85620 4						200	4.6	red



H701

H712

H751

H770

TECHNOLOGY & DETAILS

- For up to six padlocks
- High-quality materials for different fields of application
- Comes in two sizes in metal variant, optionally comes with engaging clamps for additional protection in steel variant

THE ADDED VALUE FOR YOU

Multiple locking is useful for applications where you need to hang more than one padlock. ABUS safety hasps work as multipliers and turn one mounting point into six.

SAFETY LOCKOUT HASPS

In order to always provide you with the right solution for your different applications, ABUS offers you the safety lockout hasps made of various materials in two sizes.



Item	Item description	EAN 4003318		Outer dimensions			Colour	
			Number of hanging points	Hanging points in mm	Length in mm	Width in mm		Depth in mm
H701	Small safety lockout hasps, 1", made of sheet steel	35766 4	6	9	115	45	10	red
H702	Large safety lockout hasps, 1.5", made of sheet steel	35768 8	6	9	128	60	10	red
H711	Small safety lockout hasps, 1", made of sheet steel with clips	33551 8	6	9	118	45	12	red
H712	Small safety lockout hasps, 1.5", made of sheet steel with clips	33552 5	6	9	131	60	12	red
H751	Small aluminium safety lockout hasps	00302 8	6	9	112	40	10	red
H752	Large aluminium safety lockout hasps	00340 0	6	9	124	50	10	red
H770	Safety lockout hasps made of plastic, non-conductive	00346 2	6	9	173	44	10	red

SAFETY REDBOX™ – FOR THE EFFICIENT ORGANISATION OF GROUP LOCKOUT

The SAFETY REDBOX™ is an outstanding aid when it comes to machine maintenance: within it, you can safely store all keys from the shutdown locks during the maintenance period. You can also use it to store machine locks when they are not in use. With the provided wall mount, you can create a defined point at each machine, and will thus have access to the right number of required machine locks.



GROUP LOCKOUT

The principle of group lockout processes is to separate conventional personal identification locks (PIS) from the additional machine identification locks (MIS). The PIS are for every single employee and show which person is undertaking maintenance or repair work when hung up. The MIS are used to prevent reactivation of the energy supplies to the machines and installations.

In a group lockout, the keys for the MIS are locked away inside the SAFETY REDBOX™. Each employee involved can then secure their personal lock on the SAFETY REDBOX™. In this way, the keys are safely locked away for later opening of the machine locks until the last employee has removed their personal lock. You can also immediately see which employee is working on the machine. Thanks to the wall mount, the SAFETY REDBOX™ provides even greater process safety.

TECHNOLOGY & DETAILS

- High level of stability in spite of low weight
- Ergonomic and space-saving fold-away handle
- Inside is exposed to light from all sides for better visibility of contents
- Innovative and secure locking mechanism for the lid
- Patented wall bracket for fixed point of reference and thus efficient and clearer organisation of group lockout

THE ADDED VALUE FOR YOU

The ergonomically designed carrier handle, the large fields of vision to monitor key presence and the particularly efficiently opening cover mark the SAFETY REDBOX™ as the ideal solution.



SAFETY REDBOX™



SAFETY REDBOX™ wall bracket

Item	Item description	EAN 4003318	Outer dimensions			Colour		
			Number of hanging points	Hanging points in mm	Length in mm		Width in mm	Depth in mm
B835	SAFETY REDBOX™ group lockout box	00298 4	12	7	240	174	94	red
B835WB	Replacement wall mount for B835 SAFETY REDBOX™	77771 4			174	40	20	red

B810 LOCKOUT AT ITS BEST

Work release notes in simple combination with pinpoint storage of machine and installation locks.

TECHNOLOGY & DETAILS

- 2 in 1: Incorporates permit-to-work procedures into standard group lockout – easiest way to combine both
- For up to 23 personal locks – locking both: equipment lock keys and A4 work permit form
- Handy design and size
- Thanks to enclosed wall-bracket suitable for stationary and mobile use
- Made of powder-coated steel sheet: robust and long-lasting

NEW

THE ADDED VALUE FOR YOU

Permit boxes help reduce time to complete group lockout procedures from start to finish. When placed near production equipment or somewhere in the facility where maintenance works is done regularly, permit boxes help minimise movement of equipment and personnel throughout the plant and give transparency to the involved workers. B810 Permit Redbox™ provides a place to keep equipment locks, secure the keys of placed locks and display corresponding work permits.

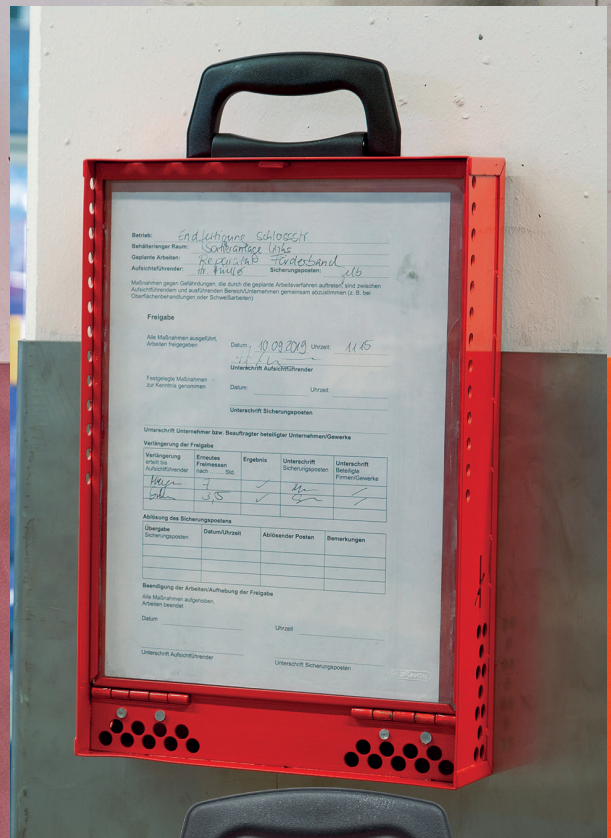

PERMIT REDBOX™ wall bracket

B810

Item	Item description	EAN	Contents	Weight	Dimensions	Wall mount dimensions	Colour
B810 Permit Redbox™	-	88882 3	1	3.8 kg	380 mm x 240 mm x 68 mm	174 mm x 40 mm x 10 mm	red



TECHNOLOGY & DETAILS

- Made of indestructible polypropylene synthetic paper
- With labelling fields on the back
- Available in two sizes and five languages
- Reclosable box with 9 mm punch hole for hooks
- In accordance with ASR A1.3 Labelling Directive, point 3.3. and point 5/5.1, section 6, 8, 9 DIN EN ISO 7010



THE ADDED VALUE FOR YOU

These tags are immediately visible and can be attached to every padlock. The tags are either permanent or erasable depending on the pen type used. This allows you to remove the text as needed and reuse the tags.



TAG OUT – THE IDENTIFICATION TAGS

Our strong, tear-resistant and writeable identification tags in two different sizes and five languages made of polypropylene. This improves safety during maintenance: You can write hints and warnings on the tags or label them with an employee's name or a department. Includes a resealable dispenser in which the identification tags are kept.



T150

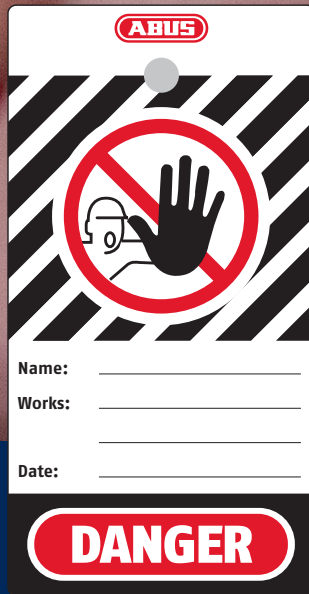

T100

Item	Item description	EAN 4003318	Contents	Dimensions TAGS		Dimensions DISPENSER Box			Colour
				Length in mm	Width in mm	Length in mm	Width in mm	Depth in mm	
T100 German	LOTO padlock small German in dispenser box	77806 3	100 tags	140	32	144	33	29	white
T100 French	LOTO padlock small French in dispenser box	77808 7	100 tags	140	32	144	33	29	white
T100 English	LOTO padlock small English in dispenser box	77807 0	100 tags	140	32	144	33	29	white
T100 Spanish	LOTO padlock small Spanish in dispenser box	78298 5	100 tags	140	32	144	33	29	white
T100 Swedish	LOTO padlock small Swedish in dispenser box	77809 4	100 tags	140	32	144	33	29	white
T150 German	LOTO padlock large German in dispenser box	77798 1	100 tags	146	76	149	78	29	white
T150 French	LOTO padlock large French in dispenser box	77802 5	100 tags	146	76	149	78	29	white
T150 English	LOTO padlock large English in dispenser box	77801 8	100 tags	146	76	149	78	29	white
T150 Spanish	LOTO padlock large Spanish in dispenser box	78299 2	100 tags	146	76	149	78	29	white
T150 Swedish	LOTO padlock large Swedish in dispenser box	77803 2	100 tags	146	76	149	78	29	white

LOTO KITS - INDIVIDUALLY ASSEMBLED

Compact and effective solutions are required for use in construction projects or for maintenance and repair of machinery and equipment used outside. ABUS developed the LoTo bags for particularly such purposes. These are suitable for occupational safety accessories such as safety locks, Safelex™ cable, tags and other locks.



TECHNOLOGY & DETAILS

- Bags available in two sizes
- Lightweight material (polyester)
- Thanks to the polyurethane coating, the bag is extremely flexible, water-repellent and resistant to heat and dirt
- 2-way zip
- Belt loop on the back

THE ADDED VALUE FOR YOU

The ideal solution to always have everything at hand. "This makes them suitable for storing LOTO locks and devices in your toolbox or vehicle. Thanks to their belt loop, they can also be carried on the man.



SL bag 130



SL bag 120

Item	Item description	EAN 4003318	Dimensions BAG			Contents	Colour
			Length in mm	Width in mm	Depth in mm		
SL bag 120	Small LoTo bag with zip	72656 9	180	120	45	empty	red
SL bag 130	Large LoTo bag with zip	77235 1	190	190	85	empty	red



LoTo kit example: "mechanically large"



LoTo kit example: "electrically large"

Or quite flexible...

Be it for mechanical or electrical lockout devices, be it with key-alike or key-different locks, no matter what lock colour or shackle variant you want – put together the LoTo kit that is right for you. So you always have exactly the lockout devices and locks you need for on the go. We will gladly advise you on how to build your personal kit.

An Händler:			
Kunden-Nr.:			
Bezeichnung			
LOTO Kits			
Elektrisch			
Tasche SL Bag 130, groß		Farbe:	
Tasche SL Bag 120, klein		Farbe:	
für den Inhalt:	Bügel:	Farbe:	
Schloss: 76/40	Bügel:		
Schloss: 74/40	Bügel:		
Schloss: 72/30	Bügel:		
Hauptschalterverriegelung H770			
Schutzschalter-Verriegelung E201, einpolig			
Schutzschalter-Verriegelung E202, mehrpolig			
Schutzschalter-Verriegelung E203, universell			
Schutzschalter-Verriegelung D01+D02 E218			
Schutzschalter-Verriegelung D01+D03 E233			
Schutzschalter-Verriegelung D01+D04 E235			
Schutzschalter-Verriegelung D01+D05 E237			
Schutzschalter-Verriegelung D01+D06 E239			
Schutzschalter-Verriegelung D01+D07 E241			
Schutzschalter-Verriegelung D01+D08 E243			
Schutzschalter-Verriegelung D01+D09 E245			
Schutzschalter-Verriegelung D01+D10 E247			
Schutzschalter-Verriegelung D01+D11 E249			
Schutzschalter-Verriegelung D01+D12 E251			
Schutzschalter-Verriegelung D01+D13 E253			
Schutzschalter-Verriegelung D01+D14 E255			
Schutzschalter-Verriegelung D01+D15 E257			
Schutzschalter-Verriegelung D01+D16 E259			
Schutzschalter-Verriegelung D01+D17 E261			
Schutzschalter-Verriegelung D01+D18 E263			
Schutzschalter-Verriegelung D01+D19 E265			
Schutzschalter-Verriegelung D01+D20 E267			
Schutzschalter-Verriegelung D01+D21 E269			
Schutzschalter-Verriegelung D01+D22 E271			
Schutzschalter-Verriegelung D01+D23 E273			
Schutzschalter-Verriegelung D01+D24 E275			
Schutzschalter-Verriegelung D01+D25 E277			
Schutzschalter-Verriegelung D01+D26 E279			
Schutzschalter-Verriegelung D01+D27 E281			
Schutzschalter-Verriegelung D01+D28 E283			
Schutzschalter-Verriegelung D01+D29 E285			
Schutzschalter-Verriegelung D01+D30 E287			
Schutzschalter-Verriegelung D01+D31 E289			
Schutzschalter-Verriegelung D01+D32 E291			
Schutzschalter-Verriegelung D01+D33 E293			
Schutzschalter-Verriegelung D01+D34 E295			
Schutzschalter-Verriegelung D01+D35 E297			
Schutzschalter-Verriegelung D01+D36 E299			
Schutzschalter-Verriegelung D01+D37 E301			
Schutzschalter-Verriegelung D01+D38 E303			
Schutzschalter-Verriegelung D01+D39 E305			
Schutzschalter-Verriegelung D01+D40 E307			
Schutzschalter-Verriegelung D01+D41 E309			
Schutzschalter-Verriegelung D01+D42 E311			
Schutzschalter-Verriegelung D01+D43 E313			
Schutzschalter-Verriegelung D01+D44 E315			
Schutzschalter-Verriegelung D01+D45 E317			
Schutzschalter-Verriegelung D01+D46 E319			
Schutzschalter-Verriegelung D01+D47 E321			
Schutzschalter-Verriegelung D01+D48 E323			
Schutzschalter-Verriegelung D01+D49 E325			
Schutzschalter-Verriegelung D01+D50 E327			
Schutzschalter-Verriegelung D01+D51 E329			
Schutzschalter-Verriegelung D01+D52 E331			
Schutzschalter-Verriegelung D01+D53 E333			
Schutzschalter-Verriegelung D01+D54 E335			
Schutzschalter-Verriegelung D01+D55 E337			
Schutzschalter-Verriegelung D01+D56 E339			
Schutzschalter-Verriegelung D01+D57 E341			
Schutzschalter-Verriegelung D01+D58 E343			
Schutzschalter-Verriegelung D01+D59 E345			
Schutzschalter-Verriegelung D01+D60 E347			
Schutzschalter-Verriegelung D01+D61 E349			
Schutzschalter-Verriegelung D01+D62 E351			
Schutzschalter-Verriegelung D01+D63 E353			
Schutzschalter-Verriegelung D01+D64 E355			
Schutzschalter-Verriegelung D01+D65 E357			
Schutzschalter-Verriegelung D01+D66 E359			
Schutzschalter-Verriegelung D01+D67 E361			
Schutzschalter-Verriegelung D01+D68 E363			
Schutzschalter-Verriegelung D01+D69 E365			
Schutzschalter-Verriegelung D01+D70 E367			
Schutzschalter-Verriegelung D01+D71 E369			
Schutzschalter-Verriegelung D01+D72 E371			
Schutzschalter-Verriegelung D01+D73 E373			
Schutzschalter-Verriegelung D01+D74 E375			
Schutzschalter-Verriegelung D01+D75 E377			
Schutzschalter-Verriegelung D01+D76 E379			
Schutzschalter-Verriegelung D01+D77 E381			
Schutzschalter-Verriegelung D01+D78 E383			
Schutzschalter-Verriegelung D01+D79 E385			
Schutzschalter-Verriegelung D01+D80 E387			
Schutzschalter-Verriegelung D01+D81 E389			
Schutzschalter-Verriegelung D01+D82 E391			
Schutzschalter-Verriegelung D01+D83 E393			
Schutzschalter-Verriegelung D01+D84 E395			
Schutzschalter-Verriegelung D01+D85 E397			
Schutzschalter-Verriegelung D01+D86 E399			
Schutzschalter-Verriegelung D01+D87 E401			
Schutzschalter-Verriegelung D01+D88 E403			
Schutzschalter-Verriegelung D01+D89 E405			
Schutzschalter-Verriegelung D01+D90 E407			
Schutzschalter-Verriegelung D01+D91 E409			
Schutzschalter-Verriegelung D01+D92 E411			
Schutzschalter-Verriegelung D01+D93 E413			
Schutzschalter-Verriegelung D01+D94 E415			
Schutzschalter-Verriegelung D01+D95 E417			
Schutzschalter-Verriegelung D01+D96 E419			
Schutzschalter-Verriegelung D01+D97 E421			
Schutzschalter-Verriegelung D01+D98 E423			
Schutzschalter-Verriegelung D01+D99 E425			
Schutzschalter-Verriegelung D01+D100 E427			
Schutzschalter-Verriegelung D01+D101 E429			
Schutzschalter-Verriegelung D01+D102 E431			
Schutzschalter-Verriegelung D01+D103 E433			
Schutzschalter-Verriegelung D01+D104 E435			
Schutzschalter-Verriegelung D01+D105 E437			
Schutzschalter-Verriegelung D01+D106 E439			
Schutzschalter-Verriegelung D01+D107 E441			
Schutzschalter-Verriegelung D01+D108 E443			
Schutzschalter-Verriegelung D01+D109 E445			
Schutzschalter-Verriegelung D01+D110 E447			
Schutzschalter-Verriegelung D01+D111 E449			
Schutzschalter-Verriegelung D01+D112 E451			
Schutzschalter-Verriegelung D01+D113 E453			
Schutzschalter-Verriegelung D01+D114 E455			
Schutzschalter-Verriegelung D01+D115 E457			
Schutzschalter-Verriegelung D01+D116 E459			
Schutzschalter-Verriegelung D01+D117 E461			
Schutzschalter-Verriegelung D01+D118 E463			
Schutzschalter-Verriegelung D01+D119 E465			
Schutzschalter-Verriegelung D01+D120 E467			
Schutzschalter-Verriegelung D01+D121 E469			
Schutzschalter-Verriegelung D01+D122 E471			
Schutzschalter-Verriegelung D01+D123 E473			
Schutzschalter-Verriegelung D01+D124 E475			
Schutzschalter-Verriegelung D01+D125 (Spolig) P600			

LOCKPOINT – THE STORAGE SYSTEM

Having direct access to all necessary materials and documents is a challenge for every company. The solution: flexible, adjustable, adaptable – the ABUS LockPoint. Thanks to the optional frame, the LockPoint is always where you need it – directly at your machine. Made out of solid steel, it is perfect for use in industrial environments.



LockPoint SingleWall | 82629

LOCKPOINT SINGLEWALL



incl. wall mount

Designated for:



LOCKPOINT

+ wall bracket, feet or double rollers
(Please specify version when ordering)

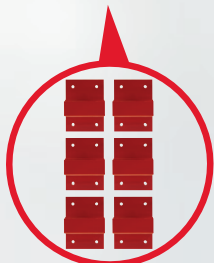

Wall mount | 77944

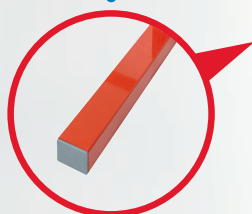

LockPoint feet RL | 77952



LockPoint frame with double rollers | 77963

TECHNOLOGY & DETAILS

- Modular system for storing lockout/tagout locks and locking devices
- Stable, durable and easy-to-clean metal storage solution
- Customisable design according to customer's wishes for every LockPoint
- 2 different sizes and 3 variants
- The LockPoint can be combined with documents, work instructions, permit-to-work procedures and group processes
- Complies with the 60-second rule, whereby all materials should be available within one minute

THE ADDED VALUE FOR YOU

Any work environment in the lockout/tagout area can be purposefully and efficiently designed due to the modular design of the ABUS LockPoint. You have the option to attach padlock traverse bars, baskets with optional basket separators or even document holders. The LockPoint thus becomes your very own safety centre.

To the LockPoint video



Item	Description	Combi- nable	EAN 4003318
------	-------------	-----------------	----------------

LOCKPOINT ●

LockPoint basic set	Consists of: Two-piece perforated wall, two-piece side stands, 1 x "LockPoint" display attachment, 1 x "LockPoint" insert, 1 x traverse lock store for up to 20 locks	●	77966
---------------------	---	---	-------

+ VERSION (important: Specify when selecting the LockPoint basic set)

LockPoint wall mount	Set consists of 6 wall mounts including bolts for the LockPoint	●	77944
LockPoint feet RL set, two-piece	Two-part standing feet set R/L for the LockPoint	●	77952
LockPoint chassis with double rollers	Two-part roller frame for the LockPoint	●	77963

LOCKPOINT SINGLEWALL ●

LockPoint SingleWall basic set	Consists of: one-piece perforated wall, two-piece side stands, 1 x "LockPoint" decal 1 x traverse lock store, 4 x wall mounts with bolts	●	82629
--------------------------------	---	---	-------

+ PRODUCT LEVEL OPTION

LockPoint padlock rack	Lock store for up to 20 locks, height-adjustable	● ●	77947
LockPoint basket	Product chute (internal and external basket)	●	77948
LockPoint basket compartment 40 cm	Product chute dividers	●	77949
LockPoint basket for the SingleWall	Product chute (half depth for SingleWall)	●	82625

+ ORGANISATIONAL LEVEL OPTION

LockPoint flop frame pocket set A4	Set with 10 pcs (5 x blue, 5 x red) removable document pockets for DIN A4 paper	● ●	77953
LockPoint flip frame display	Bracket for up to 10 document pockets	● ●	77964
LockPoint desk pad	Height-adjustable DIN A4 writing pad	●	77946
Hook for isolator switch locking devices (Eurocode)	Insertable hook for storing hasps like H701 etc.	● ●	28246
Holder tag dispenser	LockPoint holder for LOTO tag dispenser boxes	● ●	86796

ABUS SUPPORTBOX



In order to simplify distribution of your individual safety padlocks to employees, ABUS has developed an innovative form of packaging: the ABUS SupportBox.

Thanks to the unique lock packaging, you can instantly see which lock should be assigned to which employee and which machine – this significantly reduces the amount of organisational work you have to do.

You can add the ABUS SupportBox as an alternative form of packaging from an order quantity of 100 locks.

ABUS TRAININGSTOWER



Front of the TrainingsTower



Back of the TrainingsTower



The ABUS TrainingsTower offers realistic, practical lockout/tagout training. It is suitable for yearly instruction, follow-up training or general briefing and instruction of outside companies, for example.

The ABUS TrainingsTower gives you the option of covering both simple and complex LoTo processes. Electrical and mechanical energy points are included for this purpose.

Training can therefore be successfully conducted outside of normal operations.

Your ABUS TrainingsTower is ready and waiting, we will be happy to advise you.

ABUS EMMA



Are you planning an event to remember and wish to present the topic of occupational safety?
With ABUS, you can turn your event into a show and allow your employees to experience Lockout/Tagout!

Our mighty 650 kg lady "EMMA" offers you the chance to simulate everyday isolating procedures in a fun,
playful way. The mechanical and electrical energy sources are secured under steam and acoustics.
If everything runs on time, we also have a wonderful competition known to awaken participants' ambition.

In addition, a guide/moderator is always provided alongside EMMA. We would be delighted to help you
plan your next show.

Simply contact us!



START NOW – LOOK AFTER YOUR EMPLOYEES AND PROTECT THEIR HEALTH!

WE WILL BE THERE TO HELP YOU.

ABUS LOCKOUT/TAGOUT WITH SYSTEM. ON THREE PILLARS.

1. Series 76, 74 and 72: the perfect safety lock for all applications. For clear, non-verbal communication.
2. Locking devices: For large-scale systems, main switches, handwheels, valves, fuses, control panels and plugs.
3. Storage and organisation: Thanks to the ABUS LockPoint, all materials are ready to hand within 60 seconds. All important information in one place. Group lockout process: with the B835 Safety Redbox™ and B10 Permit Redbox™, you can efficiently and securely organise the group lockout.

ABUS | August Bremicker Söhne KG
abus.com

Altenhofer Weg 25
58300 Wetter
Germany
+49 23 35 634-0
info@abus.de